



Performance
Automotive Gaskets
Domestic and Import



Gasket Development

Cometic provides customers with quality products, born of exhaustive research and development.

Cometic's Superflow 902S Dynamometer positions us at the forefront of gasket design and technology by giving us the ability to analyze gasket designs and materials in the most extreme conditions. Alongside our in-house research and development, we also collaborate with our partners racing on Sunday at the highest level, ensuring that your gasket won't fail when you need it most.



Custom Gaskets

Need to change a gasket bore size? Thickness or both? Do you need a complete gasket design and execution? The process starts with a simple phone call.

Cometic's in-house technical sales team can accommodate virtually any engine configuration: from naturally aspirated to the most exotic turbo or nitrous injected engines. Our commitment is to provide innovative, quality gaskets while maximizing your engine's power and performance. When customization is vital, Cometic delivers!

How does Cometic do it? The process starts and ends under one roof in Concord, Ohio. Once the technical sales team understands your needs, design engineers draw the gasket with state-of-the-art software, and then it is off to manufacturing. Your gasket is efficiently manufactured from quality materials and then shipped. If special tooling is required, Cometic will provide a pre-production estimate for approval.

The passion for racing runs deep in our technical sales and engineering teams. We understand the importance of perfection in your next engine build because we are right there with you racing on weekends.



OEM Production Gaskets

Cometic is your one source for OEM gaskets, from prototyping to full production.



We currently develop sealing solutions in nearly every environment for many customers in the automotive, marine, powersports, industrial, and power generator industries. Prototyping is essential and economical with our different tooling options and quick turnaround due to our in-house tool and die department. Not only are we ISO 9001:2008 Certified, but we also have stamping, laser cutting, rubber injecting molding, and 5-axes machining capabilities.



Flexibility and communication are key. Cometic understands that many variables in determining the design, volume, and production forecasts. We are accustomed to working in an ever-changing environment, maintaining knowledge base and part awareness during the transition from the early stages of development through production, without the hassle of changing suppliers. Inventory turns are essential. We can work together for a delivery solution that best fits your inventory level and cash flow needs.



Partner Relationships

Cometic's gaskets are the industry standard for championship-winning teams and engine builders across multiple disciplines of both professional and amateur motorsports. Since its inception in 1989, Cometic has built relationships with the most reputable engine builders in the industry. Those relationships create the foundation on which Cometic's gaskets are engineered, validated and manufactured for everyday use, or in the most competitive and demanding environments.





Automotive Gaskets

Cometic Gasket - An Exclusive NASCAR Performance Product

Carburetor Gaskets

Designed by engineers, validated by the winner's circle. Cometic carburetor gaskets are manufactured from performance grade materials that resist swelling from various types of fuel. Can be custom ordered to your exact specifications.

Part #	Application	Material	List
C15184	Holley 2bbl Carb Open Plenum	.039" FIBER	\$7.49
C5282	Holley 2bbl Carb 2 Hole 1.750"	.047" FIBER	\$5.44
C5263	Holley 4150 4bbl Carb Open Plenum	.047" FIBER	\$5.96
C5262	Holley 4150 4bbl 4 Hole 1.750"	.047" FIBER	\$5.96
C15238	Holley 4500 4bbl Carb Open Plenum	.047" FIBER	\$9.00
C15239	Holley 4500 4bbl 4 Hole 1.750" Gasket	.047" FIBER	\$5.96
C5280	Holley 390 Cfm 4bbl Carb 4 Hole 1-19/32"	.047" FIBER	\$5.96
C15181	Carter Afb 4bbl Square Bore 4 Hole	.039" FIBER	\$7.49
C15183	Rochester Quadrajets 4bbl Spread Bore	.039" FIBER	\$7.49
C15240	Weber 48mm Carb	.047" FIBER	\$3.65
C5388	Holley Airhorn Carb	.060" FIBER	\$3.09
C15241	Holley Float Bowl	.062" MP	\$6.77
C15242	Holley 2 Circuit Metering Block	.062" MP	\$6.77
C15243	Holley 3 Circuit Metering Block	.062" MP	\$6.77
C15244	Holley/Quik Fuel Power Valve	.062" MP	\$1.11



Differential Gaskets

Cometic Differential Gaskets are offered for the most popular differentials in the industry. Made from performance inspired materials and engineered to be the best sealing gasket you can find. Don't see what you are looking for? Simply send us your used gasket and we can custom make exactly what you need.

Part #	Application	Material	List
C14006-060	Nissan Titan XD	.060" AFM	\$26.73
C15212	AMC 12 Bolt	.125" FIBER	\$11.87
C15213	Dana 25,27,30 10 Bolt	.032" AFM	\$8.87
C15214	Dana 35 10 Bolt	.060" AFM	\$9.56
C15215	Dana 44	.060" AFM	\$16.47
C15216	Dana 44/GM 8.75" Corvette/Viper	.032" AFM	\$6.67
C15217	Dana 60/70	.060" AFM	\$16.47
C15218	Dana 80 10 Bolt	.032" AFM	\$12.16
C15219	Dodge 7.25" 10 Bolt Front Axle	.032" AFM	\$10.42
C15220	Dodge 8.25" 10 Bolt Rear Axle	.032" AFM	\$8.73
C15221	Ford 10.5" 12 Bolt	.032" AFM	\$6.67
C15222	Ford 8" 10 Bolt	.032" AFM	\$7.70
C15223	Ford 8.8" 10 Bolt	.060" AFM	\$20.30
C5848-032	Ford 9" 10 Bolt	.032" AFM	\$20.30
C15225	Ford 9.75" 12 Bolt	.060" AFM	\$12.38
C15226	GM "O" Axle 12 Bolt Irregular	.060" AFM	\$10.43
C15227	GM 1/2 Ton 12 Bolt	.032" AFM	\$6.67
C15228	GM 12 Bolt	.060" AFM	\$10.43
C15229	GM 7.5" 10 Bolt Rear Axle	.032" AFM	\$6.67
C15230	GM 7.75" 9 Bolt Front Axle	.032" AFM	\$8.87
C15231	GM 8.5" 1/2 & 3/4 Ton 10 Bolt	.032" AFM	\$6.67
C15232	GM 8.5" 10 Bolt	.060" AFM	\$9.88
C15233	GM 9.5" 1/2 & 3/4 Ton 14 Bolt	.060" AFM	\$13.59
C15234	GM Truck 14 Bolt	.060" AFM	\$13.59
C15235	Legend Car 10 Bolt	.032" AFM	\$14.74
C15236	Sprint Midget 10-Bolt Quick Change	.060" AFM	\$11.75
C15237	Winter Quick Change 10 Bolt	.060" AFM	\$9.17



Transmission Gaskets

Why trust your expensive transmission to some flimsy paper gasket? Keep your transmission fluid and gear lube where it belongs with our Aluminum Foamet Material (AFM) Gaskets. AFM consists of an aluminum core and features a foam rubber coating bonded to both sides. Ideal for sealing less than perfect surfaces and can be installed without the use of additional sealers!

Part #	Application	Material	List
C15246	Dodge 727/46RE Pan	.060" AFM	\$19.23
C15247	Ford A4LD/4R44E/4R55E 1993-05	.060" AFM	\$19.23
C15248	Ford C-4/C-5 11 Bolt 1970-86	.060" AFM	\$19.23
C15249	Ford C-6 3 Speed 17 Bolt	.060" AFM	\$19.23
C15250	GM 4L80E 1991-10	.060" AFM	\$19.23
C15251	GM TH700-R4/4L60E 1982-03	.060" AFM	\$19.23
C15252	GM Powerglide 2Spd Trans Pan	.075" AFM	\$19.23
C15253	GM Turbo 400 Trans Pan	.075" AFM	\$19.23
C15254	GM Turbo 350 Pan Trans	.075" AFM	\$19.23
C15255	Muncie M21 Gasket Kit - No Seals	AFM	\$32.08
C15469	DOD/CHRY/AMC 904 Torqueflite	.060" AFM	\$19.23
C15265	Dodge TorqueFlite 8	.075" AFM	\$37.60

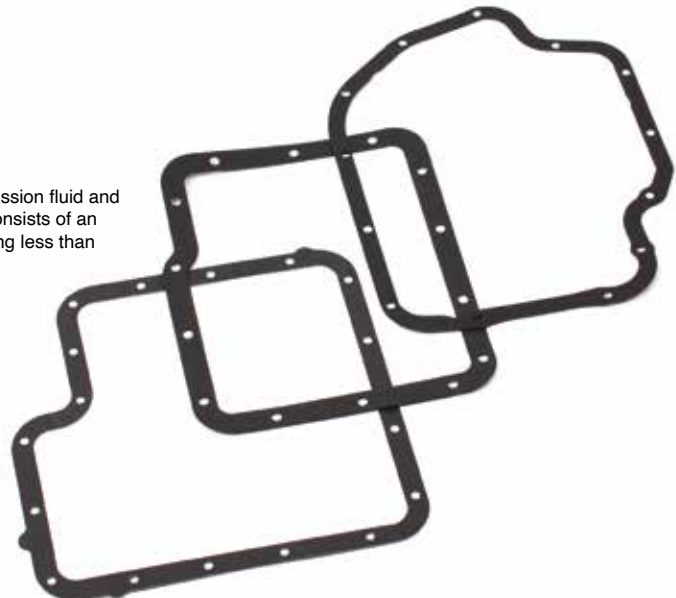

Valve Cover Gaskets & Sets

Race inspired designs and materials ensure that these valve cover gaskets will perform well above the OE standard. Cosmetic valve cover gaskets surpass the quality and ability of typical cork or paper gaskets offered by other manufactures. Withstands blowing out, over tightening, and high vacuum all at an affordable price.

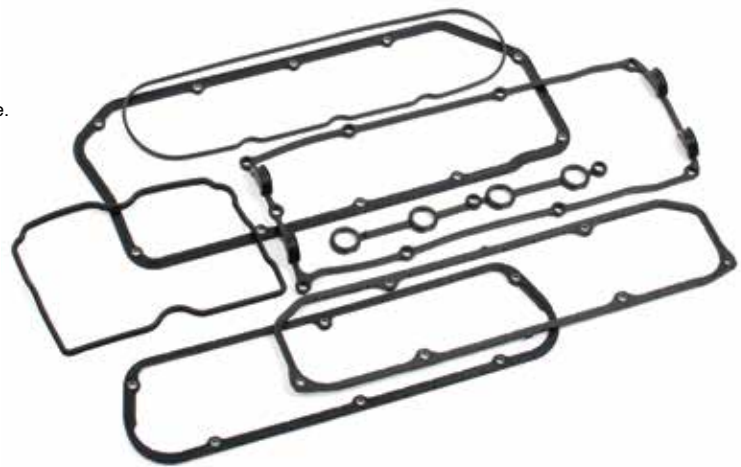

DOMESTIC

Part #	Application	List
C15579	Buick 400/430/455 1967-76	\$30.85
C15438	Chevy LT1/LT4 5.3L/6.2L 2014-2017	\$29.73
C5976	Chrysler 426 Hemi V8	\$23.56
C5983	Chrysler Big Block Wedge	\$23.56
C15468	Chrysler 318/340/360 LA V8 1964-1992	\$30.85
C5193	Chrysler/Dodge 5.7/6.1L Hemi 2003+Up Set - 1 Head	\$17.66
C5177	Ford 4.6L DOHC 1996-98	\$70.69
C5178	Ford 4.6L SOHC 1996-04	\$47.12
C5179	Ford 4.6L SOHC 2002-04 Truck	\$47.12
C5974	Ford Small Block 289,302,351W	\$17.66
C15467	Ford 429/460 Big Block V8	\$32.91
C15442	Ford 5.0L 2014-2017 / 5.2L 2015-2018 Set	\$109.20
C5975	GM Big Block Mark 4/5/6	\$23.56
C15245	GM LS V8 Gen 3/4 1999-14	\$23.56
C5973	GM Small Block 18/23* V8	\$23.56
C15440	Olds 330/350/400/403/455	\$23.56
C5044	Pont 265/301/350/400/428/455	\$23.56

SPORT COMPACT

Part #	Application	List
C4643	Ford Zetec 2.0L DOHC 1995-97 / Set	\$29.44
C4644	Ford Zetec 2.0L DOHC 1998-04 / Set	\$29.44
C15445	Ford Focus ST 2.0L/2.3L 2012-2018	\$36.50
C4653	Ford 2300 2.3L SOHC 1974-93 / Set	\$23.56
C4701	Honda D15B1/D15B2/D15B7/D16A6/D16A7 88-95 / Set	\$32.98
C4628	Honda B16A2/3, B17A1, & B18C1/C5 94-01 / Set	\$23.56
C4665	Honda D16B5 & D16Y5/7/8 96-00 / Set	\$23.56
C4655	Honda D16Z6 VTEC 92-95 / Set	\$29.44
C4706	Honda D16A1/D16A8/D16A9 86-89 / Set	\$32.98
C4679	Honda B18A1/B1 1990-01 / Set	\$23.56
C14111	Honda L15B7	\$21.41
C14012	Honda K20/K23/K24	\$14.55
C4781	Mazda B6ZE 1.6L 1989-93 / Set	\$23.56
C4788	Mazda MX-6 FS-DE 2.0L 91-97 / Set	\$29.44
C4722	Mitsubishi 6G72 DOHC 24V 3.0L 91-99 / Set	\$47.12
C4691	Mitsubishi 4G63/4G63T 2.0L 90-99 / Set	\$40.05
C4713	Mitsubishi 6G72 SOHC 24V 3.0L 88-96 / Set	\$62.39
C15046	Mitsu/Dodge 2.0L 420A/ECC 95-99 / Set	\$23.56
C4607	Nissan CA16DE/CA18DE/CA18DET 1987-1993 / Set	\$23.56
C4906	Nissan E13/E15/E16 1982-89 / Set	\$17.66
C4631	Nissan KA24DE-A 2.4L 1993-01 Fwd / Set	\$29.44
C4761	Nissan KA24DE 2.4L DOHC 1990-94 / Set	\$23.56
C4766	Nissan KA24DE 2.4L DOHC 1995-04 / Set	\$23.56
C4552	Nissan RB20/25/26 1988-02 / Set	\$35.34
C4730	Nissan SR16VE/SR20VE/SR20DE 97-02 Fwd / Set	\$41.23
C4747	Nissan SR20DE Fwd, SR20DET Awd 91-96 / Set	\$29.44
C4753	Nissan SR20DE/SR20DET S13 DOHC 88-93 Rwd / Set	\$23.56
C4755	Nissan SR20DE/SR20DET S14/S15 DOHC 94-98 Rwd / Set	\$23.56

SPORT COMPACT

Part #	Application	List
C4773	Nissan VG30DE/VG30DETT 3.0L V6 90-99 / Set	\$29.44
C4871	Subaru EJ22E SOHC 90-96 / Set	\$32.98
C4880	Subaru EJ255 06-Up, EJ257 08-Up / Left	\$23.56
C4881	Subaru EJ255 06-Up, EJ257 08-Up / Right	\$23.56
C4873	Subaru EJ25D DOHC 96-99 / Set	\$47.12
C4863	Subaru WRX EJ205 02-05 / Right	\$32.98
C4864	Subaru WRX EJ205 02-05 / Left	\$32.98
C4642	Subaru EJ251 SOHC 1999-05 / Set	\$35.34
C4928	Subaru EJ257 DOHC 2004-07 / Left	\$23.56
C4929	Subaru EJ257 DOHC 2004-07 / Right	\$23.56
C4935	Toyota 20R/22R/22R-E 75-85 / Set	\$17.66
C4830	Toyota 2RZ-FE/3RZ-FE 4 Cyl 95-04 / Set	\$23.56
C4807	Toyota 4A-GE/4A-GEZ 1.6L 16-Valve 84-92 / Set	\$18.84
C4820	Toyota 5S-FE 2.2L 4 Cyl 90-97 / Set	\$27.09
C4851	Toyota Supra 2JZ-GE/2JZ-GTE 93-98 / Set	\$35.34
C4838	Toyota Supra 7M-GE/7M-GTE 86-92 / Set	\$23.56
C4608	Toyota 3S-GTE 1990-1995 / Set	\$38.88

DIESEL

Part #	Application	List
C15056	Cummins 3.9L 4Bt 4Cyl Diesel / Set	\$22.56
C5614	Cummins 5.9L 24V Diesel 1998.5-02 / Set	\$92.79
C15066	Cummins 5.9L 12V Diesel 1992-98 / Set	\$41.23
C15070	Cummins 5.9L 24Vcr Diesel 2003-07 / Set	\$41.23
C15143	Ford 6.0L Power Stroke 2003-08 / Set	\$23.56
C15151	Ford 6.4L Power Stroke 2008-10 / Set	\$35.34
C15162	Ford 7.3L Power Stroke 1994-97 / Each	\$58.91
C15163	Ford 7.3L Power Stroke 1998-03 / Each	\$82.47

Turbo Gaskets

Manufactured from a high grade stainless steel, these turbocharger gaskets get the job done the first time! The embossed spring steel maintains a torque set and won't burn through or push out. Does not require additional sealers.



Part #	Application	Material	List
C15585	Turbo Inlet Flange Gasket, T3/GT30R	.016" Stainless	\$12.99
C15586	Turbo Inlet Flange Gasket, T3 Divided	.016" Stainless	\$12.99
C15584	Turbo Inlet Flange Gasket, T4 Rectangular	.016" Stainless	\$12.99
C15590	Turbo Inlet Flange Gasket, T04 Divided	.016" Stainless	\$18.67
C15587	Turbo Inlet Flange Gasket, T25/T28/GT25	.016" Stainless	\$12.99
C15589	Turbo Inlet Flange Gasket, T06	.016" Stainless	\$12.99
C15588	Turbo Inlet Flange Gasket, T06 Divided	.016" Stainless	\$18.67
C15591	Turbo Inlet Flange Gasket, GT30R/GT35R/GT40R	.016" Stainless	\$12.99

Part #	Application	Material	List
C15596	Discharge Flange Gasket, GT Series 2.5"	.016" Stainless	\$12.99
C15595	Discharge Flange Gasket, GT Series 3"	.016" Stainless	\$18.67
C15594	Discharge Flange Gasket, GT32 6 Bolt	.016" Stainless	\$19.71
C15593	Discharge Flange Gasket, K03/K04 4 Bolt	.016" Stainless	\$18.67
C15592	Wastegate Flange Gasket, Tial Style	.016" Stainless	\$8.62
C5723-030	Subaru WRX Turbo To Up Pipe		\$9.41
C5736-030	Subaru WRX Turbo To Downpipe		\$9.41
C15154	Ford 6.4L Power Stroke 2008-10, Mounting Kit		\$76.58

Valve Stem Seals

New age engine builds require new age valve stem seals and we have them! These viton steel body (VSB) seals are available for most applications ranging from automotive to off road dirt bikes. Sold in packs of 16. [See page 150 for additional Valve Stem Seals](#)

Part#	Valve Stem O.D.	Guide O.D.	Height	Overall O.D.	List
3262V-16	7mm	11mm	9.5mm	14.4mm	\$28.34
3516P-16	8mm	.492"	.470"	.616"	\$27.62
3237V-16	5/16"	.500"	.517"	.562"	\$26.92
3235V-16	5/16"	.531"	.516"	.677"	\$32.44
3188V-16	11/32"	.500"	.531"	.623"	\$30.13
3228V-16	11/32"	.530"	.527"	.674"	\$34.04
3195V-16	3/8"	.500"	.531"	.623"	\$28.69
3198V-16	3/8"	.625"	.531"	.742"	\$32.44





2 Pc Viton Rear Main Seals

Description	Part #	List
Buick W / Side Rails 196,231,252.....	C5707	\$19.00
Chevy 283-400.....	C5680	\$25.52
Chevy BB 396-454.....	C5682	\$30.59
Chrysler 273,318,340.....	C5683	\$33.23
Chrysler 360.....	C5684	\$30.59
Chrysler 361-440 & Hemi.....	C5686	\$34.91
Ford 289,302.....	C5688	\$29.35
Ford 351C,351M,351W.....	C5689	\$31.11



Engine Crankshaft Seals Wet & Dry Sump Applications

Description	Signal Part #	TTS Part #	Cometic Part #	List
JESEL Small Block Crank B/Drive F.C..	86587	T-13527	C5376	\$46.80
JESEL Big Block Crank B/Drive F.C.....	86622	T13553 Rev.B...	C5377	\$63.51
JESEL (SEL 38000) Cam.....	86586	T13561 Rev.B...	C5435	\$51.40
Aluminum GM Sprint 400 Main.....	86410	T-13675	C5672	\$86.58
Chevy Small Block Rear Split Seal.....	86625	T-13675-DL	C5379	\$61.01
Chevy BB Rear Double Split Seal 2 PC	86665	T-13676-DS	C5381	\$53.77
Chevy BB Rear Single Split Seal.....	86665	T-13676-SS	C15560	\$53.77
Dodge R5 Small Block Rear Crank.....	14255	T-14255	C5396	\$65.83
Ford Rear Crankseal W/302 Crank.....	85742	T-13584	C5384	\$101.76
Ford Rear Crankseal 302.....	13610	T-13610	C5385	\$80.29
Ford Front Crankseal 302 & 351.....	85338	T-13690	C5386	\$61.22
Ford R.R. Crankseal 351.....	85339	T-14053	C5391	\$75.35
Ford 351 Front Crank Yates Drive.....	85741	T-14276	C5490	\$98.34
GM Small Block Front Crankseal.....	86990	T-13852	C5378	\$64.34

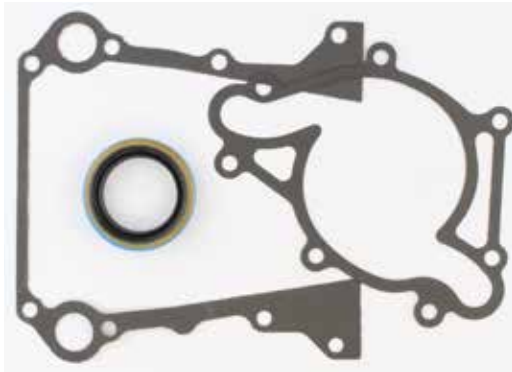

Timing Cover Gasket Sets

Description	Part #	List
AMC 290-401 V8 66-88.....	C5046	\$17.66
AMC 4/6 Cyl 2.5/3.8/4.0/4.2L 65-06.....	C5047	\$17.66
Buick V6/Small V8 66-87 (Rope Seal).....	C5048	\$23.56
Buick V6/Small V8 66-87 (Radial Seal).....	C5049	\$17.66
Buick 400/430/455 V8 67-74.....	C5050	\$17.66
GM Small Block V8/V6 75-95 (Thick Front Seal).....	C5051	\$17.66
GM Small Block V8 57-74 (Thin Front Seal).....	C5052	\$17.66
GM 4/6 Cyl 151/230/250/192 63-89.....	C5053	\$17.66
GM Small Block LT1 V8 92-94.....	C5054	\$17.66
GM Small Block LT1 V8 94-97.....	C5055	\$23.56
GM Small Block LS V8 97-Up.....	C5056	\$41.23
GM Big Block V8 65-95.....	C5057	\$19.75
GM Big Block V8 96-00.....	C5058	\$17.66
Chrysler Magnum V6/V8 92-96.....	C5059	\$23.56
Chrysler Magnum V6/V8 97-03.....	C5060	\$23.56
Chrysler LA Small Block V6/V8 64-91.....	C5061	\$29.44
Chrysler 5.7/6.1/6.2/6.4L Hemi 03-UP.....	C5202	\$41.23
Chrysler Wedge/426 Hemi V8 58-79.....	C5062	\$29.44
Chrysler Early Hemi V8 55-59.....	C5063	\$29.44
Ford Small Block V8 62-78.....	C5064	\$25.92
Ford Small Block V8 79-97.....	C5065	\$25.92
Ford 351C/351M/400 V8 70-81.....	C5066	\$23.56
Ford 352/360 FE V8 58-60.....	C5067	\$23.56
Ford 332-428 FE V8 61-71.....	C5068	\$23.56
Ford 429/460 Big Block 68-85.....	C5069	\$23.56
Olds 260-455 V8 64-90.....	C5070	\$23.56
Pontiac 265-455 V8 63-81.....	C5071	\$29.44

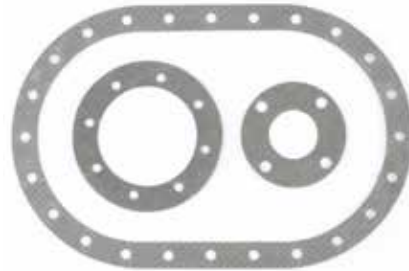

Fuel Cell Gasket Kit

Description	Part #	List
Vent Neck Gasket .059" CFM20.....	C5507	\$52.47
8 Bolt Vent Gasket .059" CFM20, Fill Plate Gasket .059" CFM20		



Sheet Materials

Part #	Description	List
C15180HTS.....	10" X 10" X .060" HTS.....	\$16.06
C15346FC.....	24" X 6" X .060" FC.....	\$13.92
C15346HTS.....	24" X 6" X .060" HTS.....	\$24.63
C15346TNG.....	24" X 6" X .060" TNG.....	\$19.92
C15354F.....	36" X 9" X .031" Fiber.....	\$16.02
C15358TNG.....	12" X 12" X .060" TNG.....	\$13.92
C15384.....	10" X 26" X 1/16" CORK/RUBBER (w/Cutting Tool).....	\$10.70
C15385.....	10" X 26" X 1/32" Fiber (w/Cutting Tool).....	\$10.70

ATI Damper Re-build Viton O-Rings

Description	Part #	List
6" Damper Rebuild Kit (3-Ring).....	C5393	\$88.40
7" Damper Rebuild Kit (3-Ring).....	C5982-070	\$88.40
6" Damper Rebuild Kit (4-Ring).....	C5632	\$110.50



TABLE OF CONTENTS

MLS

Multi Layer Steel

MLS Gaskets are comprised of multiple embossed layers of both AMP (Advanced Multi-Polymer Coating) and uncoated stainless steel. The embossed outer layers of the gaskets meet the demands of a variety of harsh sealing environments, load conditions and surface finishes. Requires less clamp load creating less bore distortion and conforms load distribution across the sealing area. The center or shim layer is an uncoated stainless steel layer which can be varied to accommodate multiple thickness requirements.

No sealants or re-torque required.



3 Layer **MLS** Style Cross Section

Available thickness:

.027", .030", .036", .040", .045", .051", .056", .060", .066", .070", .075", .080", .086", .092", .098", 120", .140"

MLS Head Gaskets

Make	Pg.
AMC	6
AUSTIN	72
BMW	73
BUICK	6
CADILLAC	8
CHEVROLET / GM	9, 86
CHEVROLET DIESEL	26
CHRYSLER / DODGE	27
COVENTRY CLIMAX	79
CUMMINS	41, 128
FERRARI	79
FIAT / LANCIA	80
FORD	46
FORD / LOTUS	80
HOLDEN	87
HONDA / ACURA	87
HYUNDAI	100
JAGUAR	101
MAZDA	105
MERCEDES BENZ	108
MG	109
MINI	109
MITSUBISHI	110
NISSAN	113
OLDSMOBILE	70
PEUGEOT/CITROEN	129
PONTIAC	71
PORSCHE	129
RENAULT	132
ROVER	132
SAAB	133
SUBARU	133
TOYOTA	146
TRIUMPH	157
TVR	157
VAUXHALL/OPEL	158
VOLKSWAGEN/AUDI	158
VOLVO	161

MLX Head Gaskets

Application	Pg.
Ecotec 4 Cylinder	9, 86
3.6L LY7/LLT/LFX	11
4.2L Inline 6 LL8 Vortec 4200	12
18/23 Degree SBC	12
SBC w/All Pro Heads, Dart/Brodix	14
Chevy R07.2	15
LS1/LS2/LS3/LS6	16
LS7, LS9/LSA	18
LS Next Block, LSX	19
Gen-4 Chevy Big Block V8	22
LT1 6.2L	21
GM 5.2 Prostock	25
6.6L Duramax	26
2.4L DOHC Turbo 4 Cylinder	28
5.7L Hemi	31
6.1L Hemi	33
6.2L Hellcat, 6.4L Apache, 7.0L Drag Pack	34
Chrys/Dodge Big Block V8	37
Chrys/Dodge R6 V8	36
8.0/8.3L V10, 8.4L V10	40

MLX

Multi Layer Xtreme

MLX Gaskets utilize an integrated "stopper" layer for combustion chamber sealing and improved clamp load around the cylinder without increasing bore distortion. MLX technology can be found in the applications below and are made from the same materials as our MLS Head Gaskets.

No sealants or re-torque required.



3 Layer **MLx** Style Cross Section



4 Layer **MLx** Style Cross Section



5 Layer **MLx** Style Cross Section

MLX Head Gaskets

Application	Pg.
Cummins 3.9L 4BT	41
Cummins 5.9L 12v 6BT	42
Cummins 5.9L 24v ISB Inline	43
Cummins 5.9L CR	44
Cummins 6.7L	45
1.0L 2014-Up Fox EcoBoost	46
1.6L Duratec Ti-VCT 2011-16	46
Ford 2.7L EcoBoost	50
Ford 3.5L EcoBoost	50
Ford 4.6/5.4L SOHC/DOHC	53
Ford 5.0L Coyote	53, 54
Ford 5.8L Trinity V8	57
Ford Windsor SB V8	58
Ford New Boss 302 Block	61
Ford RY45 V8, FR9 V8	62
6.2L SOHC Raptor	66
Ford 6.8L V10	67
Ford Prostock Racing V8	66
Ford 6.0L Powerstroke	67
Ford 6.4L Powerstroke, Ford 6.7L Scorpion	68
7.3L Powerstroke	69
BMW N54B30 3.0/3.2L	77
BMW M50B25/28 2.5/2.8L	76
BMW N54B30 3.0L	77
BMW B58	77
BMW M5430L, N55B30A 3.0L Inline 6	77
Honda D Series	88
Honda B Series	91
Honda K Series	96
Honda H Series	98
Hyundai 2.0L & 3.8L DOHC V6	100
Jaguar AJ133 5.0L	104
Mazda MZR 2.3L DOHC	108
Mini 1.6L Turbo Prince	109
Mitsu EVO X 4B11T	112
Mitsu 2.0L 4G63/4G63T	110
Nissan 2.0L SR20DE/DET S14	118
Nissan GT-R VR38DETT	127
Nissan TB48DE, VK56DE 5.6L	128, 129
Rover 5.0L V8 LR-V8	133
Subaru FA20 DOHC	133
Subaru EJ205 DOHC	134
Subaru EJ22E SOHC	135
Toyota 2ZZ-GE 1.8L	148
Toyota 2JZ-GE/GTE 3.0L	153
Toyota B58 3.0L	154
Toyota 1FZ-FE 4.5L	156
Vauxhall/Opel 20XE/C20XE/X20LET	158
Volkswagen/Audi 1.8/ 2.0L 16V DOHC	160

Fel-Pro to Cometec Cross Reference

Fel-Pro to Cometec Cross Reference	Pg.
Fel-Pro to Cometec Cross Reference	164

STREETPRO

Top & Bottom End Gasket Kits
Cometic StreetPro Kits are geared toward the street rodder who is looking to purchase a kit with all necessary gaskets and seals needed for your rebuild.

STREET PRO KITS

Make	Pg.
BMW	73, 75
Buick	8
Chevrolet	11, 13, 17, 20, 22, 23
Chevrolet Diesel	26
Chrysler/Dodge	27, 31, 32, 33, 35, 37, 38, 39
Cummins	42-46
Ford	48, 49, 52, 54, 56, 58, 60, 65
Ford Diesel	67, 68, 69
Ford/Lotus	83, 84
Honda/Acura	88, 89, 91-95
Mazda	106, 107
Mitsubishi	110, 112, 113
Nissan	115-122, 124-126
Oldsmobile	68
Pontiac	72
Subaru	132, 133, 135, 136, 138, 139, 140, 141
Toyota	147-149, 151, 152, 154

SEG

Spring Energized Gasket

SEG Gaskets utilize an Inconel jacketed ring and spring with an MLS carrier for ring location and fluid sealing. The resilient nature of the seal ensures useful elastic recovery during service. This recovery aids in the ability of the seal to accommodate minor distortions in the clamped joint, making it conducive for elevated temperature and cylinder pressures like that seen in extremely high horsepower, forced induction applications. *Not available in other thicknesses or bore sizes due to seal ring technology.*



SEG Head Gaskets

Make	Pg.
GM LS1/LS2/LS3/LS6	16
GM LSX Race Block	19
GM LT1/LT4 2014+	21
6.2L Hemi V8 2015-Present "Hellcat"	34
6.4L Hemi V8 2011-Present "Apache"	34

COPPER Head Gaskets

Make	Pg.
Buick V6 192-231-252 Stage I & II	7
GM / Chevy 18/23 Degree Small Block	12
GM / Chevy LS	16
GM / Chevy LSX	20
GM / Chevy Big Block Gen-4	22
Chrysler 318-360 LA	30
Chrysler 383-440 Wedge	37
Chrysler Early Hemi 354-392	38
Chrysler 426 Hemi	39
Ford 429-460	65
Austin Sprite Mark I & II	72

Miscellaneous Gaskets & Accessories

Application	Pg.
Molded Rubber Valve Cover Gaskets	3
MLS Exhaust Gaskets	162
Valve Stem Seals	3, 163
2PC Rear Main Seals	4
Rear End Gaskets	2
Carburetor Gaskets	2
Fuel Cell Gasket Kit	4
High Vacuum Crank Seals	4
Turbo Gaskets	3
Timing Cover Sets	4
Damper Rebuild O-rings	4
Cometic Block & Head Cleaner	173
Klotz Lubricants	173
Transmission Gaskets	2
Karting Gaskets	165
UTV Gaskets	168



AMC

4.0L Inline 6 242ci 1987-2006: 87-01 Cherokee, 93-04 Grand Cherokee, 87-90 Wagoneer, 87-92 Comanche, 91-06 Wrangler

Head Gaskets

MLS Head Gaskets

Bore	Thickness	Pkg Qty	Part #	List Price
3.950"	.050"	1	C5987-050	\$124.76
4.000"	.050"	1	C5988-050	\$124.76
4.060"	.050"	1	C5989-050	\$124.76

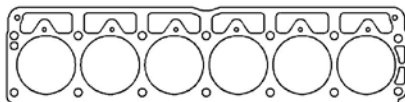

Additional thicknesses available see page 5

Individual Gaskets

Timing Cover Set

Application	Part #	List Price
3.8/4.0/4.2L I6 1965-2006	C5047	\$17.66

290-401ci V8

Head Gaskets

MLS Head Gaskets

Fits: 290 1966-69, 304 1970-78, 343 1967-69, 360 1970-91

Bore	Thickness	Pkg Qty	Part #	List Price
3.810"	.040"	1	C5669-040	\$102.16
4.140"	.040"	1	C5674-040	\$102.16

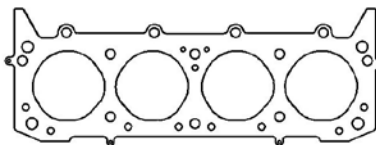

Additional thicknesses available see page 5

MLS Head Gaskets

Fits: 390 1970 & 401 1972-74

Bore	Thickness	Pkg Qty	Part #	List Price
4.250"	.040"	1	C5937-040	\$102.16
4.380"	.040"	1	C5938-040	\$102.16

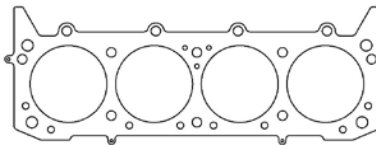

MLS Head Gaskets

Fits: INDY 401 Aluminum Heads

Bore	Thickness	Pkg Qty	Part #	List Price
4.380"	.040"	1	C5409-040	\$102.16
4.380"	.080"	1	C5409-080	\$141.78

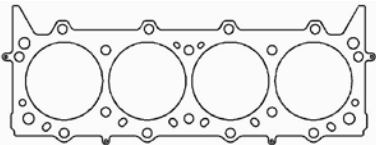

Individual Gaskets

Exhaust Gasket Set

Application	Part #	List Price
304-401ci w/Dogleg Ports	C5161-064	\$26.98
304-401ci w/Rectangle Ports	C5101-064	\$26.98

Intake Gasket Set

Application	Part #	List Price
290-401 V8 1970-91 1.13" x 2.22"	C15002-060	\$30.59
390/401 Indy Head 1.20" x 2.30"	C15003-060	\$30.59

Valve Cover Gasket (sold individually)

Application	Part #	List Price
390/401ci V8 Indy Head	C5115-188	\$17.25

Timing Cover Set

Application	Part #	List Price
290-401ci V8 1966-88	C5046	\$17.66

BUICK

196, 231, 252ci V6 Stock, Stage I, and Stage II

Head Gaskets

MLS Head Gaskets - Stock

Bore	Thickness	Pkg Qty	Part #	List Price
3.860"	.040"	1	C15577-040	\$93.07



Additional thicknesses available see page 5

See page 7 for additional gaskets



BUICK

196, 231, 252ci V6 Stock, Stage I, and Stage II

Head Gaskets

MLS Head Gaskets - Stage I, Stagell

Bore	Thickness	Pkg Qty	Part #	List Price
3.860"	.040"	1	C5691-040	\$93.07
4.020"	.040"	1	C5692-040	\$93.07
4.090"	.040"	1	C5693-040	\$93.07

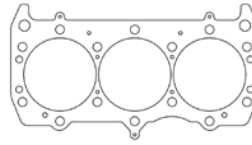

Additional thicknesses available see page 5

Copper Head Gaskets

Bore	Thickness	Pkg Qty	Part #	List Price
3.860"	.043"	1	C15407-043	\$103.99

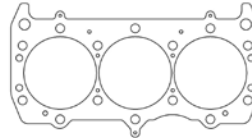

Individual Gaskets

NEW!

Exhaust Gasket Set

Application	Part #	List Price
Stock & Stage I Ports AM Material	C5696-064	\$30.08
Stock & Stage I Ports MLS	C15641-030	\$43.67
Stage II Ports AM Material	C5791-064	\$30.08

Valve Cover Gasket (sold individually)

Application	Part #	List Price
Iron & Aluminum Heads	C5697-188	\$17.25

Intake Gasket Set

Application	Part #	List Price
Stock & Stage I Ports	C5694-060	\$26.26
Stage II Ports	C5792-060	\$30.08

Timing Cover Set

Application	Part #	List Price
66-87 V6/Small V8 w/Rope Seal	C5048	\$23.56
66-87 V6/Small V8 w/Radial Seal	C5049	\$17.66

Oil Pan Gasket

Application	Part #	List Price
20 Bolt	C5700-094	\$24.23

Rear Main Seal

Application	Part #	List Price
2 Piece w/Side Rails	C5707	\$19.00

3800 Series II/III V6 L26, L32, L36, L67 1995-2009

Head Gaskets

MLS Head Gasket - Left Side

Bore	Thickness	Pkg Qty	Part #	List Price
3.840"	.066"	1	C5720-066	\$141.78

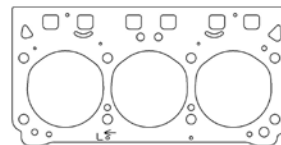

Additional thicknesses available see page 5

MLS Head Gasket - Right Side

Bore	Thickness	Pkg Qty	Part #	List Price
3.840"	.066"	1	C5721-066	\$141.78

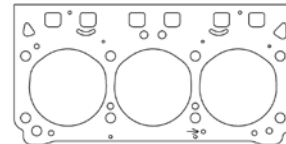

400, 430 & 455 V8 - All Years

Head Gaskets

MLS Head Gaskets

Bore	Thickness	Pkg Qty	Part #	List Price
4.312"	.040"	1	C5753-040	\$104.70
4.385"	.040"	1	C5754-040	\$104.70
4.400"	.040"	1	C5755-040	\$104.70



Additional thicknesses available see page 5

See page 8 for additional gaskets



BUICK

400, 430 & 455 V8 - All Years

Individual Gaskets

Exhaust Gasket Set

Application	Part #	List Price
All Years	C5776-064	\$31.88

Intake Gasket Set

Application	Part #	List Price
1967-71 1.172" x 2.453" Port.....	C5143-060	\$29.26
1972-76 1.156" x 2.420" Port.....	C5775-060	\$30.69

Oil Pan Gasket

Application	Part #	List Price
1967-76 4pc Set	C5145	\$38.34

Valve Cover Gasket (sold individually)

Application	Part #	List Price
Buick 400/430/455 1967-76 .188" Molded Rubber. C15579		\$30.85
Buick 400/430/455 1967-76 V8 .094" KF	C5774-094 ..	\$12.21

Water Pump Gasket

Application	Part #	List Price
1967-76 Water Pump Gasket	C5144-031	\$11.19
1967-76 Water Outlet Gasket.....	C15004-031	\$2.03

Timing Cover Set

Application	Part #	List Price
67-76 400, 430, 455 V8	C5050	\$17.66

Gasket Kits



To purchase a complete gasket kit order both top end and bottom end gasket kit

TOP END GASKET KIT



Application	Part #	List Price
Big Block 455ci 1970-76 4.385" Bore	PRO1011T	\$203.52

BOTTOM END GASKET KIT



Application	Part #	List Price
Big Block 455ci 1970-76.....	PRO1011B	\$34.37

CADILLAC

Northstar 4.6L 32v V8 L37, LD8 FWD 1993-2011

Head Gaskets

MLS Head Gasket - Right Side

Bore	Thickness	Pkg Qty	Part #	List Price
3.700"066"	1.....	C5716-066	\$153.23

MLS Head Gasket - Left Side

Bore	Thickness	Pkg Qty	Part #	List Price
3.700"066"	1.....	C5717-066	\$153.23

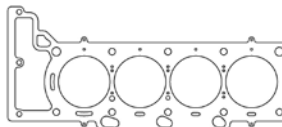
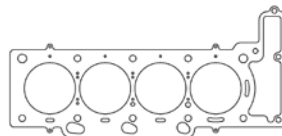

Additional thicknesses available see page 5



CADILLAC

LTG 2.0L DOHC 2013-Present

NEW!

Head Gaskets

MLX Head Gaskets - LTG 2.0L DOHC

Bore	Thickness	Pkg Qty	Part #	List Price
87mm	.028"	1	C4964-028	\$141.78
87mm	.040	1	C4964-040	\$141.78

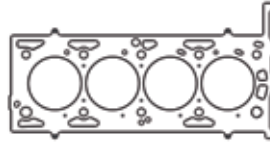

Additional thicknesses available
see page 5

CHEVROLET / GM

ECOTEC 4 Cylinder

Head Gaskets

MLX Head Gasket - L3A/LE2/LFV/LV7/LYX 1.4L/1.5L 17-20

Bore	Thickness	Pkg Qty	Part #	List Price
75mm	.044"	1	C15565-044	\$116.19

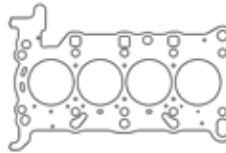

Additional thicknesses available
see page 5

MLS Head Gasket - LSJ 2.0L

Bore	Thickness	Pkg Qty	Part #	List Price
87mm	.027"	1	C5921-027	\$102.16

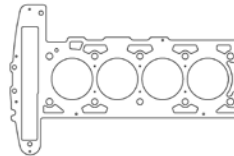

MLX Head Gasket - LSJ 2.0L

Bore	Thickness	Pkg Qty	Part #	List Price
87mm	.040"	1	C5032-040	\$141.78

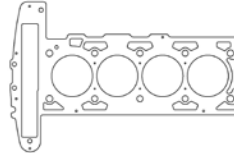

MLX Head Gasket - LNF 2.0L 08-10

Bore	Thickness	Pkg Qty	Part #	List Price
88mm	.032"	1	C15256-032	\$141.78

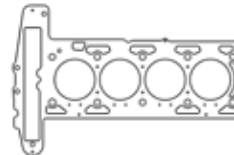

MLX Head Gasket - LTG 2.0L DOHC

Bore	Thickness	Pkg Qty	Part #	List Price
87mm	.028"	1	C4964-028	\$141.78

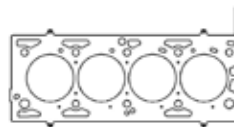

MLS Head Gaskets - L61/L42 2.2L DOHC

Bore	Thickness	Pkg Qty	Part #	List Price
87mm	.040"	1	C5768-040	\$102.16
89mm	.040"	1	C5804-040	\$102.16

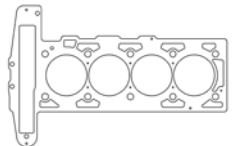

MLX Head Gaskets - LAT/LE5/LE9 Gen-2 ECOTEC 2.4L

Bore	Thickness	Pkg Qty	Part #	List Price
89.6mm	.036"	1	C15422-036	\$141.78

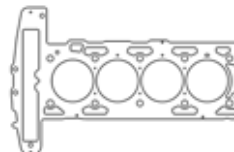

Individual Gaskets

MLS Exhaust Gasket - L42/L61/LAT/LE5 Gen-1/2 ECOTEC 2.2/2.4L

Application	Part #	List Price
2000-2009 2.2/2.4L	C4150-030	\$24.69



CHEVROLET / GM

2.2L 134ci "L43/LN2": Cavalier/Sunfire FWD 1998-02, S-10/Sonoma RWD 1998-03

Head Gaskets

MLS Head Gaskets

Bore	Thickness	Pkg Qty	Part #	List Price
90mm	.030"	1	C5914-030	\$102.16
93mm	.030"	1	C5915-030	\$102.16

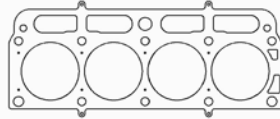

Additional thicknesses available
see page 5

2.4L 146ci "LD9" Twin Cam 1996-01

Head Gaskets

MLS Head Gasket - 1996-99 w/EGR

Bore	Thickness	Pkg Qty	Part #	List Price
3.595"	.030"	1	C5298-030	\$102.16

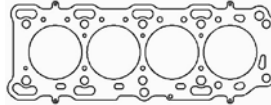

Additional thicknesses available
see page 5

MLS Head Gaskets - 1999-01 w/o EGR

Bore	Thickness	Pkg Qty	Part #	List Price
3.595"	.030"	1	C5866-030	\$102.16
3.595"	.075"	1	C5866-075	\$141.78

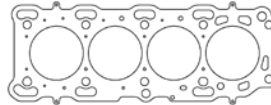

2.5L 153ci 1965-79 / 3.0L VORTEC 3000 (Marine)

Head Gasket

MLS Head Gasket

Bore	Thickness	Pkg Qty	Part #	List Price
4.100"	.045"	1	C5956-045	\$93.07

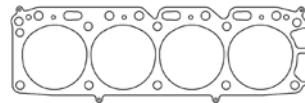

Additional thicknesses available
see page 5

3.1L L82/LG8, 3.4L LA1 Gen-3 60 Degree V6

Head Gaskets

MLS Head Gaskets - 3.1L L82/LG8 1993-05

Bore	Thickness	Pkg Qty	Part #	List Price
91mm	.051"	1	C5220-051	\$100.57

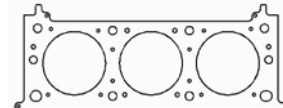

Additional thicknesses available
see page 5

MLS Head Gaskets - 3.4L LA1 1996-05

Bore	Thickness	Pkg Qty	Part #	List Price
95mm	.051"	1	C5266-051	\$100.57

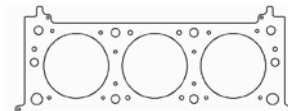

Individual Gaskets

Exhaust Gasket Set

Application	Part #	List Price
1993-05 3.1/3.4L V6	C15005-064	\$20.50

3.5L LZ4/LZE, 3.9L LGD/LZ8/LZ9/LZG High Value V6 2006-2011

MLS Head Gaskets - Left Side

Bore	Thickness	Pkg Qty	Part #	List Price
101mm	.051"	1	C5226-051	\$100.57

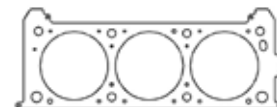

Additional thicknesses available
see page 5

MLS Head Gaskets - Right Side

Bore	Thickness	Pkg Qty	Part #	List Price
101mm	.051"	1	C5227-051	\$100.57

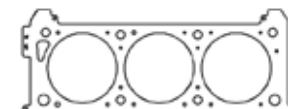



CHEVROLET / GM

3.6L LF3/LF4/LFR/LFX/LFY/LLT/LWR/LY7 High Feature V6 2004-Present

Head Gaskets

MLX Head Gasket - Left Side				
Bore	Thickness	Pkg Qty	Part #	List Price
98mm	.044"	1	C5029-044	\$100.57

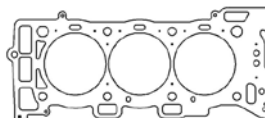

Additional thicknesses available see page 5

MLX Head Gasket - Right Side				
Bore	Thickness	Pkg Qty	Part #	List Price
98mm	.044"	1	C5028-044	\$100.57

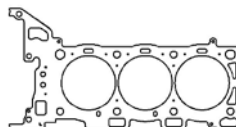

4.3L 262ci 90 Degree V6 1985-2014

Head Gaskets

MLS Head Gaskets				
Bore	Thickness	Pkg Qty	Part #	List Price
4.060"	.040"	1	C5739-040	\$102.16
4.120"	.040"	1	C5740-040	\$102.16
4.155"	.040"	1	C5741-040	\$102.16

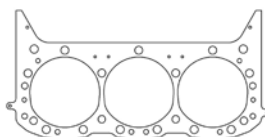

Additional thicknesses available see page 5

Individual Gaskets

Valve Cover Gasket (sold individually)			
Application	Part #	List Price	
4.3L V6 .125" Molded Rubber, Center Bolt...	C15006-125	\$14.00	
4.3L V6 .188" ML Material, Perimeter Bolt...	C15006-188	\$17.25	

Timing Cover Set		
Application	Part #	List Price
1985-95 w/Thick Front OP Seal	C5051	\$17.66

Intake Gasket Set		
Application	Part #	List Price
4.3L V6 .060" Fiber, No EGR Passage	C15007-060	\$30.16

Water Pump Gasket		
Application	Part #	List Price
.018" AFM Material	C5299-018	\$0.73

Exhaust Gasket Set		
Application	Part #	List Price
1985-92 4.3L V6 .064" AM	C15008-064	\$20.50

Oil Pan Gasket		
Application	Part #	List Price
1978-95 4 Piece Set	C5496	\$28.07

Fuel Pump Mounting Gasket		
Application	Part #	List Price
1985-96 4.3L V6 .020" Fiber	C15009-020	\$2.36

Rear Main Seal Kit		
Application	Part #	List Price
1 Piece Design	C5106	\$28.07

Gasket Kits



To purchase a complete gasket kit order both top end and bottom end gasket kit

TOP END GASKET KIT



Application	Part #	List Price
4.3L V6 1985-93 4.120" Bore	PRO1006T	\$177.81

BOTTOM END GASKET KIT



Application	Part #	List Price
4.3L V6 1985-93	PRO1006B	\$57.29



CHEVROLET / GM

194, 230, 250, 292 Inline 6 1962-89

Head Gaskets

MLS Head Gasket

Bore	Thickness	Pkg Qty	Part #	List Price
4.125"	.040"	1	C5699-040	\$182.40

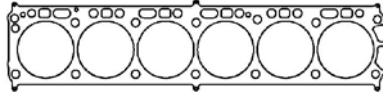

Additional thicknesses available
see page 5

Individual Gaskets

Intake/Exhaust Gasket Set

Application	Part #	List Price
292 I6 Intake .059" CFM	C15010-059	\$56.17

Timing Cover Set

Application	Part #	List Price
4/6 Cyl 151/230/250/292	C5053	\$17.66

4.2L Inline 6 "LL8" Vortec 4200 2002-09

Head Gaskets

MLX Head Gasket

Bore	Thickness	Pkg Qty	Part #	List Price
3.710"	.040"	1	C15374-040	\$195.77

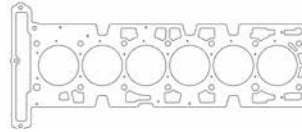

Additional thicknesses available
see page 5

18/23 Degree Small Block V8 262-400ci (*has steam holes)

Head Gaskets

MLS Head Gaskets - Round Bore

Bore	Thickness	Pkg Qty	Part #	List Price
4.060"	.027"	1	C5245-027	\$93.07
4.060"	.030"	1	C5245-030	\$93.07
4.060"	.040"	1	C5245-040	\$93.07
4.060"	.051"	1	C5245-051	\$93.07
4.100"	.040"	1	C5246-040	\$93.07
4.125"	.040"	1	C5247-040*	\$93.07
4.165"	.027"	1	C5248-027*	\$93.07
4.165"	.040"	1	C5248-040*	\$93.07
4.165"	.051"	1	C5248-051*	\$93.07
4.200"	.040"	1	C5249-040*	\$93.07
4.200"	.045"	1	C5249-045*	\$93.07
4.200"	.051"	1	C5249-051*	\$93.07
4.200"	.060"	1	C5249-060*	\$121.99

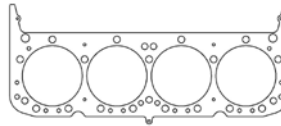

Additional thicknesses available
see page 5

MLS Head Gaskets - Valve Pocketed Bore

Bore	Thickness	Pkg Qty	Part #	List Price
4.060"	.040"	1	C5269-040	\$93.07
4.100"	.040"	1	C5270-040	\$93.07
4.125"	.040"	1	C5271-040*	\$93.07
4.165"	.040"	1	C5272-040*	\$93.07
4.200"	.040"	1	C5273-040*	\$93.07

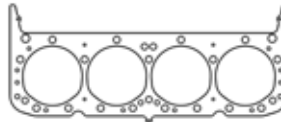

MLX Head Gaskets - Round Bore

Bore	Thickness	Pkg Qty	Part #	List Price
4.165"	.040"	1	C5031-040	\$119.67
4.200"	.040"	1	C15575-040	\$119.67
4.220"	.040"	1	C5786-040*	\$119.67

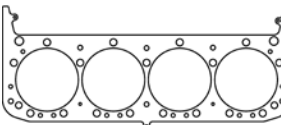

Copper Head Gaskets - Round Bore

Bore	Thickness	Pkg Qty	Part #	List Price
4.165"	.043"	1	C15411-043	\$116.62

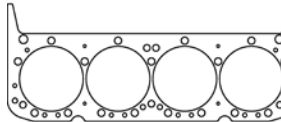

Copper Head Gaskets - No Steam Holes

Bore	Thickness	Pkg Qty	Part #	List Price
4.200"	.043"	1	C15412-043	\$116.62

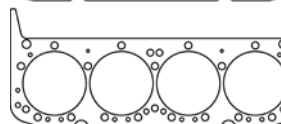



CHEVROLET / GM

18/23 Degree Small Block V8 262-400ci (*has steam holes)

NEW!

Individual Gaskets

Valve Cover Gaskets (sold individually)		
Application	Part #	List Price
18/23° Molded Rubber.....	C5973	\$23.56
Splayed Valve Heads	C5390-094	\$20.50
23* .188" Fiber 1986-02 Center Bolt, Pair	C15206	\$30.59

Intake Gasket Set		
Application	Part #	List Price
18* Heads 1.35" X 2.25" Port	C5541-060	\$30.59
23* Heads 1.24" X 1.98" Port	C5544-060	\$30.59
23* Heads 1.24" x 2.10" Port	C5542-060	\$30.59
23* Heads 1.28" x 2.17" Port.....	C5528-060	\$30.59
305/350 w/TPI 1985-92 Set.....	C15198	\$36.41
End Seal Gaskets.....	C5536-060	\$6.42

Timing Cover Set		
Application	Part #	List Price
1957-74 w/Thin Front OP Seal.....	C5052	\$17.66
1975-95 w/Thick Front OP Seal	C5051	\$17.66

Water Pump Gaskets		
Application	Part #	List Price
Water Pump MTG Gasket	C5299-018	\$0.73
Water Pump Backing Plate Gsk	C15011-032	\$6.29

Thermostat Gasket		
Application	Part #	List Price
.047" Fiber	C5538-047	\$1.18

Oil Pan Gasket Kit		
Application	Part #	List Price
1955-79 LH Dipstick 4pc Kit	C5295-094	\$30.15
1980-85 RH Dipstick 4pc Kit.....	C5294	\$30.15
1955-85 Dual Dipstick 1 pc Molded Rubber....	C15546	\$34.32
1986-97 1 pc Molded Rubber	C5072	\$38.57

Exhaust Gasket Set		
Application	Part #	List Price
18* 1.50" x 1.47" .064" AM.....	C5314-064	\$37.06
23* 1.45" x 1.48" .030" MLS	C5892-030	\$42.68
23* 1.50" Round .030" MLS.....	C5891-030	\$42.68
23* 1.45" x 1.60" .030" MLS	C5894-030	\$43.82
23* 1.625" Round .030" MLS.....	C5893-030	\$43.82
23* 1.480" x 1.45" .030" MLS	C15190-030	\$41.77

Fuel Pump Mounting Gaskets		
Application	Part #	List Price
2 Bolt - .032" AFM.....	C5389-032	\$1.86
4 Bolt - .032" AFM.....	C15012-032	\$1.86

Rear Main Seal Kit		
Application	Part #	List Price
2 Piece SN	C5680	\$25.52
1 Piece SN.....	C5106	\$28.07

Distributor Gasket		
Application	Part #	List Price
.060" Fiber	C5531-060	\$1.35

Gasket Kits



To purchase a complete gasket kit order both top end and bottom end gasket kit

TOP END GASKET KIT

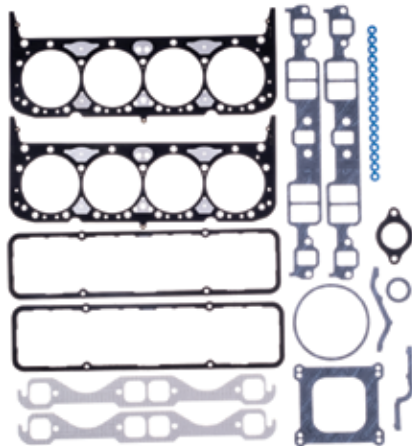

Application	Part #	List Price
350ci (67-85) & 400ci (70-76) 4.165" Bore ...	PRO1003T	\$242.08
350ci TPI (87-92), TBI (86-93) 4.100" Bore..	PRO1004T	\$252.79
Z24 Crate Engine 4.080" Bore	PRO1026T	\$224.94

BOTTOM END GASKET KIT

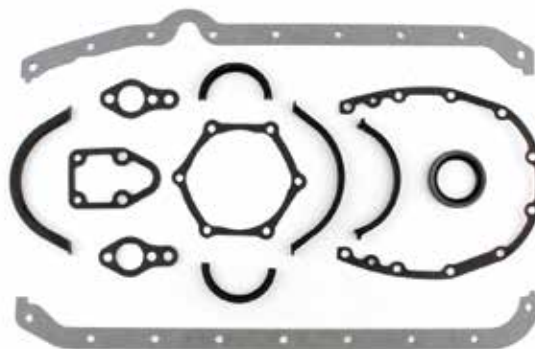

Application	Part #	List Price
350ci (67-79) & 400ci (70-76).....	PRO1003B	\$76.04
350ci (86-93) 1pc Rear Main.....	PRO1004B	\$68.76



CHEVROLET / GM

Small Block V8 - Aftermarket & Race

Head Gaskets

MLS Head Gaskets - Vortec Head

Bore	Thickness	Pkg Qty	Part #	List Price
4.080"	.040"	1	C5474-040	\$93.07
4.165"	.040"	1	C5410-040	\$93.07

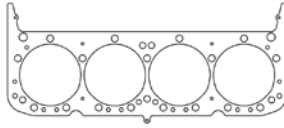

Additional thicknesses available
see page 5

MLS Head Gasket - Edelbrock RPM Heads

Bore	Thickness	Pkg Qty	Part #	List Price
4.135"	.040"	1	C5274-040	\$93.07

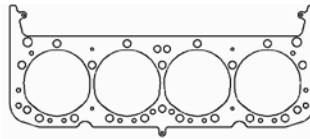

MLS Head Gaskets - Brodix BD2000

Bore	Thickness	Pkg Qty	Part #	List Price
4.030"	.040"	1	C5404-040	\$90.46
4.125"	.040"	1	C5405-040	\$90.46
4.135"	.040"	1	C5406-040	\$90.46
4.160"	.040"	1	C5407-040	\$90.46
4.200"	.040"	1	C5408-040	\$90.46

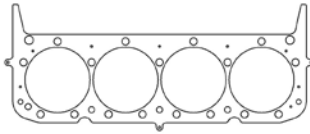

MLS Head Gaskets - Aftermarket Heads - Undersized Water Ports to Allow for Customization

Bore	Thickness	Pkg Qty	Part #	List Price
4.030"	.040"	1	C5399-040	\$90.46
4.125"	.040"	1	C5400-040	\$90.46
4.135"	.040"	1	C5401-040	\$90.46
4.160"	.040"	1	C5402-040	\$90.46
4.200"	.040"	1	C5403-040	\$90.46

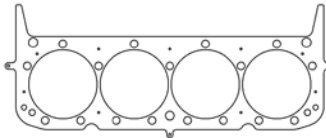

MLX Head Gasket - All Pro Heads

Bore	Thickness	Pkg Qty	Part #	List Price
4.220"	.040"	1	C5551-040	\$119.67

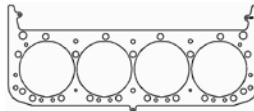

MLS Head Gasket - Dart/Brodix 4.5" Bore Spacing

Bore	Thickness	Pkg Qty	Part #	List Price
4.270"	.036"	1	C5215-036	\$95.80
4.270"	.040"	1	C5215-040	\$95.80
4.270"	.045"	1	C5215-045	\$95.80

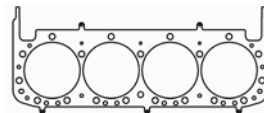

MLX Head Gasket - Dart/Brodix 4.5" Bore Spacing

Bore	Thickness	Pkg Qty	Part #	List Price
4.310"	.040"	1	C15208-040	\$119.67

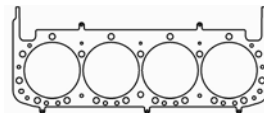

Individual Gaskets

Intake Manifold Gaskets

Application	Part #	List Price
23° Dart Cast Iron	C5528-060	\$30.59
Brodix BD2000	C5421-060	\$26.99
Brodix WP 12S	C5425-059	\$26.99
Brodix WP 247	C5426-059	\$26.99
Brodix WP 262	C5427-059	\$26.99
Brodix GB 2000	C5423-059	\$26.99
Brodix Track 1 & Spec Head	C5414-059	\$26.99
Brodix Street	C5416-059	\$26.99
End Seal Gaskets	C5536-060	\$6.42

Exhaust Manifold Gaskets

Application	Part #	List Price
Brodix GB 2000 - .064" AM	C5422-064	\$22.77
Brodix Track 1 - .064" AM	C5415-064	\$22.77
Brodix Street - .064" AM	C5417-064	\$22.77
Brodix/All Pro 286 (7 Bolt) MLS	C5040-030	\$39.59
Brodix/Dart 13° 4.4/4.5" Spacing	C5039-030	\$39.59

Oil Pan Gasket

Application	Part #	List Price
Dart Iron Eagle/Rocket Block	C5104-094	\$40.93



CHEVROLET / GM

350 & 400 SB2 Race V8

Head Gaskets

MLS Head Gaskets

Bore	Thickness	Pkg Qty	Part #	List Price
4.125"	.040"	1	C5321-040	\$93.07
4.165"	.040"	1	C5323-040	\$93.07
4.190"	.040"	1	C5472-040	\$93.07
4.200"	.040"	1	C5324-040	\$93.07

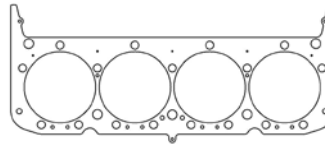

Additional thicknesses available
see page 5

Individual Gaskets

Valve Cover Gasket (sold individually)

Application	Part #	List Price
SB2 - .188" Thickness	C5235-188	\$21.69

Timing Cover Gasket

Application	Part #	List Price
SB2 - .020" RC	C5533-020	\$21.69

Intake Manifold Set

Application	Part #	List Price
SB2 - 2.085" x 1.560" Ports	C5311-031	\$34.48
SB2 - MLS	C5819-040	\$76.52

Water Pump Gasket

Application	Part #	List Price
Water Pump MTG Gasket	C5299-018	\$0.73
Water Pump Backing Plate Gsk	C15011-032	\$6.29

Intake Valley Plate Gaskets

Application	Part #	List Price
Stock Opening - .060" AFM	C5647-060	\$24.64
.970" Holes - .060" AFM	C5308-060	\$24.64
.625"/.750" Holes - .060" AFM	C5307-060	\$24.64

Exhaust Manifold Gaskets

Application	Part #	List Price
1.50" x 1.60" Ports - MLS	C5552-065	\$36.45
1.90" x 1.63" Ports - MLS	C5836-030	\$57.81

Rear Main Seal

Application	Part #	List Price
Dual Lip/High Vacuum	C5379	\$61.01

Oil Pan Gasket

Application	Part #	List Price
SB2 - 4pc Set	C5553-060	\$38.29

Distributor Gasket

Application	Part #	List Price
.060" Fiber	C5531-060	\$1.35

Fuel Pump Mounting Gasket

Application	Part #	List Price
4 Bolt - .032" AFM	C15012-032	\$1.86

R07.2 Race V8

Head Gasket

MLX Head Gasket

Bore	Thickness	Pkg Qty	Part #	List Price
4.220"	.040"	1	C5577-040	\$120.47

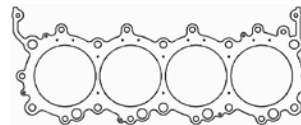

Additional thicknesses available
see page 5

Individual Gaskets

Rubber Seal/O-Ring Kit

Application	Part #	List Price
R07.2	C5979	\$245.55

Valve Cover Gasket (sold individually)

Application	Part #	List Price
Nitrile Formed Rubber O-Ring	C15013	\$19.66



CHEVROLET / GM

LT1 / LT4 350ci 1992-96

Head Gaskets

MLS Head Gaskets

Bore	Thickness	Pkg Qty	Part #	List Price
4.040"	.040"	1	C5645-040	\$93.07
4.100"	.040"	1	C5646-040	\$93.07

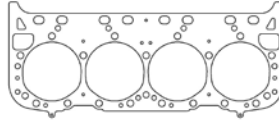

Additional thicknesses available
see page 5

Individual Gaskets

Valve Cover Gasket (sold individually)

Application	Part #	List Price
.094" Thickness	C15014-094	\$12.82

Exhaust Manifold Gaskets

Application	Part #	List Price
1.52" x 1.51" Ports, MLS	C5895-030	\$44.94

Intake Manifold Set

Application	Part #	List Price
LT1/LT4 - 2.085" x 1.560" Ports	C15015-060	\$35.63

Throttle Body Gasket Gasket

Application	Part #	List Price
1992-97 LT1/LT4	C15016-060	\$5.96

Oil Pan Gasket Set

Application	Part #	List Price
1992-97 1 pc Molded Rubber	C5072	\$38.57

Rear Main Seal Kit

Application	Part #	List Price
1 Piece Viton	C5106	\$28.07

Exhaust Pipe Gaskets

Application	Part #	List Price
Header Collector Gasket	C15017-064	\$4.67
Y-Pipe Gasket	C15018-064	\$7.03

Timing Cover Sets

Application	Part #	List Price
1992-94	C5054	\$17.66
1994-97	C5055	\$23.56

Water Pump Gasket

Application	Part #	List Price
Water Pump Mounting Gasket	C15019-031	\$5.73

LS1 / LS6 5.7L, LS2 6.0L, & LS3 6.2L

Head Gaskets

MLS Head Gaskets

Bore	Thickness	Pkg Qty	Part #	List Price
3.810"	.051"	1	C15361-051	\$93.07
3.910"	.040"	1	C5475-040	\$93.07
3.910"	.051"	1	C5475-051	\$93.07
4.060"	.040"	1	C5751-040	\$93.07
4.060"	.051"	1	C5751-051	\$93.07
4.100"	.040"	1	C5489-040	\$93.07
4.100"	.051"	1	C5489-051	\$93.07
4.130"	.051"	1	C5317-051	\$93.07
4.160"	.051"	1	C5318-051	\$93.07
4.190"	.051"	1	C5319-051	\$93.07

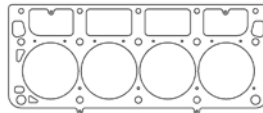

Additional thicknesses available
see page 5

MLX Head Gaskets

Bore	Thickness	Pkg Qty	Part #	List Price
4.040"	.051"	1	C5505-051	\$119.67
4.150"	.040"	1	C5014-040	\$119.67
4.150"	.052"	1	C5014-052	\$119.67

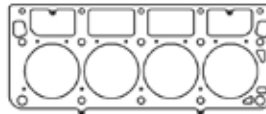

SEG Head Gaskets, With SEG Rings

Bore	Thickness	Pkg Qty	Part #	List Price
4.150"	.051"	1	C15540-051	\$264.61
4.200"	.051"	1	C15542-051	\$264.61

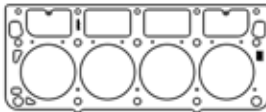

Copper Head Gaskets

Bore	Thickness	Pkg Qty	Part #	List Price
4.100"	.050"	1	C15408-050	\$116.62

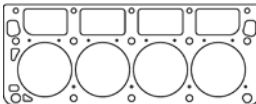

Individual Gaskets

Valve Cover Gasket (sold individually)

Application	Part #	List Price
99-14 LS V8 - Center Bolt	C5170	\$14.00
Valve Cover Grommet Set	C15030	\$11.34

Exhaust Manifold Gaskets

Application	Part #	List Price
97-13 LS V8 - Round Port	C5818-030	\$37.62



CHEVROLET / GM

LS1 / LS6 5.7L, LS2 6.0L, & LS3 6.2L

Individual Gaskets

Intake Manifold Gaskets

Application	Part #	List Price
99-05 5.7/6.0L Car Intake	C5165	\$39.96
99-05 5.3/6.0L Truck Intake	C5166	\$71.47
LS3/L92 Carb Intake Gaskets	C15022-060	\$28.23
08-13 LS3 6.2L Car Intake	C5037	\$39.00
07-13 6.0/6.2L Truck Intake	C15024	\$76.69
Gen III LS1/LS6 Valley Gasket	C15026	\$23.71
Gen IV LS w/D.O.D. Valley Gasket	C15023	\$65.70
Gen IV LS w/o D.O.D. Valley Gasket	C15025	\$32.60

Fuel Injector O-Ring Set

Application	Part #	List Price
Upper and Lower O-Rings	C15027	\$26.14

Exhaust Pipe Gaskets

Application	Part #	List Price
Graphite Exhaust Pipe	C15028	\$9.31
Metal Ring Exhaust Pipe	C15029	\$8.01

Cooling/Water Pump Gaskets

Application	Part #	List Price
99-13 LS V8 (pair) Molded	C5174	\$10.29
99-13 LS V8 (pair) .031" Fiber	C15032-031	\$5.57
99-13 Water Pump Backing O-ring	C15033	\$1.84
97-13 Coolant Bypass Seals	C15034	\$5.95

Knock Sensor Grommet Kit

Application	Part #	List Price
1999-2013 - 2 Pack	C15035	\$6.83

Throttle Body Gaskets

Application	Part #	List Price
97-05 5.7L	C5168	\$12.82
99-05 4.8/5.3/6.0L	C5169	\$12.82
2005 5.3/6.0L SUV	C15020	\$8.98
06-13 4.8/5.3/6.0/6.2L	C15021	\$14.62

Rear Main Seal Kit

Application	Part #	List Price
1997-13 LS V8	C5172	\$60.74

Oil Pan Gasket Set

Application	Part #	List Price
97-13 LS V8 (not Vette)	C5173	\$34.31

Valve Stem Seals

Application	Part #	List Price
97-01 LS V8	3516PB-16	\$27.62
02-13 LS V8 - Hat Style	3256V-16	\$25.31

Timing Cover Set

Application	Part #	List Price
1997-Up LS V8	C5056	\$41.23

Cam Plate Gasket

Application	Part #	List Price
with Recessed Bolts	C15031	\$28.10

Thermostat Seal

Application	Part #	List Price
2004-13 Gen IV	C15036	\$6.54

Gasket Kits



To purchase a complete gasket kit order both top end and bottom end gasket kit

TOP END GASKET KIT

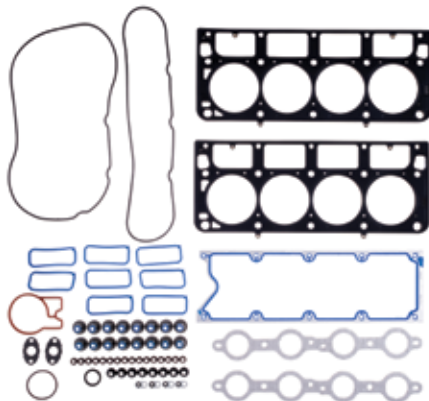

Application	Part #	List Price
1997-05 LS1/LS6 5.7L (Car Only)	PRO1007T	\$242.08
LS3/L92 6.2L Carbureted 4.060" Bore	PRO1035T	\$190.26
1999-01 6.0L (Truck Only) 4.100" Bore	PRO1008T	\$214.23
2001-10 4.8/5.3L Truck/Van/SUV 3.840" Bore	PRO1040T	\$359.91
2001-07 6.0L Truck/Van/SUV 4.060" Bore	PRO1041T	\$263.50
2005-07 6.0L Truck/Van/SUV 4.100" Bore	PRO1037T	\$306.35
2007-10 6.0/6.2L Truck/Van/SUV 4.100" Bore	PRO1036T	\$342.77
2009-11 LS3 6.2L (Car Only)	PRO1043T	\$295.64

BOTTOM END GASKET KIT



Application	Part #	List Price
4.8/5.3/5.7/6.0/6.2L LS V8	PRO1040B	\$167.34
with flat mount Cam Plate Bolts		
4.8/5.3/5.7/6.0/6.2L LS V8	PRO1036B	\$218.30
with recessed Cam Plate Bolts		



CHEVROLET / GM

LS7 7.0L V8

Head Gaskets

MLS Head Gasket

Bore	Thickness	Pkg Qty	Part #	List Price
4.150"	.051"	1	C5889-051	\$102.16

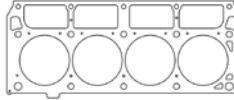

Additional thicknesses available
see page 5

MLX Head Gasket

Bore	Thickness	Pkg Qty	Part #	List Price
4.150"	.052"	1	C5030-052	\$119.67

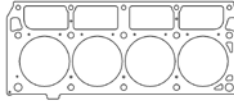

Individual Gaskets

Valve Cover Gasket (sold individually)

Application	Part #	List Price
99-13 LS V8 - Center Bolt	C5170	\$14.00
Valve Cover Grommet Set	C15030	\$11.34

Intake Manifold Gaskets

Application	Part #	List Price
LS7 2006-13 w/Carb Intake	C5167-060	\$28.23
Gen IV LS w/o D.O.D. Valley Gasket	C15025	\$32.60

Exhaust Manifold Gaskets

Application	Part #	List Price
2006-13 D-Port - MLS	C5073-030	\$37.62

Valve Stem Seals

Application	Part #	List Price
05-13 LS7 V8 - Hat Style	3256V-16	\$25.31

Fuel Injector O-Ring Set

Application	Part #	List Price
Upper and Lower O-Rings	C15027	\$26.14

Timing Cover Set

Application	Part #	List Price
1997-Up LS V8	C5056	\$41.23

Cooling/Water Pump Gaskets

Application	Part #	List Price
99-13 LS V8 (pair) Molded	C5174	\$10.29
99-13 LS V8 (pair) .031" Fiber	C15032-031	\$5.57
99-13 Water Pump Backing O-ring	C15033	\$1.84
97-13 Coolant Bypass Seals	C15034	\$5.95

Rear Main Seal Kit

Application	Part #	List Price
1997-13 LS V8	C5172	\$60.74

LS9/LSA 6.2L 2009-2013: 09-13 Corvette ZR1, 09-15 Cadillac CTS-V, 12-15 Camaro ZL1

Head Gaskets

MLX Head Gasket - Right Side

Bore	Thickness	Pkg Qty	Part #	List Price
4.100"	.051"	1	C5985-051	\$119.67

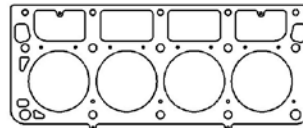

Additional thicknesses available
see page 5

MLX Head Gasket - Left Side

Bore	Thickness	Pkg Qty	Part #	List Price
4.100"	.051"	1	C5986-051	\$119.67

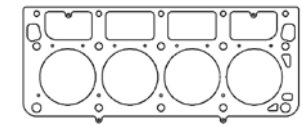

Individual Gaskets

Valve Cover Gasket (sold individually)

Application	Part #	List Price
99-13 LS V8 - Center Bolt	C5170	\$14.00
Valve Cover Grommet Set	C15030	\$11.34

Valve Stem Seals

Application	Part #	List Price
09-13 LS V8 - Hat Style	3256V-16	\$25.51

Exhaust Manifold Gaskets

Application	Part #	List Price
09-13 LS V8 - Round Port	C5818-030	\$37.62

Oil Pan Gasket Set

Application	Part #	List Price
97-13 LS V8 (Pan to Block)	C5173	\$34.31

Intake Manifold Gaskets

Application	Part #	List Price
Gen IV LS w/o D.O.D. Valley Gasket	C15025	\$32.60

Timing Cover Set

Application	Part #	List Price
1997-Up LS V8	C5056	\$41.23

See page 19 for additional gaskets



CHEVROLET / GM

LS9/LSA 6.2L 2009-2013: 09-13 Corvette ZR1, 09-15 Cadillac CTS-V, 12-15 Camaro ZL1

Individual Gaskets

Cooling/Water Pump Gaskets		
Application	Part #	List Price
99-13 LS V8 (pair) Molded	C5174	\$10.29
99-13 LS V8 (pair) .031" Fiber.....	C15032-031	\$5.57
99-13 Water Pump Backing O-ring.....	C15033	\$1.84
97-13 Coolant Bypass Seals	C15034	\$5.95

Rear Main Seal Kit		
Application	Part #	List Price
1997-13 LS V8.....	C5172	\$60.74

GM/DART LS NEXT BLOCK

Head Gaskets

MLX Head Gasket - Right Side				
Bore	Thickness	Pkg Qty	Part #	List Price
4.200"044"	1	C15362-044	\$119.67
4.200"052"	1	C15362-052	\$119.67
4.200"060"	1	C15362-060	\$119.67

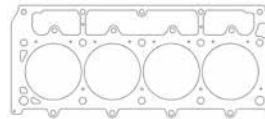

Additional thicknesses available
see page 5

1/2" & 3/8" Stud Hole Combination

MLX Head Gasket - Left Side				
Bore	Thickness	Pkg Qty	Part #	List Price
4.200"044"	1	C15363-044	\$119.67
4.200"052"	1	C15363-052	\$119.67
4.200"060"	1	C15363-060	\$119.67

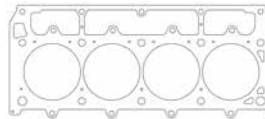

LSX RACE BLOCK

Head Gaskets

MLS Head Gaskets - Right Side				
Bore	Thickness	Pkg Qty	Part #	List Price
4.060"056"	1	C15527-056	\$129.74
4.125"051"	1	C5933-051	\$93.07
4.185"051"	1	C5935-051	\$93.07

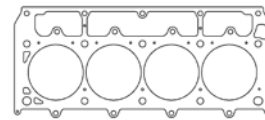

Additional thicknesses available
see page 5

MLS Head Gaskets - Left Side				
Bore	Thickness	Pkg Qty	Part #	List Price
4.060"056"	1	C15526-056	\$129.74
4.125"051"	1	C5934-051	\$93.07
4.185"051"	1	C5936-051	\$93.07

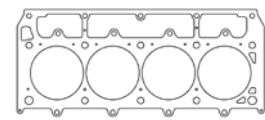

MLX Head Gaskets - Right Side				
Bore	Thickness	Pkg Qty	Part #	List Price
4.100"040"	1	C5075-040	\$119.67
4.165"040"	1	C5702-040	\$119.67
4.200"040"	1	C5077-040	\$119.67

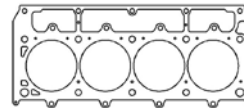

MLX Head Gaskets - Left Side				
Bore	Thickness	Pkg Qty	Part #	List Price
4.100"040"	1	C5076-040	\$119.67
4.165"040"	1	C5703-040	\$119.67
4.200"040"	1	C5078-040	\$119.67

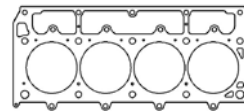

SEG Head Gaskets - Right Side, With SEG Rings, 6 Bolt Kit				
Bore	Thickness	Pkg Qty	Part #	List Price
4.150"051"	1	C15531-051	\$264.61
4.200"051"	1	C15537-051	\$264.61

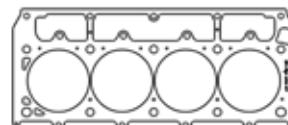

SEG Head Gaskets - Left Side, With SEG Rings, 6 Bolt Kit				
Bore	Thickness	Pkg Qty	Part #	List Price
4.150"051"	1	C15532-051	\$264.61
4.200"051"	1	C15538-051	\$264.61

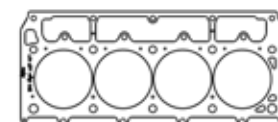

See page 20 for additional gaskets



CHEVROLET / GM

LSX RACE BLOCK

Head Gaskets

Copper Head Gaskets - Left Side

Bore	Thickness	Pkg Qty	Part #	List Price
4.100"	.043"	1	C15409-043	\$116.62

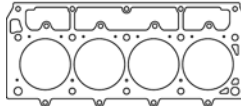

Copper Head Gaskets - Right Side

Bore	Thickness	Pkg Qty	Part #	List Price
4.100"	.043"	1	C15410-043	\$116.62

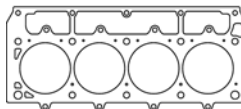

Individual Gaskets

Valve Cover Gasket (sold individually)

Application	Part #	List Price
99-13 LS V8 - Center Bolt	C5170	\$14.00
Valve Cover Grommet Set	C15030	\$11.34

Exhaust Manifold Gaskets

Application	Part #	List Price
2006-13 D-Port - MLS	C5073-030	\$37.62
LSX-DR .064" AM	C15038-064	\$32.95

Intake Manifold Gaskets

Application	Part #	List Price
LS7 2006-13 w/Carb Intake	C5167-060	\$28.23
LSX-DR Head - Lrg Port	C15037-060	\$30.71
Gen IV LS w/o D.O.D. Valley Gasket	C15025	\$32.60

Valve Stem Seals

Application	Part #	List Price
09-13 LS V8 - Hat Style	3256V-16	\$25.31

Oil Pan Gasket Set

Application	Part #	List Price
97-13 LS V8 (Pan to Block)	C5173	\$34.31

Cooling/Water Pump Gaskets

Application	Part #	List Price
99-13 LS V8 (pair) Molded	C5174	\$10.29
99-13 LS V8 (pair) .031" Fiber	C15032-031	\$5.57
99-13 Water Pump Backing O-ring	C15033	\$1.84
97-13 Coolant Bypass Seals	C15034	\$5.95

Timing Cover Set

Application	Part #	List Price
1997-Up LS V8	C5056	\$41.23

Gasket Kits



To purchase a complete gasket kit order both top end and bottom end gasket kit

TOP END GASKET KIT

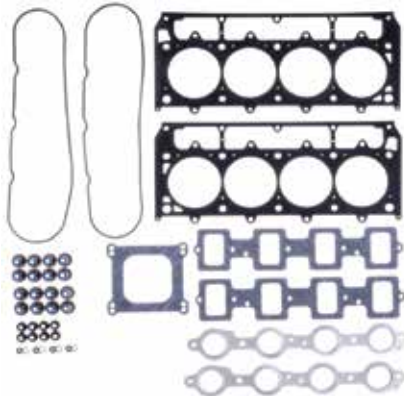

Application	Part #	List Price
LSX w/LS7 Carb Intake 4.125" Bore	PRO1025T	\$182.09

BOTTOM END GASKET KIT



Application	Part #	List Price
LSX V8	PRO1025B	\$143.26

LS1 / LS6 5.7L, LS2 6.0L, & LS3 6.2L w/Darton M.I.D. Sleeves

Head Gaskets

MLS Head Gasket

Bore	Thickness	Pkg Qty	Part #	List Price
3.910"	.040"	1	C5788-040	\$102.16
4.125"	.040"	1	C5789-040	\$102.16
4.165"	.040"	1	C5790-040	\$102.16

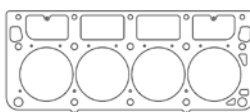

Additional thicknesses available
see page 5



CHEVROLET / GM

L83 / 5.3L EcoTec3

Head Gaskets

MLS Head Gasket

Bore	Thickness	Pkg Qty	Part #	List Price
3.875"	0.058"	1	C15426-058	\$116.19

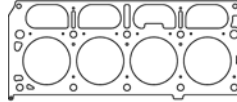

Individual Gaskets

Valve Cover Set

Application	Part #	List Price
2014+ L83 5.3L Valve Cover Set	C15438	\$29.73

LT1 / LT4 6.2L V8 2014+UP

Head Gasket

MLX Head Gasket

Bore	Thickness	Pkg Qty	Part #	List Price
4.100"	.051"	1	C5038-051	\$119.67
4.150"	.051"	1	C15203-051	\$119.67
4.200"	.051"	1	C15202-051	\$119.67

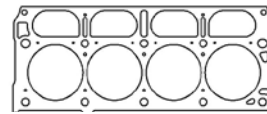

Additional thicknesses available see page 5

SEG Head Gaskets, With SEG Rings

Bore	Thickness	Pkg Qty	Part #	List Price
4.150"	.051"	1	C15597-051	\$264.61
4.200"	.051"	1	C15598-051	\$264.61

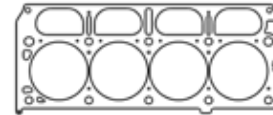

Individual Gaskets

Exhaust Manifold Gasket

Application	Part #	List Price
2014+ 1.920" Port - .021" MLS	C5020-021	\$52.10

Valley Pan Gasket

Application	Part #	List Price
2014+ LT1/LT4 Valley Pan	C15437	\$15.52

Valve Cover Set

Application	Part #	List Price
2014+ LT1/LT4 Valve Cover Set	C15438	\$29.73

Intake Manifold Gaskets

Application	Part #	List Price
2014+ LT1 Set of 8	C15599	\$28.07

348ci 1958-61 / 409ci 1961-65 "W" V8

Head Gaskets

MLS Head Gaskets

Bore	Thickness	Pkg Qty	Part #	List Price
4.200"	.040"	1	C5255-040	\$102.16
4.375"	.040"	1	C5256-040	\$102.16
4.437"	.040"	1	C5219-040	\$102.16

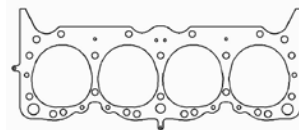

Additional thicknesses available see page 5

Individual Gaskets

Intake Manifold Gasket

Application	Part #	List Price
409ci V8 - .059" CFM	C15039-059	\$34.52
348-409ci V8 - .060" FC, Small Port	C15600-060	\$25.67

Exhaust Manifold Gasket

Application	Part #	List Price
409ci V8 - .064" AM	C15040-064	\$34.52



CHEVROLET / GM

Big Block V8 - Gen4 1965-90 396,402,427,454ci

Head Gaskets

MLS Head Gaskets

Bore	Thickness	Pkg Qty	Part #	List Price
4.320"	.040"	1	C5816-040	\$104.70
4.375"	.040"	1	C5329-040	\$104.70
4.375"	.051"	1	C5329-051	\$104.70
4.540"	.040"	1	C5330-040	\$104.70
4.540"	.051"	1	C5330-051	\$104.70
4.630"	.040"	1	C5331-040	\$104.70
4.630"	.045"	1	C5331-045	\$104.70
4.630"	.051"	1	C5331-051	\$104.70
4.630"	.060"	1	C5331-060	\$142.28

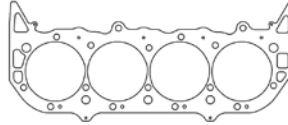

Additional thicknesses available
see page 5

MLX Head Gaskets

Bore	Thickness	Pkg Qty	Part #	List Price
4.560"	.040"	1	C15561-040	\$142.28

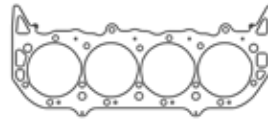

Copper Head Gaskets

Bore	Thickness	Pkg Qty	Part #	List Price
4.320"	.043"	1	C15413-043	\$132.13
4.530"	.043"	1	C15414-043	\$132.13
4.630"	.043"	1	C15415-043	\$132.13

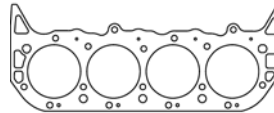

Individual Gaskets

Valve Cover Gasket (sold individually)

Application	Part #	List Price
Molded Rubber .188"	C5975	\$23.56

Intake Manifold Gaskets

Application	Part #	List Price
Rect Port 1.75" x 2.50" - .060" KF	C5649-060	\$30.59
Oval Port 1.82" x 2.05" - .060" KF	C15041-060	\$30.59

Timing Cover Sets

Application	Part #	List Price
1965-95 BBC V8	C5057	\$19.75

Rear Main Seal Kit

Application	Part #	List Price
2pc 1965-90 - Silicone	C5086	\$19.66
2pc 1965-90 - SN	C5682	\$30.59

Exhaust Manifold Gaskets

Application	Part #	List Price
1.85" x 1.90" Sq Port - MLS	C5897-030	\$46.05
1.920" Round Port - MLS	C5896-030	\$46.05
2.000" Round Port - MLS	C5349-030	\$46.05
2.130" Round Port - MLS	C5996-030	\$46.05
2.200" Round Port - MLS	C5350-030	\$46.05
2.250" Round Port - MLS	C5251-030	\$46.05

Oil Pan Gasket Set

Application	Part #	List Price
4pc Kit	C5344	\$30.15
1 pc Molded Rubber	C15550	\$34.32

Cooling/Water Pump Gaskets

Application	Part #	List Price
Water Pump Mounting - Req 2	C5347-039	\$5.51
Water Outlet	C5346-047	\$1.18

Gasket Kits



To purchase a complete gasket kit order both top end and bottom end gasket kit

TOP END GASKET KIT

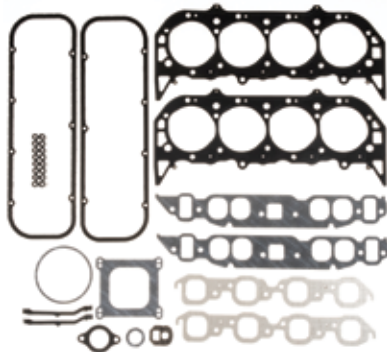

Application	Part #	List Price
454ci 1970-85 4.275" Bore	PRO1005T	\$203.52

BOTTOM END GASKET KIT



Application	Part #	List Price
Big Block Gen4	PRO1005B	\$52.72



CHEVROLET / GM

Big Block V8 - Gen 5/6 1991-00 454, 502ci

Head Gaskets

MLS Head Gaskets

Bore	Thickness	Pkg Qty	Part #	List Price
4.320"	.040"	1	C5817-040	\$104.70
4.375"	.040"	1	C5332-040	\$104.70
4.540"	.040"	1	C5333-040	\$104.70
4.540"	.051"	1	C5333-051	\$104.70
4.630"	.040"	1	C5334-040	\$104.70

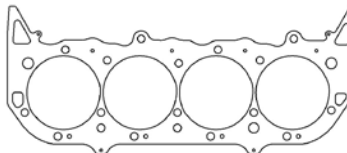

Additional thicknesses available see page 5

Individual Gaskets

Valve Cover Gasket (sold individually)

Application	Part #	List Price
Molded Rubber .188"	C15423	\$13.96

Intake Manifold Gaskets

Application	Part #	List Price
Rect Port 1.75" x 2.50" - .060" KF	C5649-060	\$30.59
Oval Port 1.82" x 2.05" - .060" KF	C15041-060	\$30.59

Exhaust Manifold Gaskets

Application	Part #	List Price
1.85" x 1.90" Sq Port - MLS	C5897-030	\$46.05
1.920" Round Port - MLS	C5896-030	\$46.05
2.000" Round Port - MLS	C5349-030	\$46.05
2.130" Round Port - MLS	C5996-030	\$46.05
2.200" Round Port - MLS	C5350-030	\$46.05
2.250" Round Port - MLS	C5251-030	\$46.05

Timing Cover Sets

Application	Part #	List Price
1990-95 BBC V8	C5057	\$19.75
1996-00 BBC V8	C5058	\$17.66

Cooling/Water Pump Gaskets

Application	Part #	List Price
Water Pump Mounting - Req 2	C5347-039	\$5.51
Water Outlet	C5346-047	\$1.18

Rear Main Seal Kit

Application	Part #	List Price
1pc 1991-00 Gen 5/6 - SN	C5087	\$30.59

Oil Pan Gasket Set

Application	Part #	List Price
1pc Molded Rubber	C15077	\$29.66

Gasket Kits

STREETPRO
by Cometic Gasket

To purchase a complete gasket kit order both top end and bottom end gasket kit

NEW!

TOP END GASKET KIT



Application	Part #	List Price
GM Gen-5/6 454 BB V8 W/Gen4 Heads	PRO1045T	\$207.99
GM Gen-5 L19 454 BB V8	PRO1047T	\$228.79
GM Gen-6 L21/29 454 Big Block V8	PRO1046T	\$239.19

NEW!

BOTTOM END GASKET KIT



Application	Part #	List Price
GM Gen-5 454 L19 BB V8	PRO1045B	\$62.39
GM Gen-6 L21/29/454/502 Big Block V8	PRO1046B	\$60.31



CHEVROLET / GM

Big Block V8 - Aftermarket, Race, & Marine Blocks

Head Gaskets

Additional thicknesses available
see page 5

MLS Head Gaskets - Mercury Gen4/5/6 w/4 Bolts in Lifter Valley

Bore	Thickness	Pkg Qty	Part #	List Price
4.500"	.051"	1	C5634-051	\$95.80
4.530"	.051"	1	C5635-051	\$95.80
4.580"	.051"	1	C5636-051	\$95.80
4.600"	.051"	1	C5637-051	\$95.80

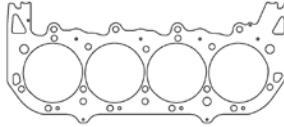

MLS Head Gaskets - Mercury 1050 Gen 4 w/2 Slotted Lifter Valley Bolts

Bore	Thickness	Pkg Qty	Part #	List Price
4.500"	.051"	1	C5638-051	\$95.80
4.530"	.051"	1	C5639-051	\$95.80
4.580"	.051"	1	C5640-051	\$95.80
4.600"	.051"	1	C5641-051	\$95.80

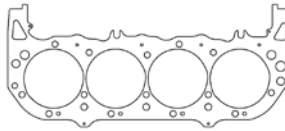

MLS Head Gaskets - Mercury Marine 525/625 Gen VI

Bore	Thickness	Pkg Qty	Part #	List Price
4.470"	.040"	1	C5760-040	\$104.70

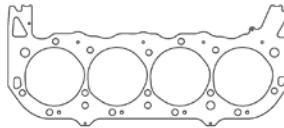

MLS Head Gaskets - Mercury 8.1L 496 - Right Side

Bore	Thickness	Pkg Qty	Part #	List Price
4.280"	.051"	1	C5761-051	\$104.70
4.350"	.051"	1	C5762-051	\$104.70
4.450"	.051"	1	C5763-051	\$104.70

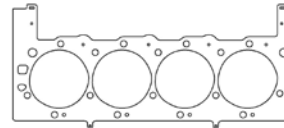

MLS Head Gaskets - Mercury 8.1L 496 - Left Side

Bore	Thickness	Pkg Qty	Part #	List Price
4.280"	.051"	1	C5764-051	\$104.70
4.350"	.051"	1	C5765-051	\$104.70
4.450"	.051"	1	C5766-051	\$104.70

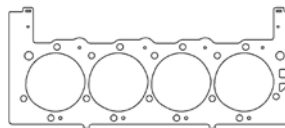

MLS Head Gaskets - Aftermarket Heads - Undersized Water Ports to Allow for Customization

Bore	Thickness	Pkg Qty	Part #	List Price
4.310"	.040"	1	C5432-040	\$95.80
4.570"	.040"	1	C5433-040	\$95.80
4.630"	.040"	1	C5434-040	\$95.80

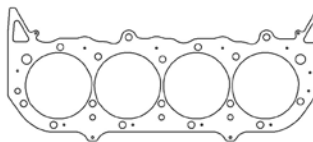

MLS Head Gaskets - ZL1 1969 7.0L 427ci Aluminum Round Bore

Bore	Thickness	Pkg Qty	Part #	List Price
4.250"	.040"	1	C5746-040	\$104.70
4.300"	.040"	1	C5747-040	\$104.70
4.375"	.040"	1	C5759-040	\$104.70

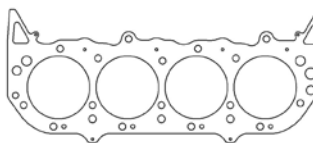

Individual Gaskets

Valve Cover Gasket (sold individually)

Application	Part #	List Price
SR-20 FML .094" Fiber w/ Steel	C15460	\$23.57
Molded Rubber .188"	C5975	\$23.56

Exhaust Manifold Gaskets

Application	Part #	List Price
Brodix Big Brodie -.064" AM	C5429-064	\$22.77
Brodix Big Duke -.064" AM	C5418-064	\$22.77
Mercury 525/625 EFI - MLS	C15364-030	\$48.37
Mercury 1050 - MLS	C5820-051	\$72.87

Intake Manifold Gaskets

Application	Part #	List Price
Brodix SR-20 -.060KF	C15459-060	\$19.09
Brodix Big Brodie Oval -.060" KF	C5430-060	\$26.99
Brodix Big Brodie Rectangle-.060" KF	C5428-060	\$26.99
Brodix Big Duke -.060" KF	C5419-060	\$26.99
Mercury 1050 - MLS	C5821-051	\$76.52

Rear Main Seal Kits

Application	Part #	List Price
2pc 1965-90 - Silicone	C5086	\$19.66
2pc 1965-90 - SN	C5682	\$30.59
1pc 1991-00 Gen 5/6 - SN	C5087	\$30.59



CHEVROLET / GM

Big Block V8 - Aftermarket, Race, & Marine Blocks

Individual Gaskets

Timing Cover Sets

Application	Part #	List Price
1965-95 BBC V8	C5057	\$19.75
1996-00 BBC V8	C5058	\$17.66

Cooling/Water Pump Gaskets

Application	Part #	List Price
Water Pump Mounting - Req 2	C5347-039	\$5.51
Water Outlet	C5346-047	\$1.18

Oil Pan Gasket Set

Application	Part #	List Price
4pc Kit 1965-90	C5344	\$30.15
4pc Kit Bolt Holes@Mains	C5254	\$34.48
1pc Molded Rubber 91-00	C15077	\$29.66

Pro Stock Racing V8

Head Gaskets

MLS Head Gaskets - DRCE-2 4.900" Bore Centers 500ci

Bore	Thickness	Pkg Qty	Part #	List Price
4.675"051"	1	C5449-051	\$135.35
4.700"051"	1	C5450-051	\$135.35
4.780"051"	1	C5451-051	\$135.35

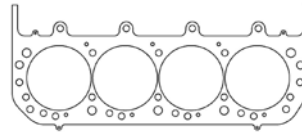

Additional thicknesses available
see page 5

MLS Head Gaskets - DRCE-3 4.900" Bore Centers 500ci

Bore	Thickness	Pkg Qty	Part #	List Price
4.675"051"	1	C5796-051	\$135.35
4.700"051"	1	C5797-051	\$135.35
4.780"051"	1	C5798-051	\$135.35

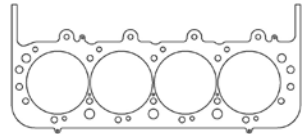

MLS Head Gasket - IHRA 5.00" Bore Centers 800ci

Bore	Thickness	Pkg Qty	Part #	List Price
4.755"040"	1	C5850-040	\$135.35

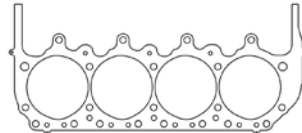

MLX Head Gasket - 5.20" Bore Centers

Bore	Thickness	Pkg Qty	Part #	List Price
4.860"040"	1	C5013-040	\$120.47

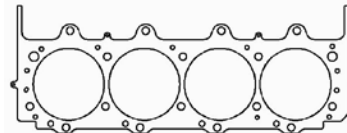

MLS Head Gaskets - BRODIX 5.0 Bore Space Big Block V8

Bore	Thickness	Pkg Qty	Part #	List Price
4.700"041"	1	C15397-041	\$135.35
4.760"041"	1	C15398-041	\$135.35
4.795"041"	1	C15399-041	\$135.35

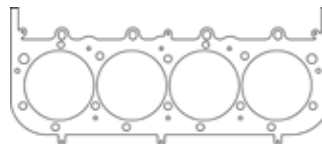

6.5L Diesel V8 1992-00

Head Gaskets

MLS Head Gaskets - Right Side

Bore	Thickness	Pkg Qty	Part #	List Price
4.100"045"	1	C5885-045	\$106.22

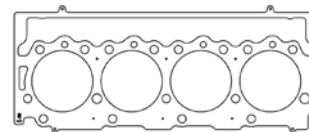

Additional thicknesses available
see page 5

MLS Head Gaskets - Left Side

Bore	Thickness	Pkg Qty	Part #	List Price
4.100"045"	1	C5884-045	\$106.22

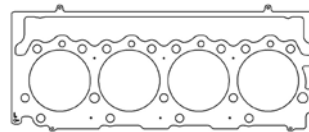

Head Bolt Kit

Bore	Part #	List Price
ARP 190,000 psi	COM-0001	\$283.40



CHEVROLET / GM

6.6L Duramax Diesel V8 2001-16

Head Gaskets

MLX Head Gaskets - Right Side

Bore	Thickness	Pkg Qty	Part #	List Price
4.130"053"1	C15375-053	\$206.65
4.130"062"1	C15375-062	\$206.65

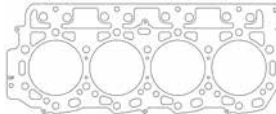

Additional thicknesses available
see page 5

MLX Head Gaskets - Left Side

Bore	Thickness	Pkg Qty	Part #	List Price
4.130"053"1	C15376-053	\$206.65
4.130"062"1	C15376-062	\$206.65

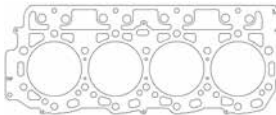

MLS Head Gaskets - Right Side

Bore	Thickness	Pkg Qty	Part #	List Price
4.100"040"1	C5882-040	\$155.86

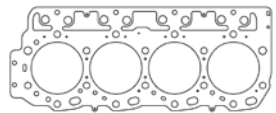

MLS Head Gaskets - Left Side

Bore	Thickness	Pkg Qty	Part #	List Price
4.100"040"1	C5883-040	\$155.86

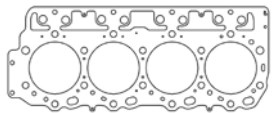

Individual Gaskets

Exhaust Manifold Gaskets

Application	Part #	List Price
2001-16 8mm Bolts - MLS, Pair	C15042-040	\$56.15

Rear Main Seal Kit

Application	Part #	List Price
2001-07	C15044	\$63.61

Timing Cover Set

Application	Part #	List Price
2001-15	C15045	\$44.38

Oil Pan Gasket Set

Application	Part #	List Price
2001-10 17 Bolt - .060" KF	C15043	\$19.18

Gasket Kits



To purchase a complete gasket kit order both top end and bottom end gasket kit

TOP END GASKET KITS



Application	Part #	List Price
6.6L Duramax 2001-04 4.100" Bore	PRO3008T	\$485.67
6.6L Duramax 2005-07 4.100" Bore	PRO3009T	\$597.07

BOTTOM END GASKET KIT



NEW!

Application	Part #	List Price
6.6L Duramax 2001-07	PRO3008B	\$184.88
6.6L Duramax 2007-10 LMM/LGH	PRO3011B	\$193.49



CHRYSLER / DODGE

2.0L DOHC 4cyl ECC / 420A 1995-99

Head Gaskets

MLS Head Gaskets				
Bore	Thickness	Pkg Qty	Part #	List Price
87.5mm	.040"	1	C5497-040	\$93.07
88.5mm	.040"	1	C5498-040	\$93.07

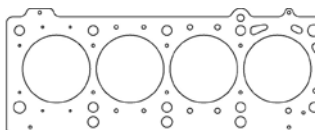

Additional thicknesses available see page 5

Individual Gaskets

Valve Cover Gasket Set		
Application	Part #	List Price
1995-99 2.0L DOHC	C15046	\$23.56

Cam Seal Set		
Application	Part #	List Price
Pair - 48 x 35 x 7	C15049	\$13.96

Intake Manifold Gaskets		
Application	Part #	List Price
Intake Manifold Gasket - .060" AFM	C15047-060	\$11.87
Intake Plenum Gasket - .031" Fiber	C15048-031	\$4.90

Front Crank Seal Set		
Application	Part #	List Price
1995-99 2.0L DOHC	C15053	\$21.41

Exhaust Manifold Gasket		
Application	Part #	List Price
2.040" X 1.100" Port - MLS	C4161-030	\$24.69

Oil Pan Gasket Set		
Application	Part #	List Price
Molded Rubber	C15050	\$29.69

Throttle Body Gasket		
Application	Part #	List Price
Molded Rubber	C15051	\$3.75

Rear Main Seal		
Application	Part #	List Price
1995-99 2.0L DOHC	C15052	\$13.67

Valve Stem Seal Set (16 Pack)		
Application	Part #	List Price
5 x 10.8 x 18.3 x 16.9 - Hat Style	3180V-16	\$33.79

Gasket Kits



To purchase a complete gasket kit order both top end and bottom end gasket kit

TOP END GASKET KIT

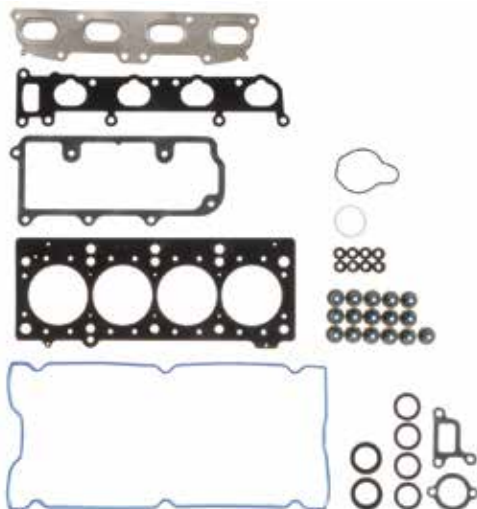

Application	Part #	List Price
1995-99 420A 2.0L DOHC 87.5mm Bore	PRO2005T	\$159.03

BOTTOM END GASKET KIT



Application	Part #	List Price
1995-99 420A 2.0L DOHC	PRO2005B	\$76.08



CHRYSLER / DODGE

**2.4L DOHC Turbo 4cyl 2003-05 Neon SRT4, 2002-10 PT Cruiser,
2003-06 Jeep Wrangler**

Head Gaskets

MLS Head Gaskets

Bore	Thickness	Pkg Qty	Part #	List Price
87.5mm	.030"	1	C4548-030	\$102.16
90mm	.030"	1	C4549-030	\$102.16

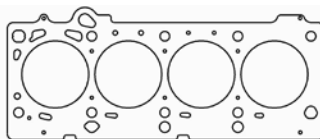

Additional thicknesses available
see page 5

MLX Head Gaskets

Bore	Thickness	Pkg Qty	Part #	List Price
88.5mm	.040"	1	C15449-040	\$114.39

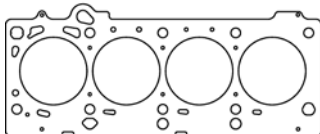

2.2L DOHC 4cyl 1991-93

Head Gaskets

MLS Head Gaskets

Bore	Thickness	Pkg Qty	Part #	List Price
89.5mm	.066"	1	C5733-066	\$141.78

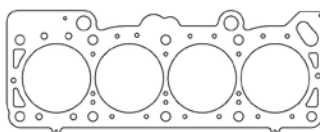

Additional thicknesses available
see page 5

2.2L SOHC 4cyl 1982-90, 2.5L SOHC 4cyl 1986-95

Head Gaskets

MLS Head Gaskets

Bore	Thickness	Pkg Qty	Part #	List Price
89.5mm	.066"	1	C5734-066	\$141.78

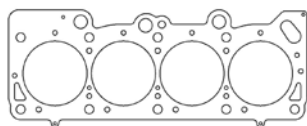

Additional thicknesses available
see page 5

3.5L SOHC V6 1999-10, 4.0L SOHC V6 2007-11

Head Gaskets

MLS Head Gasket - Right Side

Bore	Thickness	Pkg Qty	Part #	List Price
96.5mm	.075"	1	C5015-075	\$82.58

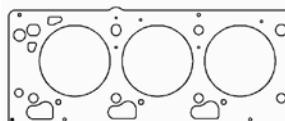

Additional thicknesses available
see page 5

MLS Head Gasket - Left Side

Bore	Thickness	Pkg Qty	Part #	List Price
96.5mm	.075"	1	C5016-075	\$82.58

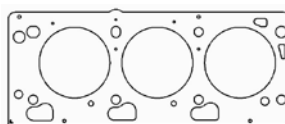

3.7L SOHC V6 2002-13 PowerTech "EKG"

Head Gaskets

MLS Head Gasket

Bore	Thickness	Pkg Qty	Part #	List Price
95mm	.030"	1	C5794-030	\$102.16

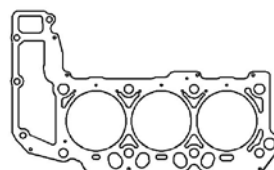

Additional thicknesses available
see page 5



CHRYSLER / DODGE

4.0L Inline 6 242ci 1987-2006: 87-01 Cherokee, 93-04 Grand Cherokee, 87-90 Wagoneer, 87-92 Comanche, 91-06 Wrangler

Head Gaskets

MLS Head Gaskets				
Bore	Thickness	Pkg Qty	Part #	List Price
3.950	.050"	1	C5987-050	\$124.76
4.000	.050"	1	C5988-050	\$124.76
4.060	.050"	1	C5989-050	\$124.76

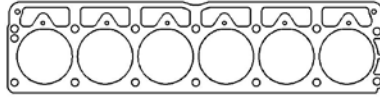

Additional thicknesses available
see page 5

Individual Gaskets

Timing Cover Set			
Application	Part #	List Price	
3.8/4.0/4.2L I6 1965-2006	C5047	\$17.66	

4.7L SOHC V8 1999-13 PowerTech

Head Gaskets

MLS Head Gaskets - 1999-07				
Bore	Thickness	Pkg Qty	Part #	List Price
93mm	.030"	1	C5213-030	\$102.16
95mm	.030"	1	C5214-030	\$102.16

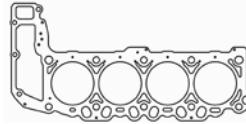

Additional thicknesses available
see page 5

MLS Head Gasket - 2008-13				
Bore	Thickness	Pkg Qty	Part #	List Price
94mm	.030"	1	C5803-030	\$102.16

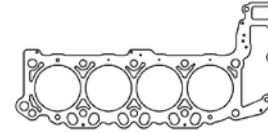

Individual Gaskets

Cooling/Water Pump Gaskets			
Application	Part #	List Price	
Thermostat Gasket 1999-13 3.7L V6/4.7L V8	C15168	\$3.69	

NEW!

Polyspherical 318 V8 1957-67 (A Engine)

Head Gaskets

MLS Head Gaskets				
Bore	Thickness	Pkg Qty	Part #	List Price
4.030"	.040"	1	C15296-040	\$107.17

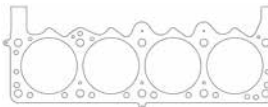

Additional thicknesses available
see page 5

5.2L & 5.9L Magnum V8 1992-03

Head Gaskets

MLS Head Gaskets				
Bore	Thickness	Pkg Qty	Part #	List Price
4.040"	.040"	1	C15535-040	\$93.07
4.040"	.051"	1	C15535-051	\$93.07
4.040"	.060"	1	C15535-060	\$121.99

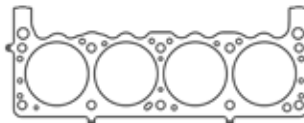

Additional thicknesses available
see page 5

Individual Gaskets

Valve Cover Gasket (sold individually)			
Application	Part #	List Price	
10 Bolt - .047" KF	C5557-047	\$30.59	

Oil Pan Gasket Set		
Application	Part #	List Price
4pc Set	C5560-094	\$31.88

Intake Manifold Gaskets		
Application	Part #	List Price
2.150" x 1.140" Port - .047" KF	C5555-047	\$20.35
End Rail Gaskets	C5556-047	\$7.64

Timing Cover Sets		
Application	Part #	List Price
1992-96	C5059	\$23.56
1997-03	C5060	\$23.56



CHRYSLER / DODGE

5.2L & 5.9L Magnum V8 1992-03

Individual Gaskets

Exhaust Manifold Gasket

Application	Part #	List Price
1.195" x 1.675" - .064" AM.....	C5558-064	\$25.52

Rear Main Seal

Application	Part #	List Price
2pc SN	C5564	\$49.82

Cooling/Water Pump Gaskets

Application	Part #	List Price
Water Pump Cover Gasket.....	C5561-018	\$11.47
Thermostat Gasket.....	C5562-018	\$1.70

Fuel Pump Gasket

Application	Part #	List Price
Fuel Pump to Block	C5642-031	\$2.36

318/340/360ci V8 "LA" 1964-92

Head Gaskets

MLS Head Gaskets

Bore	Thickness	Pkg Qty	Part #	List Price
4.040"040"	1.....	C5633-040	\$93.07
4.080"040"	1.....	C5622-040	\$93.07
4.125"040"	1.....	C5457-040	\$93.07
4.180"040"	1.....	C5456-040	\$93.07

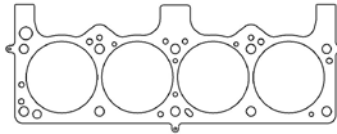

Additional thicknesses available
see page 5

MLS Head Gaskets - w/318A Engine Quest or Edelbrock Heads

Bore	Thickness	Pkg Qty	Part #	List Price
4.040"040"	1.....	C5916-040	\$102.16
4.080"040"	1.....	C5917-040	\$102.16
4.125"040"	1.....	C5918-040	\$102.16
4.180"040"	1.....	C5919-040	\$102.16

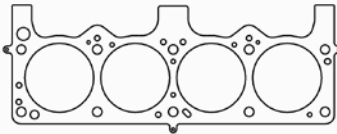

Copper Head Gaskets

Bore	Thickness	Pkg Qty	Part #	List Price
4.200"043"	1.....	C15416-043	\$116.62

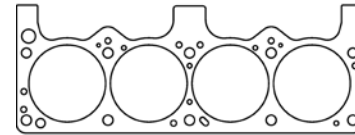

Individual Gaskets

Valve Cover Gasket (sold individually)

Application	Part #	List Price
Molded Rubber.....	C15468	\$30.84
5 Bolt - .094" KF.....	C5623-094	\$20.35

Timing Cover Set

Application	Part #	List Price
1964-91 Set.....	C5061	\$29.44

Intake Manifold Gaskets

Application	Part #	List Price
1.170" x 2.300" - .060" KF	C5624-060	\$30.59
China Rail Gaskets.....	C5625-060	\$7.64

Oil Pan Gasket Sets

Application	Part #	List Price
4pc 318/340ci V8.....	C5627-094	\$31.88
4pc 360ci V8.....	C5508-094	\$31.88

Exhaust Manifold Gaskets

Application	Part #	List Price
1.205" x 1.845" - .064" AM.....	C5628-064	\$24.23
1.310" x 1.640" - MLS.....	C5901-030	\$46.05

Rear Main Seal Kit

Application	Part #	List Price
273/318/340ci 2pc - SN.....	C5683	\$33.23
360ci 2pc - SN.....	C5684	\$30.59

Cooling / Water Pump Gaskets

Application	Part #	List Price
Water Pump Gasket	C15054-060	\$12.14
Thermostat Gasket.....	C5574-018	\$1.18

Fuel Pump Gasket

Application	Part #	List Price
Fuel Pump to Block	C5642-031	\$2.36

See page 31 for StreetPro gaskets



CHRYSLER / DODGE

318 / 340 / 360ci V8 "LA" 1964-92

Gasket Kits



To purchase a complete gasket kit order both top end and bottom end gasket kit

TOP END GASKET KIT



BOTTOM END GASKET KITS

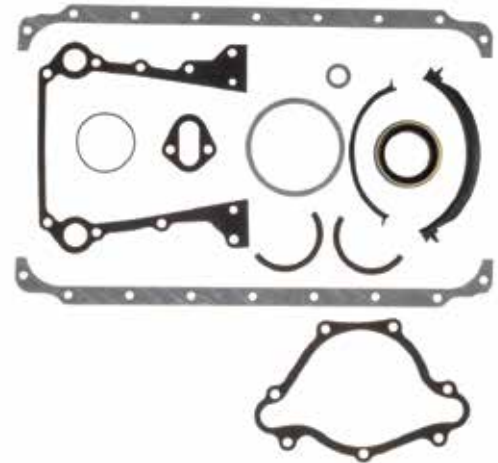

Application	Part #	List Price
1968-89 318, 1968-73 340, 1971-80 360 4.080" Bore	PRO1000T	\$199.23

Application	Part #	List Price
360ci V8	PRO1000B	\$68.76
318/340ci V8	PRO1002B	\$68.76

5.7L Hemi V8 2003-Present

Head Gaskets

MLX Head Gaskets - Right Side

Bore	Thickness	Pkg Qty	Part #	List Price
4.000"	.040"	1	C15315-040	\$125.03

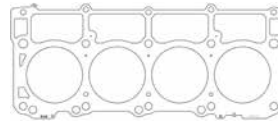

Additional thicknesses available see page 5

MLX Head Gaskets - Left Side

Bore	Thickness	Pkg Qty	Part #	List Price
4.000"	.040"	1	C15316-040	\$125.03

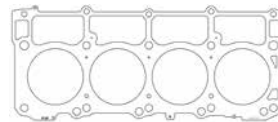

MLS Head Gaskets - Right Side

Bore	Thickness	Pkg Qty	Part #	List Price
3.950"	.027"	1	C5467-027	\$102.16
4.100"	.027"	1	C5749-027	\$102.16
4.100"	.040"	1	C5749-040	\$102.16

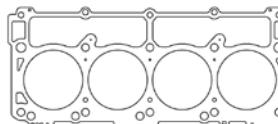

Additional thicknesses available see page 5

MLS Head Gaskets - Left Side

Bore	Thickness	Pkg Qty	Part #	List Price
3.950"	.027"	1	C5468-027	\$102.16
4.100"	.027"	1	C5750-027	\$102.16
4.100"	.040"	1	C5750-040	\$102.16

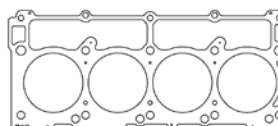

See page 32 for additional gaskets



CHRYSLER / DODGE

5.7L Hemi V8 2003-Present

Individual Gaskets

Valve Cover Gasket (sold individually)		
Application	Part #	List Price
Molded Rubber (Need 2)	C5193	\$17.66

Thermostat Housing Gasket		
Application	Part #	List Price
Molded Rubber	C5198	\$3.35

Intake Manifold Gasket Set		
Application	Part #	List Price
Molded Rubber - Set of 8	C5196	\$20.60

Oil Pan Gasket Set		
Application	Part #	List Price
Intergrated Windage Tray	C5201	\$70.58

Throttle Body Gasket		
Application	Part #	List Price
Molded Rubber	C5199	\$10.39

Timing Cover Set		
Application	Part #	List Price
2003-Up 5.7L Hemi	C5202	\$41.23

Exhaust Gaskets		
Application	Part #	List Price
MLS Exhaust Gaskets - Pair 2003-08	C5854-030	\$40.09

Rear Main Seal Kit		
Application	Part #	List Price
Seal and Housing Gasket	C5203	\$20.95

Valve Stem Seal Set (16 Pack)		
Application	Part #	List Price
Hat Style - SN Steel Body	3260V-16	\$66.84

Water Pump Gasket		
Application	Part #	List Price
Molded Rubber	C5204	\$7.02

Gasket Kits



To purchase a complete gasket kit order both top end and bottom end gasket kit

TOP END GASKET KIT

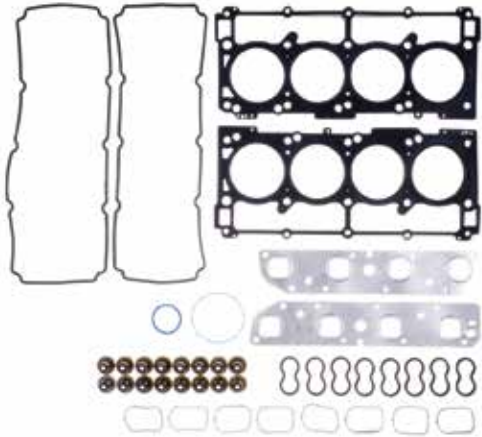

Application	Part #	List Price
2003-08 5.7L V8 3.950 Bore	PRO1022T	\$252.79

BOTTOM END GASKET KIT

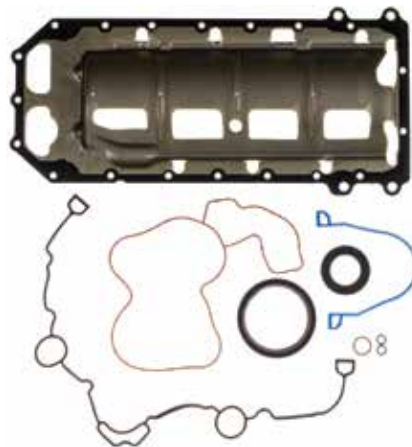

Application	Part #	List Price
2003-08 5.7L V8	PRO1022B	\$144.40

6.1L Hemi V8 2005-10

Head Gaskets

MLS Head Gaskets

Bore	Thickness	Pkg Qty	Part #	List Price
4.100"	.040"	1	C5876-040	\$102.16
4.125"	.036"	1	C5441-036	\$102.16
4.125"	.040"	1	C5441-040	\$102.16
4.185"	.040"	1	C5042-040	\$102.16
4.250"	.040"	1	C5890-040	\$102.16

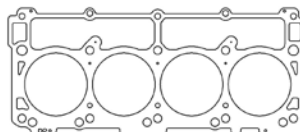

Additional thicknesses available see page 5

See page 33 for additional gaskets



CHRYSLER / DODGE

6.1L Hemi V8 2005-10

MLX Head Gasket

Bore	Thickness	Pkg Qty	Part #	List Price
4.100"	.040"	1	C15149-040	\$125.03
4.100"	.044"	1	C15149-044	\$125.03
4.100"	.054"	1	C15149-054	\$125.03
4.100"	.058"	1	C15149-058	\$125.03

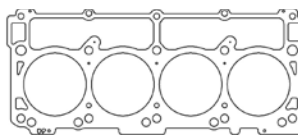

Additional thicknesses available see page 5

MLS Head Gaskets - Aluminum Sleeved Block

Bore	Thickness	Pkg Qty	Part #	List Price
4.055"	.040"	1	C5525-040	\$102.16
4.125"	.070"	1	C5526-070	\$141.78
4.125"	.075"	1	C5526-075	\$141.78
4.125"	.040"	1	C5526-040	\$102.16
4.185"	.040"	1	C5527-040	\$102.16

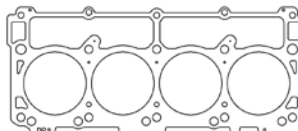

Individual Gaskets

Valve Cover Gasket (sold individually)

Application	Part #	List Price
Molded Rubber (Need 2)	C5193	\$17.66

Thermostat Housing Gasket

Application	Part #	List Price
Molded Rubber	C5198	\$3.48

Intake Manifold Gasket Set

Application	Part #	List Price
6.1L - .060" KF	C5197	\$37.62

Oil Pan Gasket Set

Application	Part #	List Price
Intergrated Windage Tray	C5529	\$88.51

Throttle Body Gasket

Application	Part #	List Price
Molded Rubber	C5199	\$10.39

Timing Cover Set

Application	Part #	List Price
2003-Up 5.7L Hemi	C5202	\$41.23

Exhaust Gaskets

Application	Part #	List Price
MLS Exhaust Gaskets - Pair	C5872-030	\$42.68

Rear Main Seal Kit

Application	Part #	List Price
Seal and Housing Gasket	C5203	\$20.95

NEW!

Valve Stem Seal Set (16 Pack)

Application	Part #	List Price
Hat Style - SN Steel Body - EXH	3260V-16	\$66.84
Hat Style - SN Steel Body - INT	3261V-16	\$43.49

Water Pump Gasket

Application	Part #	List Price
Molded Rubber	C5204	\$7.02

Gasket Kits



To purchase a complete gasket kit order both top end and bottom end gasket kit

TOP END GASKET KIT



Application	Part #	List Price
2005-10 6.1L Hemi V8 4.125" Bore	PRO1023T	\$270.49

BOTTOM END GASKET KIT

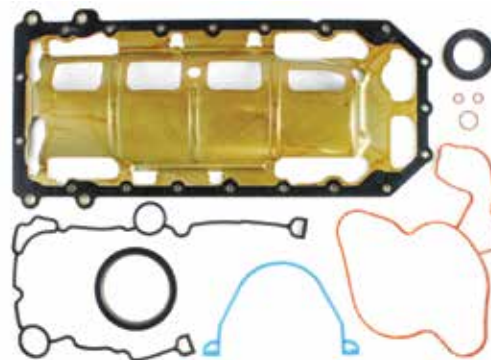

Application	Part #	List Price
2005-10 6.1L Hemi V8	PRO1023B	\$160.45



CHRYSLER / DODGE

6.2L Hemi V8 2015-Present "Hellcat"

Head Gaskets

MLX Head Gasket - Right Side

Bore	Thickness	Pkg Qty	Part #	List Price
4.150"040"1	C15292-040	\$125.03
4.150"054"1	C15292-054	\$125.03

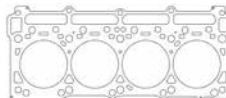

Additional thicknesses available
see page 5

MLX Head Gasket - Left Side

Bore	Thickness	Pkg Qty	Part #	List Price
4.150"040"1	C15293-040	\$125.03
4.150"054"1	C15293-054	\$125.03

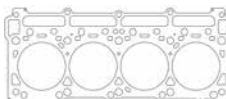

NEW!

SEG Head Gaskets - Right Side

Bore	Thickness	Pkg Qty	Part #	List Price
4.150"0.0511	C15558-051	\$264.61



NEW!

SEG Head Gaskets - Left Side

Bore	Thickness	Pkg Qty	Part #	List Price
4.150"0.0511	C15559-051	\$264.61

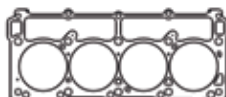

Individual Gaskets

Timing Cover Gasket

Application	Part #	List Price
2015-Up 6.2L Hemi	C5202	\$41.23

Intake Manifold Gasket Set

Application	Part #	List Price
2015-Up 6.2L Hemi	C51207	\$42.32
2015-Up 6.2L Hemi Supercharger Lid	C15553-060	\$49.04

6.4L Hemi V8 2011-Present "Apache"

Head Gaskets

MLS Head Gasket - Right Side

Bore	Thickness	Pkg Qty	Part #	List Price
4.120"040"1	C5026-040	\$102.16

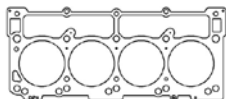

Additional thicknesses available
see page 5

MLS Head Gasket - Left Side

Bore	Thickness	Pkg Qty	Part #	List Price
4.120"040"1	C5027-040	\$102.16

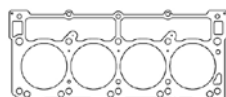

MLX Head Gasket - Right Side

Bore	Thickness	Pkg Qty	Part #	List Price
4.150"040"1	C15172-040	\$125.03
4.150"054"1	C15172-054	\$125.03

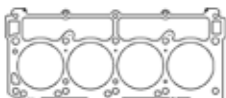

MLX Head Gasket - Left Side

Bore	Thickness	Pkg Qty	Part #	List Price
4.150"040"1	C15173-040	\$125.03
4.150"054"1	C15173-054	\$125.03



NEW!

SEG Head Gaskets - Right Side

Bore	Thickness	Pkg Qty	Part #	List Price
4.150"0.0511	C15558-051	\$264.61

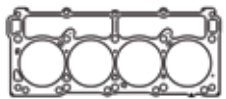

NEW!

SEG Head Gaskets - Left Side

Bore	Thickness	Pkg Qty	Part #	List Price
4.150"0.0511	C15559-051	\$264.61

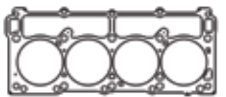

Individual Gaskets

Timing Cover Gasket

Application	Part #	List Price
2011-Up 6.4L Hemi	C5202	\$41.23

NEW!

Exhaust Gaskets

Application	Part #	List Price
2011-Up 6.4L Hemi - Pair	C15642-090	\$102.25



CHRYSLER / DODGE

6.4L Hemi V8 2011-Present "Apache"

Gasket Kits



To purchase a complete gasket kit order both top end and bottom end gasket kit

NEW!

TOP END GASKET KIT

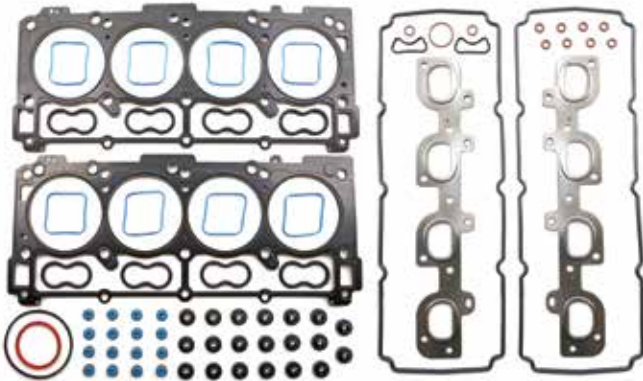

Application	Part #	List Price
2011-Up Chrysler 6.4L Apache Gen-3 Hemi	... PRO1048T ...	\$301.59

NEW!

BOTTOM END GASKET KIT

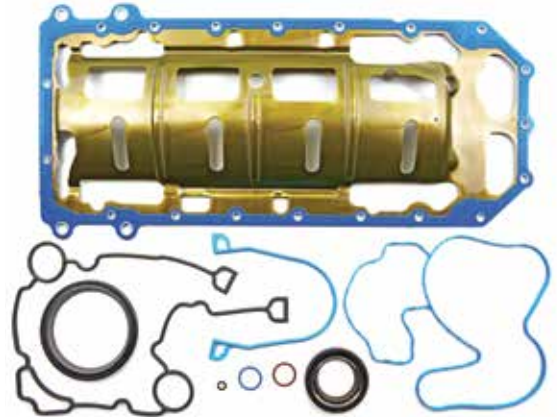

Application	Part #	List Price
2011-Up Chrysler 6.4L Apache Gen-3 Hemi	... PRO1048B ...	\$165.36

7.0L Hemi V8 2016-Present "Drag Pak"

Head Gaskets

MLX Head Gasket - Right Side

Bore	Thickness	Pkg Qty	Part #	List Price
4.200"054"1.....	C15391-054	\$119.67

MLX Head Gasket - Left Side

Bore	Thickness	Pkg Qty	Part #	List Price
4.200"054"1.....	C15392-054	\$119.67

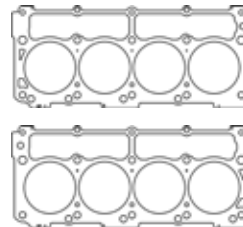

Additional thicknesses available see page 5

Small Block V8 - A-8 Sprint & A-4 Midget

Head Gaskets

MLS Head Gaskets - A-8 Sprint Block

Bore	Thickness	Pkg Qty	Part #	List Price
4.165"040"1.....	C5828-040	\$93.07
4.200"040"1.....	C5829-040	\$93.07
4.250"040"1.....	C5830-040	\$93.07

MLS Head Gaskets - A-4 Midget Block

Bore	Thickness	Pkg Qty	Part #	List Price
4.165"040"1.....	C5831-040	\$93.07
4.200"040"1.....	C5832-040	\$93.07

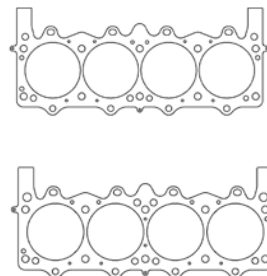

Additional thicknesses available see page 5

Individual Gaskets

Valve Cover Gasket (sold individually)

Application	Part #	List Price
Midget & Sprint Head C5784-060	\$17.24

Oil Pan Gasket Set

Application	Part #	List Price
Midget Block - .060" AFM C5596-060	\$26.73

Intake Manifold Gasket

Application	Part #	List Price
A-4 Midget Intake Gasket C5590	\$14.00



CHRYSLER / DODGE

Small Block V8 - R3 Block w/W2, W7, W8, or W9 Heads

Head Gaskets

MLS Head Gaskets - R3 Block w/W2 Heads

Bore	Thickness	Pkg Qty	Part #	List Price
4.100"	.040"	1	C5567-040	\$93.07
4.200"	.040"	1	C5466-040	\$93.07

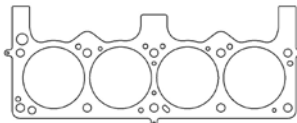

Additional thicknesses available
see page 5

MLS Head Gaskets - R3 Block w/W7, W8, W9 Heads

Bore	Thickness	Pkg Qty	Part #	List Price
4.060"	.040"	1	C5579-040	\$93.07
4.100"	.040"	1	C5580-040	\$93.07
4.165"	.040"	1	C5581-040	\$93.07
4.185"	.040"	1	C5582-040	\$93.07

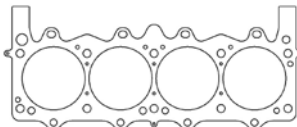

Individual Gaskets

Valve Cover Gaskets (sold individually)

Application	Part #	List Price
W2/W5/W7/W9 Heads	C5568-094	\$20.35
W8 Heads	C5592-094	\$16.58

Thermostat Gasket

Application	Part #	List Price
R3 Block	C5574-018	\$1.18

Intake Manifold Gaskets

Application	Part #	List Price
W2 Heads 1.35" x 2.07"	C5569-060	\$20.45
W7/W8/W9 Heads 1.45" x 2.20"	C5586-031	\$20.35
End Rail Gaskets	C5625-060	\$7.64

Oil Pan Gasket

Application	Part #	List Price
R3 Block - Rails Only	C5575-094	\$25.02

Exhaust Gaskets

Application	Part #	List Price
W2 Heads 1.47" x 1.45"	C5571-064	\$22.94
W7/W8/W9 Heads D-Port	C5593-064	\$24.93

Timing Cover Gasket

Application	Part #	List Price
R3 Block - .018" AFM	C5576-018	\$15.29

Water Pump Gasket

Application	Part #	List Price
R3 Block	C5573-018	\$9.33

Fuel Pump Gasket

Application	Part #	List Price
R3 Block - .031" Fiber	C5642-031	\$2.36

Small Block V8 - R4 Block w/P5 Heads

Head Gaskets

MLS Head Gaskets

Bore	Thickness	Pkg Qty	Part #	List Price
4.200"	.040"	1	C5801-040	\$102.16
4.250"	.040"	1	C5800-040	\$102.16

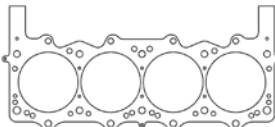

Additional thicknesses available
see page 5

Small Block V8 - R6 Race Block

Head Gaskets

MLX Head Gasket - Right Side

Bore	Thickness	Pkg Qty	Part #	List Price
4.220"	.040"	1	C5670-040	\$120.47

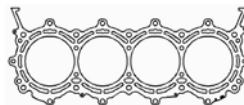

Additional thicknesses available
see page 5

MLX Head Gasket - Left Side

Bore	Thickness	Pkg Qty	Part #	List Price
4.220"	.040"	1	C5671-040	\$120.47

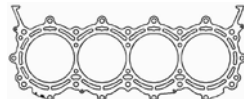



CHRYSLER / DODGE

Big Block Wedge 361, 383, 400, 413, 426, & 440ci V8

Head Gaskets

MLS Head Gaskets				
Bore	Thickness	Pkg Qty	Part #	List Price
4.250"	.040"	1	C5459-040	\$102.16
4.350"	.040"	1	C5460-040	\$102.16
4.380"	.040"	1	C5461-040	\$102.16
4.410"	.040"	1	C5462-040	\$102.16
4.500"	.040"	1	C5464-040	\$102.16
4.600"	.040"	1	C5799-040	\$102.16

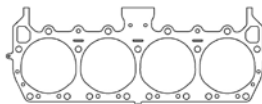

Additional thicknesses available see page 5

MLX Head Gaskets				
Bore	Thickness	Pkg Qty	Part #	List Price
4.500"	.040"	1	C15562-040	\$119.67

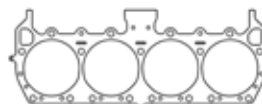

Copper Head Gaskets				
Bore	Thickness	Pkg Qty	Part #	List Price
4.400"	.043"	1	C15417-043	\$130.31

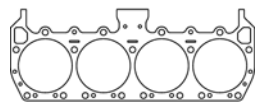

Individual Gaskets

Valve Cover Gasket (sold individually)		
Application	Part #	List Price
Molded Rubber	C5983	\$23.56

Oil Pan Gasket		
Application	Part #	List Price
Big Block Wedge V8-.060"AFM	C5617-060	\$16.58

Intake Manifold Gaskets		
Application	Part #	List Price
2.31" x 1.23" - .060" KF	C5611-060	\$20.35
End Rail Gaskets	C5612-060	\$8.27

Exhaust Gaskets		
Application	Part #	List Price
1.85" x 1.35" - .064" AM	C5619-064	\$24.23
1.78" x 1.46" - .030" MLS	C5902-030	\$49.83

Water Pump Gaskets		
Application	Part #	List Price
Pump to Block - Pair	C5615-032	\$11.47

Timing Cover Gasket Set		
Application	Part #	List Price
Big Block Wedge V8	C5062	\$29.44

Thermostat Gasket		
Application	Part #	List Price
Big Block Wedge V8	C5616-018	\$1.70

Fuel Pump Gasket		
Application	Part #	List Price
Fuel Pump to Block	C5642-031	\$2.36

Rear Main Seal Kit		
Application	Part #	List Price
2pc SN	C5686	\$34.91

Gasket Kits



To purchase a complete gasket kit order both top end and bottom end gasket kit

TOP END GASKET KIT



Application	Part #	List Price
Big Block Wedge V8 4.410" Bore	PRO1001T	\$199.23

BOTTOM END GASKET KIT



Application	Part #	List Price
Big Block Wedge V8	PRO1001B	\$75.64



CHRYSLER / DODGE

392 Hemi V8 1957-58

Head Gaskets

MLS Head Gaskets

Bore	Thickness	Pkg Qty	Part #	List Price
4.000"	.040"	1	C5210-045	\$102.16
4.100"	.040"	1	C5211-045	\$102.16

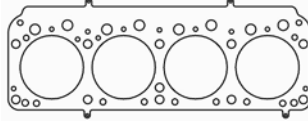

Additional thicknesses available see page 5

Copper Head Gaskets

Bore	Thickness	Pkg Qty	Part #	List Price
4.060"	.043"	1	C15418-043	\$116.62

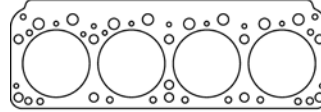

Individual Gaskets

Valve Cover Gaskets

Application	Part #	List Price
392 Hemi - 188" ML (pair)	C5236-188	\$47.12

Oil Pan Gasket Set

Application	Part #	List Price
1958-59 4pc Set	C15055	\$39.61

Intake Manifold Gasket Set

Application	Part #	List Price
Includes Valley Gasket	C5237	\$65.93

Distributor Gasket

Application	Part #	List Price
392 Hemi - .031" Fiber	C5239-031	\$1.75

Exhaust Gaskets

Application	Part #	List Price
1957-58 - .064" AM	C5238-064	\$37.12

Timing Cover Gasket Set

Application	Part #	List Price
1955-59 Early Hemi	C5063	\$29.44

Cooling/Water Pump Gaskets

Application	Part #	List Price
Pump to Block - 4 Pack	C5228-060	\$8.24
Water Outlet	C5229-060	\$4.19
Water Inlet	C5230-032	\$1.70

Carburetor Gasket Kits

Application	Part #	List Price
392 Hemi 2bbl Kit	C5240	\$8.92
392 Hemi 4bbl Kit	C5241	\$15.10

Gasket Kits



To purchase a complete gasket kit order both top end and bottom end gasket kit

TOP END GASKET KIT



Application	Part #	List Price
392 Hemi V8 1957-58 4.100" Bore	PRO1028T	\$182.09

BOTTOM END GASKET KIT

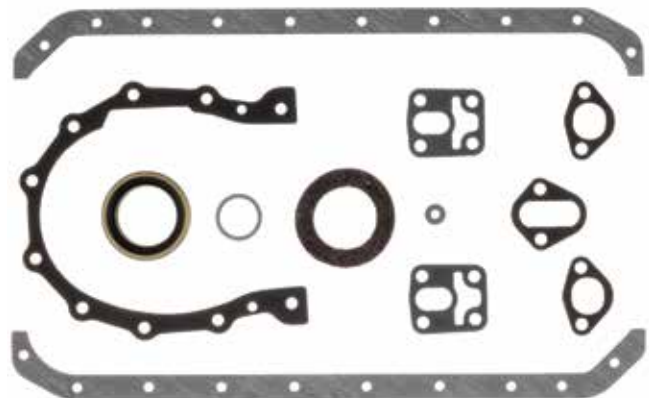

Application	Part #	List Price
392 Hemi V8 1957-58	PRO1028B	\$75.63



CHRYSLER / DODGE

426 Hemi 1966 & Later

Head Gaskets

MLS Head Gaskets (Gasket bores .060" larger than listed)

Bore	Thickness	Pkg Qty	Part #	List Price
4.250"	.040"	1	C5445-040	\$102.16
4.280"	.040"	1	C5454-040	\$102.16
4.310"	.040"	1	C5455-040	\$102.16
4.375"	.040"	1	C5446-040	\$102.16
4.500"	.040"	1	C5447-040	\$102.16

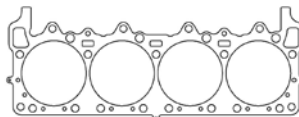

Additional thicknesses available
see page 5

Copper Head Gaskets

Bore	Thickness	Pkg Qty	Part #	List Price
4.320"	.043"	1	C15419-043	\$130.31

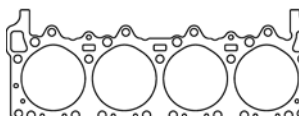

Individual Gaskets

Valve Cover Gasket (sold individually)

Application	Part #	List Price
Molded Rubber	C5976	\$23.56

Oil Pump Gasket

Application	Part #	List Price
426 Hemi	C5604-032	\$6.87

Intake Manifold Gaskets

Application	Part #	List Price
1.85" x 2.00" - .047" KF	C5598-047	\$20.35

Oil Pan Gasket

Application	Part #	List Price
426 Hemi - .060" AFM	C5606-060	\$16.58

Exhaust Gaskets

Application	Part #	List Price
1.84" x 1.89" - .030" MLS	C5965-030	\$42.57

Fuel Pump Gasket

Application	Part #	List Price
Fuel Pump to Block	C5642-031	\$2.36

Cooling / Water Pump Gaskets

Application	Part #	List Price
Pump to Block - Pair	C5601-018	\$11.47
Pump to Housing	C5602-032	\$11.47
Thermostat Gasket	C5603-018	\$1.70

Rear Main Seal Kit

Application	Part #	List Price
2pc SN	C5686	\$34.91

Distributor Gasket

Application	Part #	List Price
426 Hemi	C5607-060	\$1.35

Timing Cover Gasket Set

Application	Part #	List Price
426 Hemi	C5062	\$29.55

Gasket Kits



To purchase a complete gasket kit order both top end and bottom end gasket kit

TOP END GASKET KIT



Application	Part #	List Price
426 Hemi 7.0L 1966-71 4.100" Bore	PRO1021T	\$177.81

BOTTOM END GASKET KIT



Application	Part #	List Price
426 Hemi 7.0L 1966-71	PRO1021B	\$87.10



CHRYSLER / DODGE

8.0L V10 1992-Early 96 (Gen 1 Viper)

Head Gaskets

MLS Head Gaskets

Bore	Thickness	Pkg Qty	Part #	List Price
4.030"	.051"	1	C5113-051	\$215.19
4.165"	.051"	1	C5114-051	\$215.19

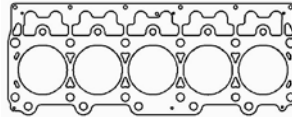

Additional thicknesses available
see page 5

Individual Gaskets

Intake Manifold Gaskets

Application	Part #	List Price
1992-1996 Gen 1 - .039" Fiber	C5827-039	\$22.98

Exhaust Manifold Gaskets

Application	Part #	List Price
1992-96 Gen 1 - .030" MLS	C5679-030	\$34.48

8.0 / 8.3L V10 Late 1996-07 (Gen 2/3 Viper)

Head Gaskets

MLS Head Gasket

Bore	Thickness	Pkg Qty	Part #	List Price
4.060"	.051"	1	C5814-051	\$135.35
4.125"	.051"	1	C5815-051	\$135.35
4.165"	.051"	1	C5816-051	\$135.35

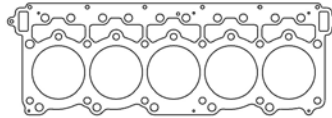

Additional thicknesses available
see page 5

MLX Head Gasket w/1/2" Studs

Bore	Thickness	Pkg Qty	Part #	List Price
4.125"	.054"	1	C5585-054	\$199.65

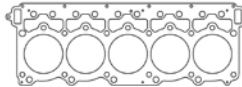

MLX Head Gasket w/9/16" Studs

Bore	Thickness	Pkg Qty	Part #	List Price
4.125"	.054"	1	C5487-054	\$199.65

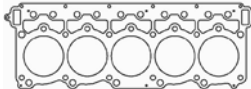

Individual Gaskets

Intake Manifold Gasket

Application	Part #	List Price
1996-2002 Gen 2 - .039" Fiber	C5827-039	\$22.98

Exhaust Manifold Gaskets

Application	Part #	List Price
1996-03 Gen 2 - .020" MLS	C5825-020	\$34.48
2004-07 Gen 3 - .030" MLS	C5865-030	\$34.48

Water Pump Gasket

Application	Part #	List Price
1996-02 Gen 2 - .032" AFM	C15582	\$15.76

Oil Filter Adapter Gasket

Application	Part #	List Price
1996-02 Gen 2 - .032" AFM	C15583	\$7.13

Timing Cover Gasket

Application	Part #	List Price
1996-02 Gen 2 - .032" AFM	C15581	\$19.91

Oil Pan Gasket

Application	Part #	List Price
1996-02 Gen 2 - .225" 3 Layer AFM	C15507	\$204.60

8.4L V10 2008-10 , (Gen 4 Viper)

Head Gaskets

MLS Head Gasket

Bore	Thickness	Pkg Qty	Part #	List Price
4.125"	.045"	1	C5107-045	\$135.35

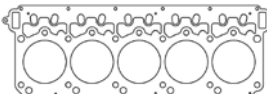

Additional thicknesses available
see page 5

MLX Head Gasket w/9/16" Studs

Bore	Thickness	Pkg Qty	Part #	List Price
4.125"	.054"	1	C5504-054	\$199.65

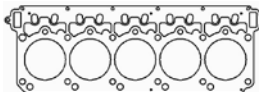

Individual Gaskets

Exhaust Manifold Gasket Set

Application	Part #	List Price
2008-2010 Gen-4 MLS	C15150-040	\$56.12



CHRYSLER / DODGE

8.4L V10 2013-17 (Gen 5 Viper)

Head Gaskets

MLS Head Gasket - Left Side

Bore	Thickness	Pkg Qty	Part #	List Price
4.125"	.040"	1	C15377-040	\$135.35

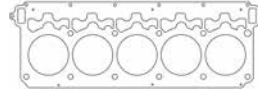

Additional thicknesses available
see page 5

MLS Head Gasket - Right Side

Bore	Thickness	Pkg Qty	Part #	List Price
4.125"	.040"	1	C15378-040	\$135.35

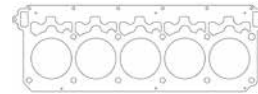

MLX Head Gasket - Left Side

Bore	Thickness	Pkg Qty	Part #	List Price
4.125"	.040"	1	C15431-040	\$167.62
4.125"	.049"	1	C15431-049	\$199.65
4.125"	.052"	1	C15431-052	\$199.65

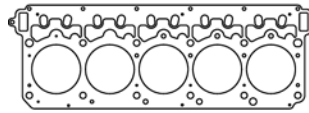

MLS Head Gasket - Right Side

Bore	Thickness	Pkg Qty	Part #	List Price
4.125"	.040"	1	C15432-040	\$167.62
4.125"	.049"	1	C15432-049	\$199.65
4.125"	.052"	1	C15432-052	\$199.65

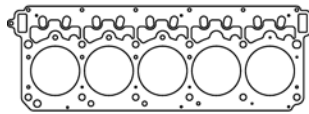

Individual Gaskets

Exhaust Manifold Gasket Set

Application	Part #	List Price
2013-2017 Gen-5 MLS	C15150-040	\$56.12

Pro Stock Hemi 500ci V8

Head Gaskets

MLS Head Gaskets - Gen1 Hemi 99

Bore	Thickness	Pkg Qty	Part #	List Price
4.660"	.051"	1	C5444-051	\$135.35
4.685"	.051"	1	C5443-051	\$135.35
4.700"	.051"	1	C5442-051	\$135.35
4.720"	.051"	1	C5438-051	\$135.35

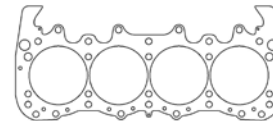

Additional thicknesses available
see page 5

MLS Head Gaskets - Gen2 "DPS2"

Bore	Thickness	Pkg Qty	Part #	List Price
4.750"	.050"	1	C5045-050	\$167.62

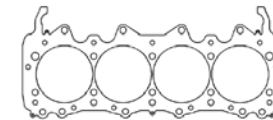

CUMMINS

3.9L 4BT Diesel 4cyl 1983+

Head Gasket

MLX Head Gasket

Bore	Thickness	Pkg Qty	Part #	List Price
4.100"	.061"	1	C5591-061	\$123.73

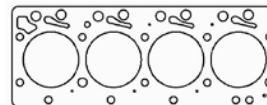

Additional thicknesses available
see page 5

Individual Gaskets

Valve Cover Gasket Set

Application	Part #	List Price
3.9L 4BT	C15056	\$23.56

Thermostat Housing Seal

Application	Part #	List Price
3.9L 4BT	C15059	\$2.56

Intake Manifold Gaskets

Application	Part #	List Price
3.9L 4BT	C15057	\$11.33

Oil Pan Gasket

Application	Part #	List Price
3.9L 4BT - .031" Fiber	C15060	\$32.62

See page 42 for additional gaskets



CUMMINS

3.9L 4BT Diesel 4cyl 1983+

Exhaust Manifold Gaskets Set

Application	Part #	List Price
3.9L 4BT - 4 Pack	C15058	\$23.70

Valve Stem Seal

Application	Part #	List Price
8x12.3x12x17 Viton - Need 8	3164V	\$1.98

Timing Cover Seal

Application	Part #	List Price
3.9L 4BT	C15063	\$78.32

Water Pump Gasket

Application	Part #	List Price
3.9L 4BT 1983-97 - O-Ring	C15065	\$1.77

Rear Main Seal

Application	Part #	List Price
3.9L 4BT	C15062	\$77.62

Pushrod Cover Gasket

Application	Part #	List Price
3.9L 4BT 1983-97	C15064	\$15.34

Fuel Pump Gaskets

Application	Part #	List Price
Fuel Pump Gasket	C5389-032	\$1.86
Injection Pump Gasket	C15061	\$4.07

Gasket Kits



To purchase a complete gasket kit order both top end and bottom end gasket kit

TOP END GASKET KIT

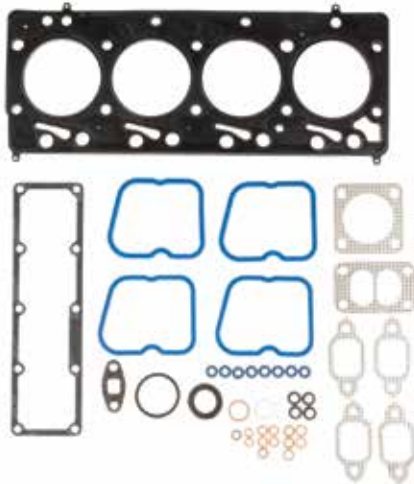

Application	Part #	List Price
3.9L 4BT 4cyl Diesel 4.100" Bore	PRO3000T	\$221.64

BOTTOM END GASKET KIT



Application	Part #	List Price
3.9L 4BT 4cyl Diesel	PRO3000B	\$221.64

5.9L 12v 6BT Inline 6 Diesel 1992-98

Head Gasket

MLX Head Gasket

Bore	Thickness	Pkg Qty	Part #	List Price
4.100"	.061"	1	C5955-061	\$243.84

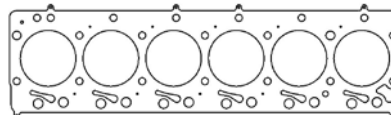

Additional thicknesses available see page 5

Individual Gaskets

Valve Cover Gasket Set

Application	Part #	List Price
5.9L 6BT 1992-98	C15066	\$41.23

Thermostat Housing Seal

Application	Part #	List Price
5.9L 6BT 1992-98	C15059	\$2.56

Intake Manifold Gasket Set

Application	Part #	List Price
5.9L 6BT 1992-98	C15067	\$46.04

Oil Pan Gasket

Application	Part #	List Price
5.9L 6BT 1992-98	C15068	\$39.41

See page 43 for additional gaskets



CUMMINS

5.9L 12v 6BT Inline 6 Diesel 1992-98

Individual Gaskets

Exhaust Manifold Gaskets Set		
Application	Part #	List Price
5.9L 6BT 1992-98 - .040" MLS	C5725-040	\$51.73

Rear Main Seal		
Application	Part #	List Price
5.9L 6BT 1992-98	C15062	\$77.62

Valve Stem Seal		
Application	Part #	List Price
8x12.3x12x17 SN - Need 12	3164V	\$1.98

Pushrod Cover Gasket		
Application	Part #	List Price
5.9L 6BT 1989-99	C15069	\$14.70

Timing Cover Seal		
Application	Part #	List Price
5.9L 6BT 1992-98	C15063	\$78.32

Fuel Pump Gasket		
Application	Part #	List Price
Fuel Pump Gasket	C5389-032	\$1.86
Injection Pump Gasket	C15061	\$4.07

Water Pump Gasket		
Application	Part #	List Price
3.9L 4BT 1983-98 - O-Ring	C15065	\$1.77

Gasket Kits



To purchase a complete gasket kit order both top end and bottom end gasket kit

TOP END GASKET KIT

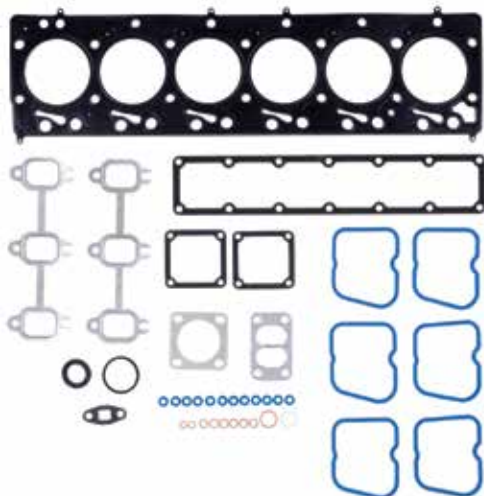

Application	Part #	List Price
5.9L 6BT I6 Diesel 92-98 4.100" Bore	PRO3001T	\$389.86

BOTTOM END GASKET KIT



Application	Part #	List Price
5.9L 6BT I6 Diesel 92-98	PRO3001B	\$251.72

5.9L 24v ISB Inline 6 Diesel 1998.5-02

Head Gasket

MLX Head Gasket				
Bore	Thickness	Pkg Qty	Part #	List Price
4.100"061"1.....	C5855-061	\$243.84

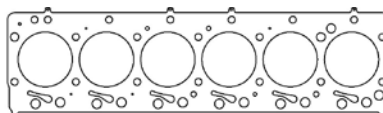

Additional thicknesses available see page 5

Individual Gaskets

Valve Cover Gasket Set		
Application	Part #	List Price
5.9L ISB 1998.5-02	C5614	\$92.79

Oil Pan Gasket		
Application	Part #	List Price
5.9L 6BT 1998.5-02	C15068	\$39.41

See page 44 for additional gaskets



CUMMINS

5.9L 24v ISB Inline 6 Diesel 1998.5-02

Individual Gaskets

Intake Manifold Gasket Set

Application	Part #	List Price
5.9L ISB 1998.5-02.....	C15067	\$46.04

Rear Main Seal

Application	Part #	List Price
5.9L 6BT 1998.5-02.....	C15062	\$77.62

Exhaust Manifold Gaskets Set

Application	Part #	List Price
5.9L ISB 1998.5-02.....	C5726-040	\$51.73

Pushrod Cover Gasket

Application	Part #	List Price
5.9L 6BT 1998.5-02.....	C15069	\$14.70

Valve Stem Seals

Application	Part #	List Price
Intake VSS - Yellow (Need 12).....	3214V	\$2.34
Exhaust VSS-Green(Need 12).....	3215V	\$3.06

Water Pump Gasket

Application	Part #	List Price
3.9L 4BT 1998.5-02 - O-Ring.....	C15065	\$1.77

Timing Cover Seal

Application	Part #	List Price
5.9L 6BT 1998.5-02.....	C15063	\$78.32

Gasket Kit



To purchase a complete gasket kit order both top end and bottom end gasket kit

TOP END GASKET KIT

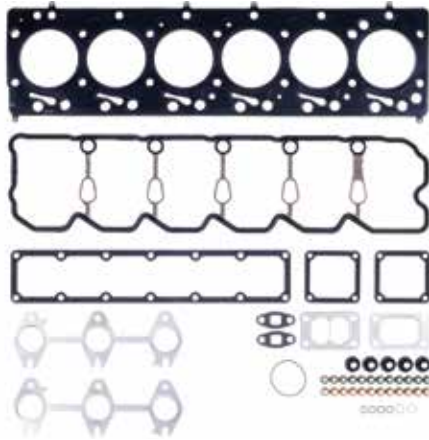

Application	Part #	List Price
5.9L 24v ISB 6cyl 1998.5-02.....	PRO3002T	\$423.28

BOTTOM END GASKET KIT

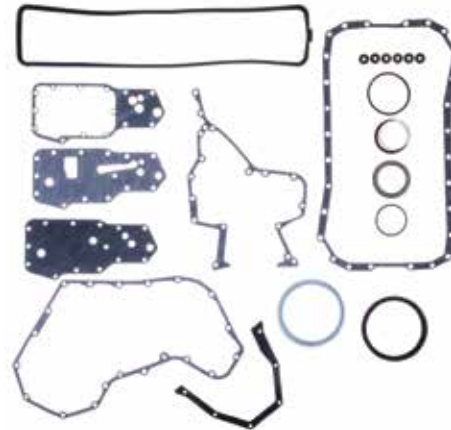

Application	Part #	List Price
5.9L 24v ISB 6cyl 1998.5-02.....	PRO3002B	\$178.19

5.9L 24v ISB Common Rail Inline 6 Diesel 2003-07

Head Gasket

MLX Head Gasket

Bore	Thickness	Pkg Qty	Part #	List Price
4.100"061"1.....	C5597-061	\$243.84

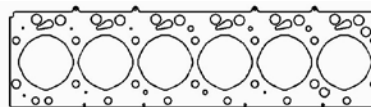

Additional thicknesses available see page 5

See page 45 for additional gaskets



CUMMINS

5.9L 24v ISB Common Rail Inline 6 Diesel 2003-07

Individual Gaskets

Fuel Injector Seal Kit		
Application	Part #	List Price
5.9L Common Rail 2003-07.....	C15072	\$41.23

Valve Stem Seals		
Application	Part #	List Price
Intake VSS - Yellow (Need 12)	3218V	\$1.92
Exhaust VSS-Green(Need 12)	3219V	\$1.92

Valve Cover Gasket Set		
Application	Part #	List Price
5.9L Common Rail 2003-07.....	C15070	\$45.75

Pushrod Cover Gasket		
Application	Part #	List Price
5.9L Common Rail 2003-07.....	C15071	\$14.84

Intake Manifold Gasket Set		
Application	Part #	List Price
5.9L Common Rail 2003-07.....	C15067	\$46.75

Thermostat Seal		
Application	Part #	List Price
5.9L Common Rail 2003-07.....	C15073	\$7.39

Exhaust Manifold Gaskets Set		
Application	Part #	List Price
5.9L Common Rail 2003-07.....	C5726-040	\$51.73

Oil Pan Gasket Kit		
Application	Part #	List Price
AFM Material (Includes Pump Pick Up).....	C15470	\$45.75

Gasket Kit



TOP END GASKET KIT

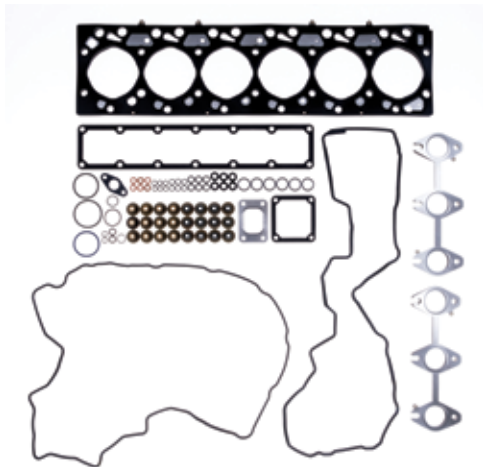

Application	Part #	List Price
5.9L 24v Common Rail 03-07.....	PRO3003T	\$452.25

BOTTOM END GASKET KIT

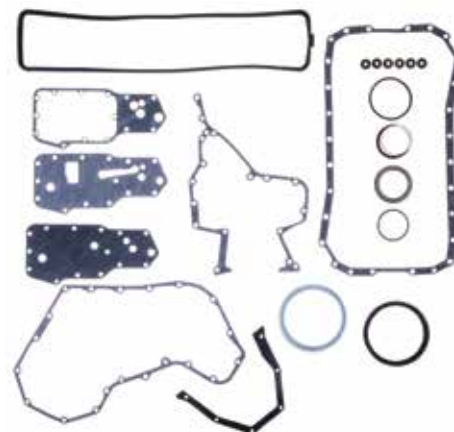

Application	Part #	List Price
5.9L 24v Common Rail 03-07.....	PRO3002B	\$178.19

6.7L 24v ISB Inline 6 Diesel 2007.5+Up

Head Gasket

MLX Head Gasket				
Bore	Thickness	Pkg Qty	Part #	List Price
4.312"	.052"	1.....	C5609-052	\$243.84
4.312"	.056"	1.....	C5609-056	\$243.84
4.312"	.089"	1.....	C5609-089	\$281.09

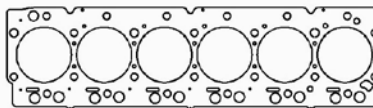

Additional thicknesses available
see page 5

See page 46 for additional gaskets



CUMMINS

6.7L 24v ISB Inline 6 Diesel 2007.5+Up

Individual Gaskets

Valve Stem Seal		
Application	Part #	List Price
VSS - Yellow (Need 24)	3218V	\$1.92

Rear Main Seal		
Application	Part #	List Price
6.7L 24v ISB 2007.5+Up	C15062	\$77.62

Intake Gasket Set		
Application	Part #	List Price
6.7L 24v ISB 2007.5+	C15076	\$46.75

Timing Cover Seal		
Application	Part #	List Price
6.7L 24v ISB 2007.5+Up	C15063	\$78.32

Exhaust Manifold Gaskets Set		
Application	Part #	List Price
6.7L 24v ISB 2007.5+Up (MLS)	C5726-040	\$51.73

Water Pump Gasket		
Application	Part #	List Price
6.7L 24v ISB 2007.5+Up	C15065	\$1.77

Thermostat Seal		
Application	Part #	List Price
6.7L 24v ISB 2007.5+Up	C15073	\$7.39

Oil Cooler Gasket Set		
Application	Part #	List Price
6.7L 24v ISB 2007.5+Up	C15075	\$46.69

Oil Pan Gasket		
Application	Part #	List Price
6.7L 24v ISB 2007.5+Up	C15074	\$60.38

Pushrod Cover Gasket		
Application	Part #	List Price
6.7L 24v ISB 2007.5+Up	C15071	\$14.84

Gasket Kits



To purchase a complete gasket kit order both top end and bottom end gasket kit

TOP END GASKET KIT

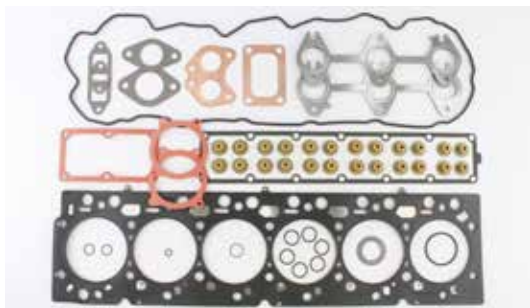

Application	Part #	List Price
6.7L 24v ISB 6cyl 2007.5+Up 4.312" Bore	PRO3004T	\$452.25

BOTTOM END GASKET KIT



Application	Part #	List Price
6.7L 24v ISB 6cyl 2007.5+Up	PRO3004B	\$217.18

FORD

1.0L 2014-Up Fox EcoBoost

Head Gasket

NEW!

MLX Head Gasket

Bore	Thickness	Pkg Qty	Part #	List Price
73mm	.032"	1	C14140-032	\$100.57

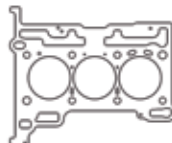

Additional thicknesses available see page 5

1.6L Duratec Ti-VCT 2011-16

Head Gasket

MLX Head Gasket

Bore	Thickness	Pkg Qty	Part #	List Price
82mm	.028"	1	C4963-028	\$120.47

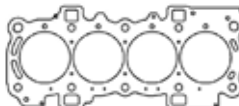

Additional thicknesses available see page 5



FORD

1.6L & 1.8L CVH 4cyl 1985-93

Head Gasket

MLS Head Gasket				
Bore	Thickness	Pkg Qty	Part #	List Price
83mm	.051"	1	C5756-051	\$102.16

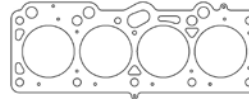

Additional thicknesses available see page 5

1.9L CVH 4cyl 1985-96

Head Gasket

MLS Head Gasket				
Bore	Thickness	Pkg Qty	Part #	List Price
82mm	.051"	1	C5136-051	\$102.16

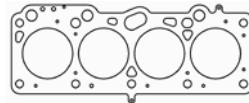

Additional thicknesses available see page 5

2.0L SOHC/DOHC NEP/YB Group A

Head Gasket

MLS Head Gasket				
Bore	Thickness	Pkg Qty	Part #	List Price
92.5mm	.040"	1	C4350-040	\$97.27

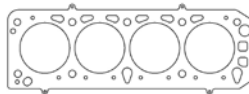

Additional thicknesses available see page 5

Individual Gaskets

Intake Gasket Set		
Application	Part #	List Price
Cosworth YB	C4502	\$45.38

Oil Pan Gasket		
Application	Part #	List Price
Cosworth YB Rails only	C4640	\$17.10

Exhaust Manifold Gasket Set		
Application	Part #	List Price
Cosworth YB	C4334	\$18.22

Front Cover Gasket		
Application	Part #	List Price
Cosworth YB	C4641	\$10.18

Valve Cover Gaskets		
Application	Part #	List Price
Early YB Engine - .060" AFM	C4635	\$30.69
Late YB Engine - .060" AFM	C4636	\$30.69

Cooling/Water Pump Gasket		
Application	Part #	List Price
Water Pump Gasket	C4637	\$5.80
Water Outlet Gasket	C4638	\$2.58
Thermostat Gasket	C4639	\$2.42

2.0L ZETEC DOHC 4cyl 1995-04

Head Gasket

MLS Head Gasket				
Bore	Thickness	Pkg Qty	Part #	List Price
87mm	.027"	1	C4279-027	\$93.07

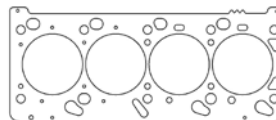

Additional thicknesses available see page 5

Individual Gaskets

Valve Cover Gaskets		
Application	Part #	List Price
2.0L Zetec DOHC 1995-97	C4643	\$29.44
2.0L Zetec DOHC 1998-04	C4644	\$29.44

Valve Stem Seals		
Application	Part #	List Price
2.0L Zetec 1995-97 (16pk)	3181V-16	\$46.34
2.0L Zetec 1998-04 (16pk)	3182V-16	\$49.91

Exhaust Manifold Gasket Set		
Application	Part #	List Price
2.0L Zetec 1994-04	C4645	\$19.18

Oil Pan Gasket		
Application	Part #	List Price
2.0L Zetec 1995-04	C4649	\$27.45

See page 48 for additional gaskets



FORD

2.0L Zetec DOHC 4cyl 1995-04

Individual Gaskets

Intake Gasket Sets

Application	Part #	List Price
2.0L Zetec 1998-04	C4646	\$15.65
2.0L Zetec 1995-97	C4647	\$46.99

Thermostat Gaskets

Application	Part #	List Price
2.0L Zetec 1995-04 - Seal	C4651	\$1.92
2.0L Zetec 1995-04 - Housing	C4652	\$4.91

Cam Seal

Application	Part #	List Price
2.0L Zetec 1994-04	C4648	\$13.84

Rear Main Seal Set

Application	Part #	List Price
2.0L Zetec 1995-04	C4650	\$17.08

Gasket Kits



To purchase a complete gasket kit order both top end and bottom end gasket kit

TOP END GASKET KITS

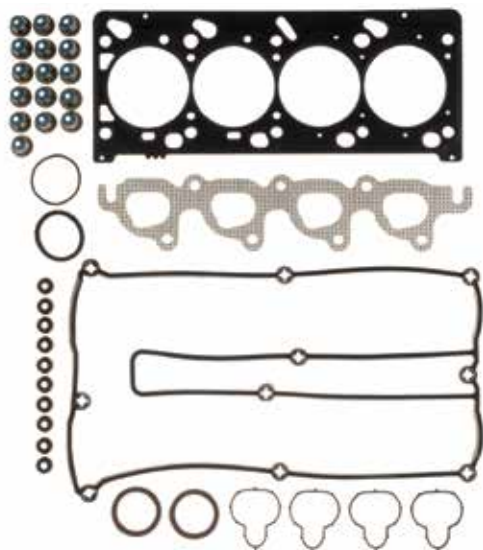

Application	Part #	List Price
2.0L Zetec DOHC 1995-97 87mm Bore	PRO2029T	\$245.39
2.0L Zetec DOHC 1998-04 87mm Bore	PRO2030T	\$245.39

BOTTOM END GASKET KITS



Application	Part #	List Price
2.0L Zetec DOHC 1995-97	PRO2029B	\$113.58
2.0L Zetec DOHC 1998-04	PRO2030B	\$113.58

2.3L "2300" SOHC 1974-97 4cyl

Head Gaskets

MLS Head Gaskets

Bore	Thickness	Pkg Qty	Part #	List Price
3.830"	.040"	1	C5369-040	\$76.56
3.940"	.040"	1	C5709-040	\$76.56

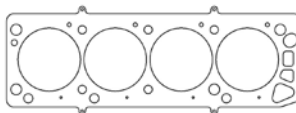

Additional thicknesses available
see page 5

Individual Gaskets

Valve Cover Gaskets

Application	Part #	List Price
2300 2.3L 1974-93	C4653	\$23.56

Exhaust Manifold Gasket Set

Application	Part #	List Price
2300 2.3L 1974-93	C5372-064	\$16.58

See page 49 for additional gaskets



FORD

2.3L "2300" SOHC 1974-97 4cyl

Individual Gaskets

Intake Gasket Set		
Application	Part #	List Price
2300 2.3L	C5371-060	\$14.06

Valve Stem Seals		
Application	Part #	List Price
2300 2.3L 1974-93 (need 8)	3168V	\$2.53

Water Pump Gasket		
Application	Part #	List Price
2300 2.3L 1974-93	C4654	\$2.56

Oil Pan Gaskets		
Application	Part #	List Price
2300 2.3L 1974-2/19/86	C5373	\$17.68
2300 2.3L 2/20/86-1990	C4669	\$27.68
2300 2.3L 1991-92	C4741	\$21.74
2300 2.3L 1993.....	C4778	\$21.74

Rear Main Seal Sets		
Application	Part #	List Price
2300 2.3L 1974-81 2pc.....	C5688	\$29.35
2300 2.3L 1982-93 1pc.....	C5189	\$18.49

Gasket Kits



To purchase a complete gasket kit order both top end and bottom end gasket kit

TOP END GASKET KIT



Application	Part #	List Price
2300 2.3L 1974-97 3.830" Bore.....	PRO2031T	\$204.48

BOTTOM END GASKET KIT

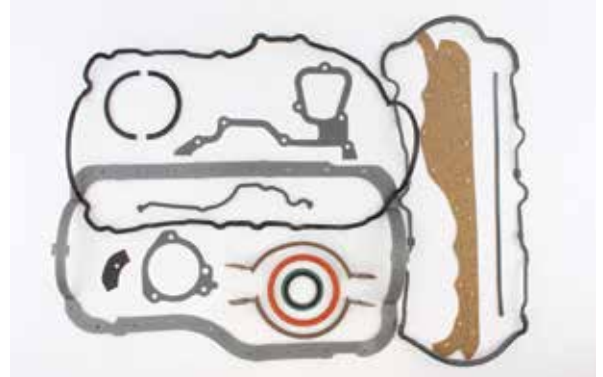

Application	Part #	List Price
2300 2.3L 1974-97	PRO2031B	\$221.52

2.0L 2012-15 EcoBoost DOHC:2013-2015 Ford Focus ST, 2011-2015 Ford Explorer

Head Gasket

MLS Head Gasket				
Bore	Thickness	Pkg Qty	Part #	List Price
89mm034"	1.....	C15317-034	\$102.16
89mm040"	1.....	C15317-040	\$102.16

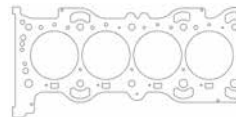

Additional thicknesses available see page 5

2.3L EcoBoost DOHC: 2016-2018 Ford Focus RS

Head Gasket

MLX Head Gasket				
Bore	Thickness	Pkg Qty	Part #	List Price
89mm040"	1.....	C15294-040	\$120.47

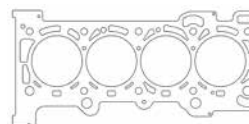

Additional thicknesses available see page 5

Individual Gaskets

Valve Cover Gasket		
Application	Part #	List Price
Valve Cover Gasket	C15445	\$36.50



FORD

2.0L 2003-11 & 2.3L 2003-08 Duratec/Mazda MZR DOHC

Head Gaskets

MLS Head Gasket

Bore	Thickness	Pkg Qty	Part #	List Price
89.5mm	.018"	1	C5843-018	\$102.16
92mm	.018"	1	C5842-018	\$102.16

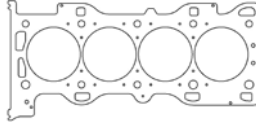

Additional thicknesses available
see page 5

Individual Gaskets

Intake Gasket Set

Application	Part #	List Price
2.3L Duratec 2003-08	C4842-060	\$19.05

Exhaust Manifold Gaskets

Application	Part #	List Price
2.3L Duratec (w/ extra port)	C4840-064	\$25.52
2.3L Duratec (w/o extra port)	C4841-064	\$25.52

2.7L EcoBoost

Head Gaskets

MLX Head Gasket - Right Side

Bore	Thickness	Pkg Qty	Part #	List Price
85.6mm	.036"	1	C15447-036	\$88.40

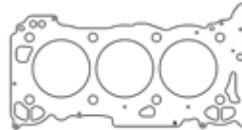

Additional thicknesses available
see page 5

MLX Head Gasket - Left Side

Bore	Thickness	Pkg Qty	Part #	List Price
85.6mm	.036"	1	C15448-036	\$88.40

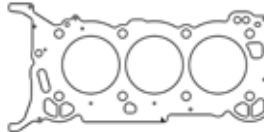

3.5L Cyclone Duratec V6 2010-Present

Head Gaskets

MLX Head Gasket - Right Side

Bore	Thickness	Pkg Qty	Part #	List Price
92.5mm	.040"	1	C5452-040	\$101.90

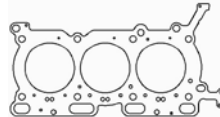

Additional thicknesses available
see page 5

MLX Head Gasket - Left Side

Bore	Thickness	Pkg Qty	Part #	List Price
92.5mm	.040"	1	C5453-040	\$101.90

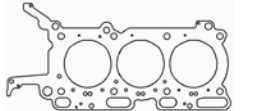

3.5L Cyclone EcoBoost V6 First Gen 2011-2016

Head Gaskets

MLS Head Gasket - Right Side

Bore	Thickness	Pkg Qty	Part #	List Price
95mm	.047"	1	C15554-047	\$101.90

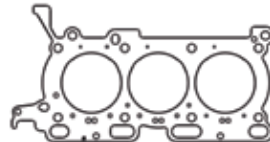

Additional thicknesses available
see page 5

MLS Head Gasket - Left Side

Bore	Thickness	Pkg Qty	Part #	List Price
95mm	.047"	1	C15555-047	\$101.90

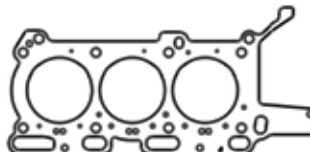



FORD

3.5L Cyclone EcoBoost V6 (D35 Second Gen) 2017+ 150 SVT Raptor, Lincoln Navigator

Head Gaskets

MLS Head Gasket - Right Side

Bore	Thickness	Pkg Qty	Part #	List Price
95mm	.040"	1	C15463-040	\$101.90
97.5mm	.040"	1	C15473-040	\$101.90

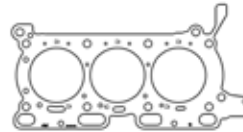

Additional thicknesses available
see page 5

MLS Head Gasket - Left Side

Bore	Thickness	Pkg Qty	Part #	List Price
95mm	.040"	1	C15464-040	\$101.90
97.5mm	.040"	1	C15474-040	\$101.90

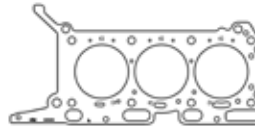

3.9L AJ30/AJ35 DOHC V8 2000-06

Head Gaskets

MLS Head Gasket - Right Side

Bore	Thickness	Pkg Qty	Part #	List Price
87mm	.030"	1	C5770-030	\$104.70
93mm	.030"	1	C5771-030	\$104.70

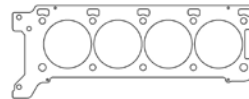

Additional thicknesses available
see page 5

MLS Head Gasket - Left Side

Bore	Thickness	Pkg Qty	Part #	List Price
87mm	.030"	1	C5772-030	\$104.70
93mm	.030"	1	C5773-030	\$104.70

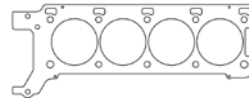

4.0L V6 1997-2010

MLX Head Gasket - Left Side

Bore	Thickness	Pkg Qty	Part #	List Price
103mm	.040"	1	C15382-040	\$100.57

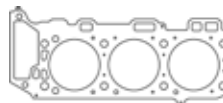

Additional thicknesses available
see page 5

MLX Head Gasket - Right Side

Bore	Thickness	Pkg Qty	Part #	List Price
103mm	.040"	1	C15381-040	\$100.57

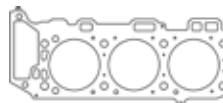

4.6L & 5.4L SOHC / DOHC Modular V8

Head Gaskets

MLS Head Gaskets - Left Side

Bore	Thickness	Pkg Qty	Part #	List Price
92mm	.030"	1	C5118-030	\$140.47
94mm	.030"	1	C5502-030	\$140.47

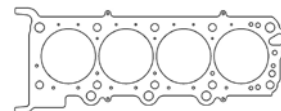

Additional thicknesses available
see page 5

MLS Head Gaskets - Right Side

Bore	Thickness	Pkg Qty	Part #	List Price
92mm	.030"	1	C5119-030	\$140.47
94mm	.030"	1	C5503-030	\$140.47

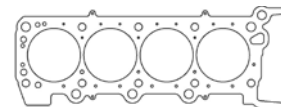

Individual Gaskets

Valve Cover Gasket Sets

Application	Part #	List Price
4.6L DOHC 1996-98	C5177	\$70.69
4.6L SOHC 1996-04	C5178	\$47.12
4.6L SOHC 2002-04 Truck	C5179	\$47.12

Throttle Body Gaskets

Application	Part #	List Price
SOHC 1996-01 Spacer-TB	C15078	\$3.54
DOHC 1996-98 .020" Fiber	C15079	\$5.30
SOHC 1996-00 Spacer-Manifold	C15080	\$12.06
4.6L SOHC 1999-11 - Rubber	C15081	\$7.38

See page 52 for additional gaskets



FORD

4.6L & 5.4L SOHC/DOHC Modular V8

Individual Gaskets

Intake Gaskets

Application	Part #	List Price
4.6L DOHC 1998	C5180	\$28.88
4.6L DOHC 1996-97	C5181	\$44.14
4.6L DOHC 1996-98 - Cover	C5182	\$51.99
4.6L DOHC 1996-98 - Plenum	C5183	\$55.71
4.6L SOHC 1995-00	C5184	\$34.52
4.6L SOHC 2000-04 Truck	C5185	\$46.09
4.6L SOHC 00-04 Truck Plenum	C5186	\$31.90
4.6L SOHC 97-99 Truck Plenum	C5187	\$29.40

Oil Pan Gasket

Application	Part #	List Price
4.6/5.4L 1996-04	C5188	\$38.05

Rear Main Seal

Application	Part #	List Price
4.6/5.4L 1996-04 - 1pc	C5189	\$18.49

Front Crank Seals

Application	Part #	List Price
4.6/5.4L SOHC/DOHC 1996-99	C5192	\$19.93
4.6/5.4L SOHC 2000-04	C5191	\$14.16

Water Pump O-Ring

Application	Part #	List Price
4.6/5.4L SOHC/DOHC 1992-09	C5190	\$4.87

Exhaust Gaskets

Application	Part #	List Price
4.6/5.4L SOHC 1991-01	C5853-030	\$37.62
4.6L DOHC 1993-99	C5012-030	\$41.39
5.4/5.8L Shelby GT500 2007-14	C5805-030	\$47.48

Gasket Kits



To purchase a complete gasket kit order both top end and bottom end gasket kit

TOP END GASKET KITS

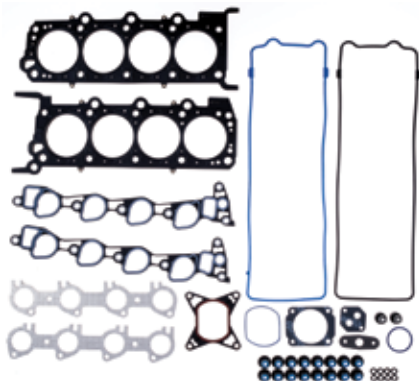

Application	Part #	List Price
4.6L DOHC 1996-98 92mm Bore	PRO1017T	\$428.47
4.6L SOHC 1996-98 92mm Bore	PRO1018T	\$274.22
4.6L SOHC 1999-04 92mm Bore	PRO1019T	\$241.98
4.6L SOHC 1997-04 Truck 92mm Bore	PRO1020T	\$274.22

BOTTOM END GASKET KITS

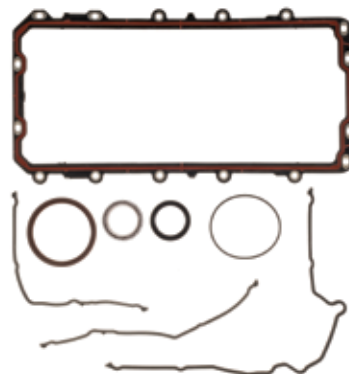

Application	Part #	List Price
4.6L DOHC 1996-98	PRO1017B	\$80.23
4.6L SOHC 1996-98	PRO1018B	\$91.69
4.6L SOHC 1999-04	PRO1019B	\$103.15
4.6L SOHC 1997-04 Truck	PRO1020B	\$165.84

4.6L SOHC 3v Heads Modular 2005-10

Head Gaskets

MLS Head Gasket - Left Side

Bore	Thickness	Pkg Qty	Part #	List Price
94mm	.030"	1	C5969-030	\$140.47
94mm	.040"	1	C5969-040	\$140.47

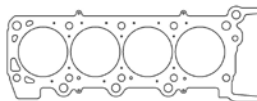

Additional thicknesses available see page 5

MLS Head Gasket - Right Side

Bore	Thickness	Pkg Qty	Part #	List Price
94mm	.030"	1	C5970-030	\$140.47
94mm	.040"	1	C5970-040	\$140.47

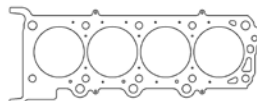

See page 53 for additional gaskets



FORD

4.6L SOHC 3v Heads Modular 2005-10

Head Gaskets

MLX Head Gasket - Left Side

Bore	Thickness	Pkg Qty	Part #	List Price
94mm	.032"	1	C15556-032	\$140.47
94mm	.040"	1	C15556-040	\$173.27
94mm	.052"	1	C15556-054	\$173.27

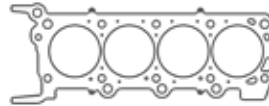

Additional thicknesses available
see page 5

MLX Head Gasket - Right Side

Bore	Thickness	Pkg Qty	Part #	List Price
94mm	.032"	1	C15557-032	\$140.47
94mm	.040"	1	C15557-040	\$173.27
94mm	.052"	1	C15557-054	\$173.27

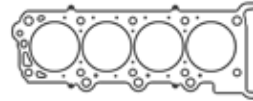

Individual Gaskets

Exhaust Gaskets

Application	Part #	List Price
4.6/5.4L 3V Heads - MLS D-Port	C5997-030	\$40.59
4.6/5.4L 3V Heads - MLS	C5852-030	\$40.59

5.4L SOHC 3v Heads Modular 2004-14

Head Gaskets

MLS Head Gasket - Left Side

Bore	Thickness	Pkg Qty	Part #	List Price
94mm	.030"	1	C5971-030	\$140.47

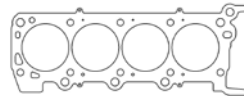

Additional thicknesses available
see page 5

MLS Head Gasket - Right Side

Bore	Thickness	Pkg Qty	Part #	List Price
94mm	.030"	1	C5972-030	\$140.47

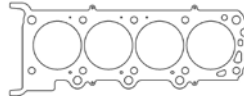

Individual Gaskets

Exhaust Gaskets

Application	Part #	List Price
4.6/5.4L 3V Heads - MLS D-Port	C5997-030	\$40.59
4.6/5.4L 3V Heads - MLS	C5852-030	\$40.59

5.0L Gen-1 "Coyote" DOHC Modular V8 2011-2014

Head Gaskets

MLS Head Gasket - Left Side

Bore	Thickness	Pkg Qty	Part #	List Price
94mm	.040"	1	C5287-040	\$140.47
94mm	.045"	1	C5287-045	\$140.47
94mm	.056"	1	C5287-056	\$173.27

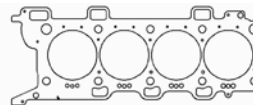

Additional thicknesses available
see page 5

MLS Head Gasket - Right Side

Bore	Thickness	Pkg Qty	Part #	List Price
94mm	.040"	1	C5286-040	\$140.47
94mm	.045"	1	C5286-045	\$140.47
94mm	.056"	1	C5286-056	\$173.27

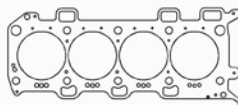

MLX Head Gasket - Left Side

Bore	Thickness	Pkg Qty	Part #	List Price
94mm	.040"	1	C15368-040	\$173.27

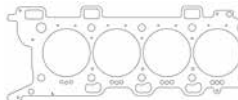

See page 54 for additional gaskets



FORD

5.0L Gen-1 "Coyote" DOHC Modular V8 2011-2014

Head Gaskets

MLX Head Gasket - Right Side

Bore	Thickness	Pkg Qty	Part #	List Price
94mm	.040"	1	C15367-040	\$173.27

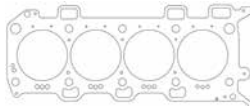

Individual Gaskets

Exhaust Gaskets

Application	Part #	List Price
5.0L DOHC Coyote - HTS	C5392HTS	\$32.95
5.0L DOHC Coyote - MLS	C5392-030	\$48.39

Intake Manifold Gasket Set

Application	Part #	List Price
2011-2014 5.0L	C15444	\$29.26

Valve Stem Seals (32 Pack)

Application	Part #	List Price
Hat Style - Viton Steel Body - INT/EXH	3268V-32	\$39.00

Timing Cover Set

Application	Part #	List Price
Ford 5.0L Coyote 2011-2020	C15493	\$88.39

Valve Cover Set

Application	Part #	List Price
Ford 5.0L 2011-2014	C15576	\$109.20

Gasket Kits



To purchase a complete gasket kit order both top end and bottom end gasket kit

NEW!

TOP END GASKET KITS

NEW!

BOTTOM END GASKET KITS

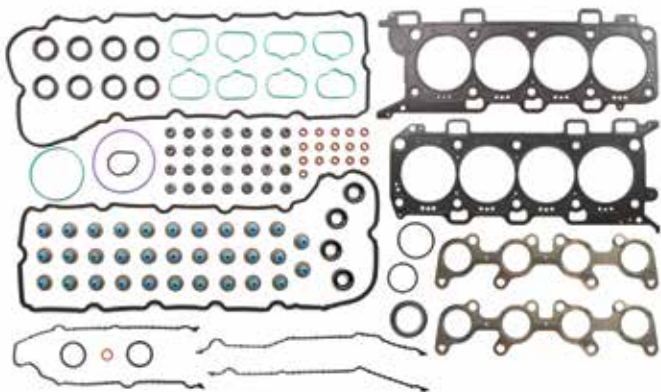

Application	Part #	List Price
2011-14 Ford 5.0L Gen-1 Coyote Modular V8	PRO1049T	\$410.80

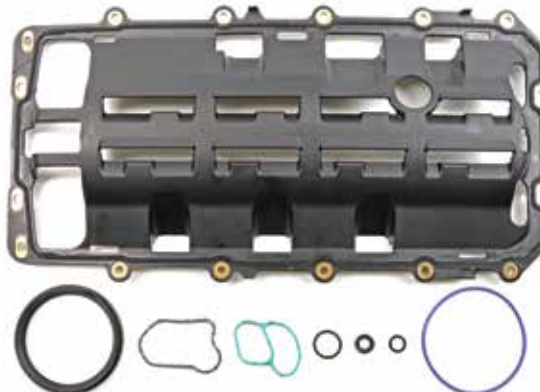

Application	Part #	List Price
2011-17 Ford 5.0L Gen-1/2 Coyote Modular V8	PRO1049B	\$163.28

5.0L Gen-2 "Coyote" DOHC Modular V8 2015-2017

Head Gaskets

MLS Head Gasket - Left Side

Bore	Thickness	Pkg Qty	Part #	List Price
94mm	.040"	1	C15370-040	\$140.47
94mm	.045"	1	C15370-045	\$140.47
94mm	.051"	1	C15370-051	\$140.47
94mm	.070"	1	C15370-070	\$173.17

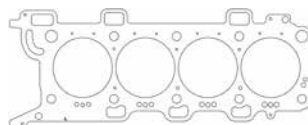

Additional thicknesses available see page 5

See page 55 for additional gaskets



FORD

5.0L Gen-2 "Coyote" DOHC Modular V8 2015-2017

Head Gaskets

MLS Head Gasket - Right Side

Bore	Thickness	Pkg Qty	Part #	List Price
94mm	.040"	1	C15369-040	\$140.47
94mm	.045"	1	C15369-045	\$140.47
94mm	.051"	1	C15369-051	\$140.47
94mm	.070"	1	C15369-070	\$173.27

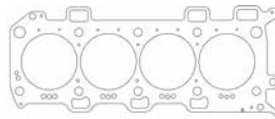

Additional thicknesses available
see page 5

MLX Head Gasket - Left Side

Bore	Thickness	Pkg Qty	Part #	List Price
94mm	.040"	1	C15366-040	\$173.27
94mm	.051"	1	C15366-051	\$173.27

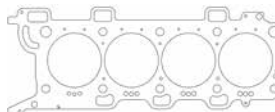

MLX Head Gasket - Right Side

Bore	Thickness	Pkg Qty	Part #	List Price
94mm	.040"	1	C15365-040	\$173.27
94mm	.051"	1	C15365-051	\$173.27

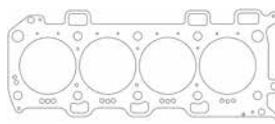

Individual Gaskets

Exhaust Gaskets

Application	Part #	List Price
5.0L DOHC Coyote - MLS	C5392-030	\$48.39

Valve Cover Gasket Set

Application	Part #	List Price
Ford 5.0L/5.2L 2014-2018	C15442	\$109.20

Intake Manifold Gasket Set

Application	Part #	List Price
Molded Rubber Intake Set of 8	C15465	\$25.99

Valve Stem Seals (32 Pack)

Application	Part #	List Price
Hat Style - Viton Steel Body - INT/EXH	3268V-32	\$39.00

Timing Cover Set

Application	Part #	List Price
Ford 5.0L Coyote 2011-2017	C15493	\$88.39

STREETpro
by Cometic Gasket

NEW!

BOTTOM END GASKET KITS



Application	Part #	List Price
2011-17 Ford 5.0L Gen-1/2 Coyote Modular V8	PRO1049B	\$163.28



FORD

5.0L Gen-3 "Coyote" DOHC Modular V8 2018+

Head Gaskets

MLS Head Gasket - Right Side

Bore	Thickness	Pkg Qty	Part #	List Price
94.5mm030"1	C15435-030\$140.47

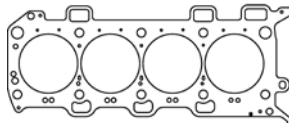

Additional thicknesses available
see page 5

MLS Head Gasket - Left Side

Bore	Thickness	Pkg Qty	Part #	List Price
94.5mm030"1	C15436-030\$140.47

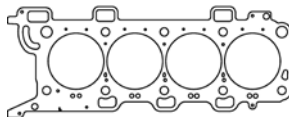

MLX Head Gasket - Right Side

Bore	Thickness	Pkg Qty	Part #	List Price
94.5mm040"1	C15548-040\$173.27

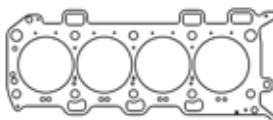

MLX Head Gasket - Left Side

Bore	Thickness	Pkg Qty	Part #	List Price
94.5mm040"1	C15549-040\$173.27

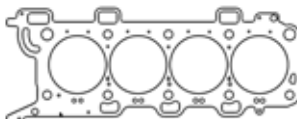

Individual Gaskets

Exhaust Gaskets

Application	Part #	List Price
5.0L DOHC Coyote - HTS	C5392HTS\$32.95
5.0L DOHC Coyote - MLS	C5392-030\$48.39

5.2L "Voodoo" DOHC Modular V8 2015-18

Head Gaskets

MLS Head Gasket - Left Side

Bore	Thickness	Pkg Qty	Part #	List Price
95mm036"1	C15388-036\$140.47
95mm040"1	C15388-040\$140.47

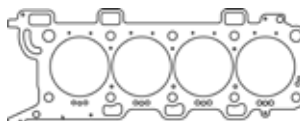

Additional thicknesses available
see page 5

MLS Head Gasket - Right Side

Bore	Thickness	Pkg Qty	Part #	List Price
95mm036"1	C15387-036\$140.47
95mm040"1	C15387-040\$140.47

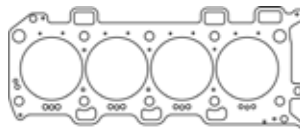

Individual Gaskets

Timing Cover Set

Application	Part #	List Price
Ford 5.0L Coyote 2011-2017;	C15493\$88.39
5.2L Voodoo 2015-2018		

Exhaust Gasket

Application	Part #	List Price
5.2L DOHC Voodoo - MLS 2015-2020	C15601-030\$48.39

Valve Cover Gasket Set

Application	Part #	List Price
Ford 5.2L 2015-2018	C15442\$109.20

Intake Gasket Set

Application	Part #	List Price
Molded Rubber Intake Set of 8	C15444\$29.26



FORD

5.8L "Trinity" DOHC Modular V8 2013-14

Head Gaskets

MLX Head Gasket - Left Side

Bore	Thickness	Pkg Qty	Part #	List Price
95.25mm051"1	C5017-051	\$173.27
95mm055"1	C5017-055	\$173.27

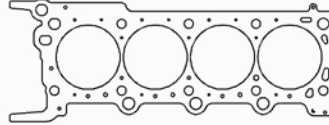

Additional thicknesses available
see page 5

MLX Head Gasket - Right Side

Bore	Thickness	Pkg Qty	Part #	List Price
95.25mm030"1	C5018-051	\$173.27
95mm055"1	C5018-055	\$173.27

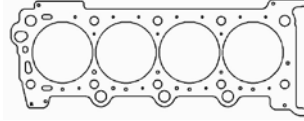

4.6/5.4L 2v/4v Modular V8 w/Darton Solid Sleeves

Head Gaskets

MLS Head Gasket - Left Side

Bore	Thickness	Pkg Qty	Part #	List Price
95.25mm040"1	C5856-040	\$140.47

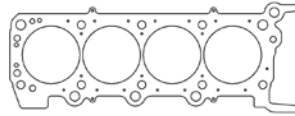

Additional thicknesses available
see page 5

MLS Head Gasket - Right Side

Bore	Thickness	Pkg Qty	Part #	List Price
95.25mm030"1	C5857-040	\$140.47

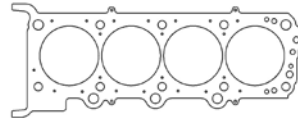

4.6/5.4L 2v/4v Modular V8 w/Darton M.I.D. Sleeves

Head Gaskets

MLS Head Gasket - Left Side

Bore	Thickness	Pkg Qty	Part #	List Price
95.25mm040"1	C5858-040	\$140.47

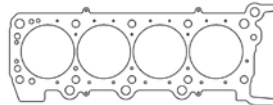

Additional thicknesses available
see page 5

MLS Head Gasket - Right Side

Bore	Thickness	Pkg Qty	Part #	List Price
95.25mm030"1	C5859-040	\$140.47

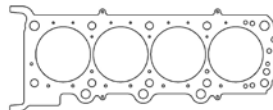

239, 256, 272, 292, 312 Y-Block V8 1956-64

Head Gasket

MLS Head Gasket - Right Side

Bore	Thickness	Pkg Qty	Part #	List Price
3.860"040"1	C15170-040	\$104.70

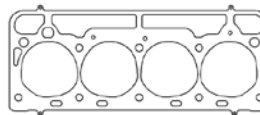

Additional thicknesses available
see page 5

MLS Head Gasket - Left Side

Bore	Thickness	Pkg Qty	Part #	List Price
3.860"040"1	C15171-040	\$104.70

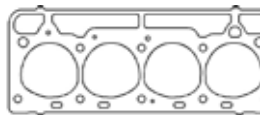

Individual Gaskets

Exhaust Gasket Set

Application	Part #	List Price
Y-Block 1956-64	C15082-064	\$32.95

Oil Pan Gasket

Application	Part #	List Price
Y-Block 1956-64	C15084	\$24.23

See page 58 for additional gaskets



FORD

239, 256, 272, 292, 312 Y-Block V8 1956-64

Individual Gaskets

Intake Gasket Set		
Application	Part #	List Price
Y-Block 1956-64	C15083	\$36.26

Timing Cover Gasket		
Application	Part #	List Price
Y-Block 1956-64	C15085	\$14.28

Valve Cover Gasket (sold individually)		
Application	Part #	List Price
Y-Block 1956-64	C15086	\$26.77

Water Pump O-Ring		
Application	Part #	List Price
Y-Block 1956-64	C15087	\$16.98

Gasket Kits



To purchase a complete gasket kit order both top end and bottom end gasket kit

TOP END GASKET KIT



Application	Part #	List Price
239-312 Y-Block 1956-64 3.860" Bore	PRO1039T	\$284.93

BOTTOM END GASKET KIT



Application	Part #	List Price
239-312 Y-Block 1956-64	PRO1039B	\$144.40

Windsor Small Block V8 SVO & non-SVO 1962-00

Head Gaskets

MLS Head Gaskets - SVO Round Bore				
Bore	Thickness	Pkg Qty	Part #	List Price
4.030"	.040"	1	C5478-040	\$93.07
4.060"	.040"	1	C5479-040	\$93.07
4.080"	.040"	1	C5480-040	\$93.07
4.100"	.040"	1	C5481-040	\$93.07
4.155"	.040"	1	C5483-040	\$93.07
4.195"	.051"	1	C5509-051	\$93.07
4.200"	.040"	1	C5485-040	\$93.07

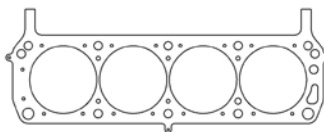

Additional thicknesses available see page 5

NEW!

MLX Head Gasket - SVO Round Bore				
Bore	Thickness	Pkg Qty	Part #	List Price
4.100"	.040"	1	C15372-040	\$119.67
4.170"	.040"	1	C15639-040	\$119.67
4.200"	.040"	1	C5757-040	\$119.67

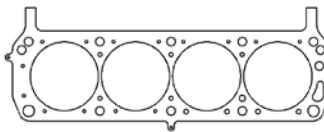

See page 59 for additional gaskets



FORD

Windsor Small Block V8 SVO & non-SVO 1962-00

Head Gaskets

MLS Head Gaskets - non SVO Round Bore				
Bore	Thickness	Pkg Qty	Part #	List Price
4.030"	.027"	1	C5511-027	\$93.07
4.030"	.040"	1	C5511-040	\$93.07
4.060"	.040"	1	C5512-040	\$93.07
4.080"	.040"	1	C5513-040	\$93.07
4.100"	.040"	1	C5514-040	\$93.07
4.155"	.040"	1	C5515-040	\$93.07
4.155"	.051"	1	C5515-051	\$93.07
4.200"	.040"	1	C5517-040	\$93.07

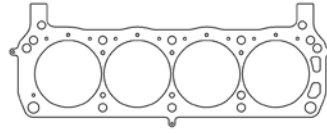

Additional thicknesses available see page 5

NEW! MLX Head Gasket - non-SVO Round Bore				
Bore	Thickness	Pkg Qty	Part #	List Price
4.100"	.040"	1	C15371-040	\$119.67
4.170"	.040"	1	C15640-040	\$119.67
4.200"	.040"	1	C5025-040	\$119.67

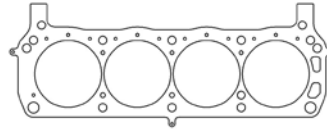

Individual Gaskets

Valve Cover Gasket (sold individually)		
Application	Part #	List Price
289/302/351-Molded Rubber	C5974	\$17.66
SVO, M6049 Heads .094" KF	C5659-094	\$12.77

Timing Cover Sets		
Application	Part #	List Price
260/289/302/351W 1962-78	C5064	\$25.92
302/351W 1979-97	C5065	\$25.92

Intake Manifold Gaskets		
Application	Part #	List Price
N351 2.120" x 1.280"	C5652-060	\$28.07
M6049 Yates 3C 2.00" x 1.35"	C5268-047	\$27.22
China Rail Gaskets	C5653-060	\$4.67

Oil Pan Gasket Sets		
Application	Part #	List Price
289/302 4pc Kit	C15091	\$34.48
351W 4pc Kit	C5279-094	\$34.48
351W 4pc Kit - For Stokers	C15092	\$34.48

Exhaust Manifold Gaskets		
Application	Part #	List Price
N351 1.585" x 1.681" .064" AM	C5655-064	\$25.52
351W 1.52" x 1.57" MLS	C15176-030	\$42.68
289/302 1.120" x 1.480" MLS	C5898-030	\$42.68
289/302 1.127" x 1.750" MLS	C5899-030	\$42.68
Yates 1.725" x 1.890" .064" AM	C5357-064	\$37.06
Yates MLS Ind Ports (8 pcs)	C5665-040	\$40.09

Rear Main Seals		
Application	Part #	List Price
289/302 Viton 2pc 1968-82	C5688	\$29.35
351W Viton 2pc 1969-83	C5689	\$31.11
289/302 1pc 1983-01	C5189	\$18.49
351W 1pc 1983-01	C15090	\$16.62
351W w/302 Crank	C5384	\$101.76

Carb/Throttle Body Gaskets		
Application	Part #	List Price
Holley 4bbl Open Plenum Carb	C5263	\$5.96
5.0L 1986-93 TB Gasket	C15099	\$6.32
5.0/5.8L 85-97 Truck TB Gasket	C15100	\$3.54
3.8/5.0L 89-95 TB Gasket	C15101	\$3.54

Water Pump Gaskets		
Application	Part #	List Price
289/302/351W 67-91 WP Gasket	C5662-060	\$9.33
302/351W 69-85 Cover Plate	C5353	\$10.18
289/302 63-65.5 Plate to Block	C15093	\$10.88
289/302/351W 63-69 Pump to Plate	C15094	\$10.88
351W 80-87 Water Pump Plate	C15095	\$8.96
302/351W 86-97 Pump to Plate	C15096	\$8.96
351W 88-95 Pump to Block	C15097	\$8.96
302 91-01 Plate to Block Gasket	C15098	\$8.96

Fuel Pump Gasket		
Application	Part #	List Price
Small Block Ford	C5389-060	\$1.86

See page 60 for StreetPro gasket kits



FORD

Windsor Small Block V8 SVO & non-SVO 1962-00

Gasket Kits



To purchase a complete gasket kit order both top end and bottom end gasket kit

TOP END GASKET KITS

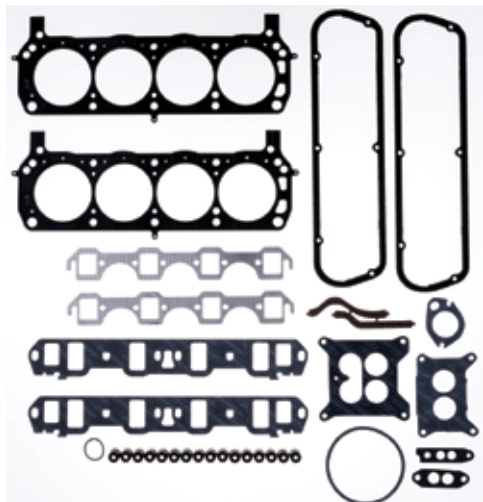

Application	Part #	List Price
289ci 65-68 & 302ci 68-85 4.100" Bore.....	PRO1015T	\$246.37
302ci EFI 86-95 4.100" Bore	PRO1016T	\$289.21
351ci Windsor 69-87 4.100" Bore.....	PRO1013T	\$289.21
351ci Windsor EFI 88-95 4.100" Bore	PRO1014T	\$284.93

BOTTOM END GASKET KITS



Application	Part #	List Price
289/302ci 65-95.....	PRO1015B	\$80.23
351ci Windsor 69-95.....	PRO1013B	\$114.61

Small Block Ford V8 - Aftermarket & Race

Head Gaskets

MLS Head Gaskets-SVO Yates w/Valve Pockets-LHS

Bore	Thickness	Pkg Qty	Part #	List Price
4.100"	.040"	1	C5358-040	\$93.07
4.180"	.040"	1	C5364-040	\$93.07
4.200"	.040"	1	C5366-040	\$93.07

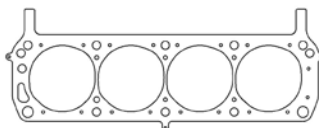

Additional thicknesses available see page 5

MLS Head Gaskets-SVO Yates w/Valve Pockets-RHS

Bore	Thickness	Pkg Qty	Part #	List Price
4.100"	.040"	1	C5359-040	\$93.07
4.180"	.040"	1	C5365-040	\$93.07
4.200"	.040"	1	C5367-040	\$93.07

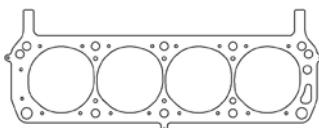

NEW!

MLS Head Gasket-SVO/Yates w/Valve Pockets

Bore	Thickness	Pkg Qty	Part #	List Price
4.210"	.040"	1	C15622-040	\$93.07

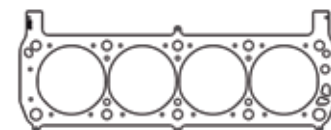

NEW!

MLS Head Gasket-SVO/Yates w/Valve Pockets All Active Layers

Bore	Thickness	Pkg Qty	Part #	List Price
4.210"	.041"	1	C15624-041	\$93.07

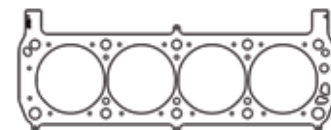

See page 61 for StreetPro gasket kits



FORD

Small Block Ford V8 - Aftermarket & Race

Head Gaskets

Additional thicknesses available
see page 5

MLS Head Gaskets - Brodix Track 1, Edelbrock RPM Performer, AFR Heads w/Coolant Channels

Bore	Thickness	Pkg Qty	Part #	List Price
4.030"	.040"	1	C5909-040	\$102.16
4.080"	.040"	1	C5910-040	\$102.16
4.100"	.040"	1	C5911-040	\$102.16
4.155"	.040"	1	C5912-040	\$102.16
4.200"	.040"	1	C5913-040	\$102.16

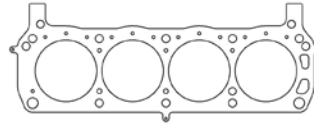

MLS Head Gaskets - New Boss 302 Blocks (will not work with OEM non-SVO heads)

Bore	Thickness	Pkg Qty	Part #	List Price
4.030"	.040"	1	C5958-040	\$93.07
4.080"	.040"	1	C5959-040	\$93.07
4.100"	.040"	1	C5960-040	\$93.07
4.155"	.040"	1	C5961-040	\$93.07
4.200"	.040"	1	C5962-040	\$93.07

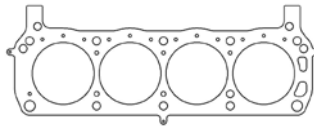

MLX Head Gaskets - New Boss 302 Blocks M6010-BOSS302 (will not work with OEM non-SVO heads)

Bore	Thickness	Pkg Qty	Part #	List Price
4.200"	.040"	1	C15373-040	\$119.67

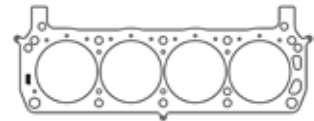

MLS Head Gasket - Right Side 302/351W '62-'01 SVO Heads with valve pocket

Bore	Thickness	Pkg Qty	Part #	List Price
4.150"	.040"	1	C15551-040	\$93.07

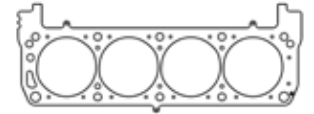

MLS Head Gasket - Left Side 302/351W '62-'01 SVO Heads with valve pocket

Bore	Thickness	Pkg Qty	Part #	List Price
4.150"	.040"	1	C15552-040	\$93.07

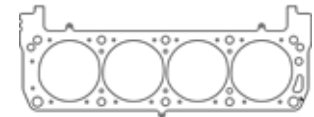

MLS Head Gasket - World Products Man O'War/Dart Iron Eagle, 10 Degree Heads-6 Bolts per Cylinder

Bore	Thickness	Pkg Qty	Part #	List Price
4.080"	.040"	1	C5132-040	\$102.16
4.100"	.040"	1	C5133-040	\$102.16
4.155"	.040"	1	C5134-040	\$102.16
4.180"	.040"	1	C5135-040	\$102.16

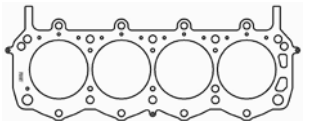

MLS Head Gasket-Brodix ASCS Head/R452 Block

Bore	Thickness	Pkg Qty	Part #	List Price
4.125"	.040"	1	C5217-040	\$93.07

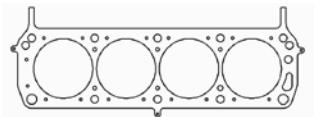



FORD

351 Cleveland, 351 Modified, & 400ci V8

Head Gasket

MLS Head Gasket

Bore	Thickness	Pkg Qty	Part #	List Price
4.100"	.040"	1	C5871-040	\$93.07

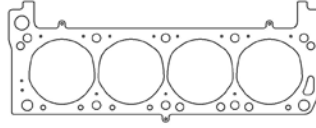

Additional thicknesses available
see page 5

Individual Gaskets

Valve Cover Gasket (sold individually)

Application	Part #	List Price
351C/351M/400 .125" KF	C5659-125	\$25.52

Oil Pan Gasket Set

Application	Part #	List Price
351C/351M/400 1970-81	C5278-094	\$34.48

Intake Manifold Gaskets

Application	Part #	List Price
351C/351M/400 4bbl Heads	C15102	\$35.89
351C/351M/400 2bbl Heads	C15103	\$35.89

Water Pump Gaskets

Application	Part #	List Price
Backing Plate Gasket	C5353	\$10.18
Water Pump Gasket w/Cast Iron Pump	C5662-060	\$9.33

Exhaust Manifold Gasket

Application	Part #	List Price
351C/351M/400 4bbl Heads	C15104	\$37.12

Timing Cover Set

Application	Part #	List Price
351C/351M/400 1970-81	C5066	\$23.56

Fuel Pump Gasket

Application	Part #	List Price
351C/351M/400 .031" Fiber	C15105	\$2.36

Rear Main Seals

Application	Part #	List Price
351C/351M/400 - 2pc Poly	C5088	\$9.86
351C/351M/400 - 2pc Viton	C5689	\$31.11

Ford RY45 V8

Head Gaskets

MLX Head Gaskets - Right Side

Bore	Thickness	Pkg Qty	Part #	List Price
4.290"	.040"	1	C15338-040	\$120.47

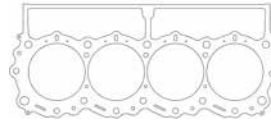

Additional thicknesses available
see page 5

MLX Head Gaskets - Left Side

Bore	Thickness	Pkg Qty	Part #	List Price
4.290"	.040"	1	C15337-040	\$120.47

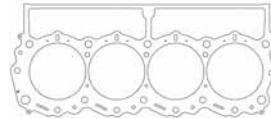

Ford FR9 Race V8

Head Gaskets

MLX Head Gaskets - Right Side

Bore	Thickness	Pkg Qty	Part #	List Price
4.190"	.040"	1	C5587-040	\$120.47

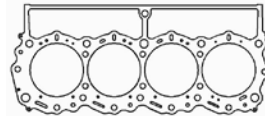

Additional thicknesses available
see page 5

MLX Head Gaskets - Left Side

Bore	Thickness	Pkg Qty	Part #	List Price
4.190"	.040"	1	C5588-040	\$120.47

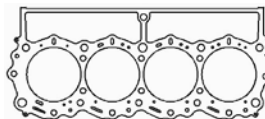

Individual Gaskets

Intake Manifold Gaskets

Application	Part #	List Price
FR9 V8 - 2.05" x 1.39" .060" KF	C15106-060	\$34.52

Exhaust Manifold Gaskets

Application	Part #	List Price
FR9 V8 - .030" MLS	C15107-030	\$60.72



FORD

Ford Flathead V8 1932-53

Head Gaskets

MLS Head Gasket - 1932-38 21 Bolt				
Bore	Thickness	Pkg Qty	Part #	List Price
3.156"	.040"	1	C5870-040	\$152.39

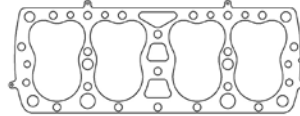

Additional thicknesses available
see page 5

MLS Head Gasket - 1938-48 24 Bolt				
Bore	Thickness	Pkg Qty	Part #	List Price
3.250"	.051"	1	C5908-051	\$152.39
3.375"	.051"	1	C5108-051	\$152.39

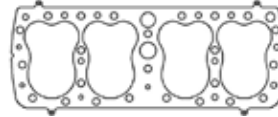

MLS Head Gasket - 1949-53 24 Bolt - RHS				
Bore	Thickness	Pkg Qty	Part #	List Price
3.375"	.051"	1	C15088-051	\$152.39
3.375"	.092"	1	C15088-092	\$198.04

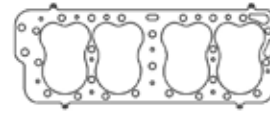

MLS Head Gasket - 1949-53 24 Bolt - LHS				
Bore	Thickness	Pkg Qty	Part #	List Price
3.375"	.051"	1	C15089-051	\$152.39
3.375"	.092"	1	C15089-092	\$198.04

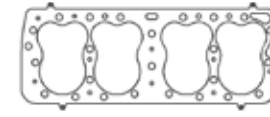

Individual Gaskets

Carburetor Gaskets (sold individually)		
Application	Part #	List Price
Holley Air Cleaner Gasket	C15108	\$3.09
59A, 8BA, 8CM 2bbl Gasket	C15109	\$3.52

Timing Cover Gaskets		
Application	Part #	List Price
59A 1945-48 .015" Fiber	C15134	\$6.48
8BA/8CM 1948-53 .015" Fiber	C15135	\$6.48

Intake Manifold Gaskets		
Application	Part #	List Price
59A 1945-48 .060" KF	C15120	\$35.82
8BA/8CM 1948-53 .060" KF	C15121	\$35.82

Water Pump Gaskets		
Application	Part #	List Price
59A 1945-48 .015" Fiber	C15136	\$5.14
8BA/8CM 1948-53 .015" Fiber	C15137	\$6.48

Exhaust Manifold Gaskets		
Application	Part #	List Price
59A, 8BA, 8CM 1945-53 8PK	C15116	\$43.25

Fuel Pump Gaskets		
Application	Part #	List Price
59A 45-48 Fuel Pump Stand	C15117	\$1.89
59A 46-53 Fuel Pump Cover	C15118	\$1.35
8BA/8CM 48-53 Fuel Pump Mount	C15119	\$1.35

Distributor Gaskets		
Application	Part #	List Price
59A 45-48 Distributor Base	C15110	\$4.06
59A 45-48 Distributor Cap Cover	C15111	\$2.97
59A Distributor Terminal Housing	C15112	\$2.71
59A 32-41 Distributor Base	C15113	\$4.06
59A 32-41 Distributor Cap Cover	C15114	\$2.71
59A Distributor Coil Base	C15115	\$2.97

Oil Pump/Pan Gaskets		
Application	Part #	List Price
59A 32-41 Oil Pump Drive Cover	C15122	\$3.80
59A 45-48 Oil Pump Drive Cover	C15123	\$3.80
59A 45-48 Oil Pump Mounting	C15126	\$1.08
59A 45-48 Oil Pump Screen Cover	C15127	\$1.08
8BA/8CM 48-53 Oil Pump Drive Cover	C15130	\$4.33
8BA/8CM 48-53 Oil Pump Relief Nut	C15132	\$1.08
59A 45-48 Drain Plug Gasket	C15124	\$1.63
59A 1938 Drain Plug Gasket	C15125	\$1.08
8BA/8CM 48-53 Drain Plug Gasket	C15133	\$1.08
8BA/8CM Oil Pan Clean Out	C15128	\$6.75
8BA/8CM Oil Pan Gasket	C15129	\$17.30
8BA/8CM Dipstick Tube Gasket	C15131	\$1.35



FORD

352, 390, 406, 410, 427, & 428 FE V8

Head Gaskets

MLS Head Gaskets - Top Oiler

Bore	Thickness	Pkg Qty	Part #	List Price
4.080"	.040"	1	C5833-040	\$104.70
4.165"	.040"	1	C5834-040	\$104.70
4.250"	.040"	1	C5835-040	\$104.70
4.300"	.040"	1	C5523-040	\$104.70
4.400"	.040"	1	C5840-040	\$104.70

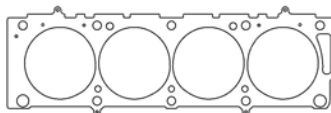

Additional thicknesses available see page 5

MLS Head Gasket - SOHC Side Oiler

Bore	Thickness	Pkg Qty	Part #	List Price
4.400"	.040"	1	C5841-040	\$104.70

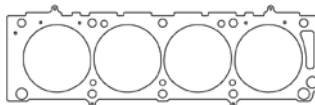

Individual Gaskets

Valve Cover Gaskets (sold individually)

Application	Part #	List Price
All FE & 428CJ/SCJ	C5138-188	\$23.44
427 SOHC LHS	C15138-188	\$24.69
427 SOHC RHS	C15139-188	\$24.69

Timing Cover Sets

Application	Part #	List Price
352/360 1958-60	C5067	\$23.56
332-428 1961-71	C5068	\$23.56

Intake Manifold Gaskets

Application	Part #	List Price
STD/Low Riser 428CJ/SCJ	C5137-060	\$32.04
427 SOHC	C15140-060	\$35.33

Oil Pan Gasket

Application	Part #	List Price
FE V8 1961-71	C5141-125	\$24.23

Exhaust Manifold Gaskets

Application	Part #	List Price
352-410 FE & 428CJ/SCJ MLS	C5922-030	\$49.50
427 SOHC .064" AM	C15141-064	\$25.52

Rear Main Seal

Application	Part #	List Price
FE V8 1961-71	C5142	\$26.66

Water Pump Gaskets

Application	Part #	List Price
FE V8 1961-71 (Pair)	C5140-031	\$4.13

Gasket Kits



To purchase a complete gasket kit order both top end and bottom end gasket kit

TOP END GASKET KIT



Application	Part #	List Price
352, 390, 410, 428 FE V8 4.300" Bore	PRO1027T	\$188.52

BOTTOM END GASKET KIT



Application	Part #	List Price
352, 390, 410, 428 FE V8	PRO1027B	\$64.18



FORD

429ci 7.0L & 460ci 7.5L Big Block V8

Head Gaskets

MLS Head Gaskets

Bore	Thickness	Pkg Qty	Part #	List Price
4.400"	.040"	1	C5666-040	\$102.16
4.440"	.040"	1	C15400-040	\$102.16
4.500"	.040"	1	C5667-040	\$102.16
4.600"	.040"	1	C15142-040	\$102.16
4.670"	.040"	1	C5668-040	\$102.16

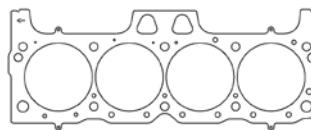

Additional thicknesses available
see page 5

Copper Head Gaskets

Bore	Thickness	Pkg Qty	Part #	List Price
4.520"	.043"	1	C15421-043	\$130.31

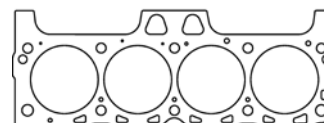

Individual Gaskets

Valve Cover Gaskets (sold individually)

Application	Part #	List Price
429/460 Big Block Molded Rubber	C15467	\$32.91
429/460 Big Block .125" KF	C5205-125	\$21.69

Timing Cover Set

Application	Part #	List Price
429/460 1968-85	C5069	\$23.56

Intake Manifold Gaskets

Application	Part #	List Price
Stock 429/460 Heads	C5043-060	\$35.33
CJ/SCJ 2.24" x 2.60" Port	C5206-060	\$33.63

Oil Pan Gasket

Application	Part #	List Price
429/460 4 pc set	C5125-094	\$41.05

Exhaust Manifold Gaskets

Application	Part #	List Price
429/460 Oval Port - .030" MLS	C5900-030	\$47.17

Rear Main Seal

Application	Part #	List Price
429/460 Big Block 2pc	C5208	\$16.63

Water Pump Gaskets

Application	Part #	List Price
429/460 Big Block	C5209-031	\$13.25

Gasket Kits



To purchase a complete gasket kit order both top end and bottom end gasket kit

TOP END GASKET KIT



Application	Part #	List Price
429/460ci Big Block V8 68-78 4.500" Bore	PRO1012T	\$242.08

BOTTOM END GASKET KIT

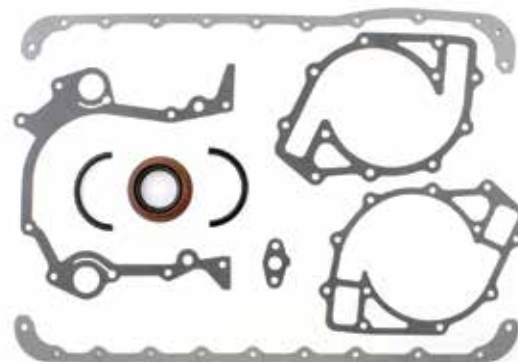

Application	Part #	List Price
429/460ci Big Block V8 68-78	PRO1012B	\$69.91



FORD

Pro Stock Racing V8

Head Gaskets

MLS Head Gasket - D/E460 PRO STOCK				
Bore	Thickness	Pkg Qty	Part #	List Price
4.600"	.045"	1	C5731-045	\$135.35
4.685"	.045"	1	C5732-045	\$135.35

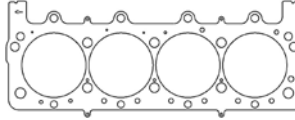

Additional thicknesses available
see page 5

MLS Head Gaskets - A460/C460 PRO STOCK				
Bore	Thickness	Pkg Qty	Part #	List Price
4.500"	.045"	1	C15446-045	\$135.35
4.600"	.045"	1	C5743-045	\$135.35
4.685"	.045"	1	C5744-045	\$135.35

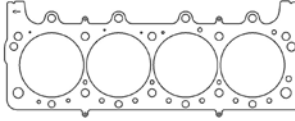

MLS Head Gaskets- A500 PRO STOCK - LHS				
Bore	Thickness	Pkg Qty	Part #	List Price
4.600"	.045"	1	C5727-045	\$135.35
4.685"	.045"	1	C5729-045	\$135.35

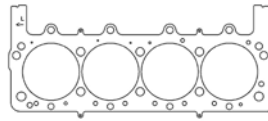

MLS Head Gaskets - A500 PRO STOCK - RHS				
Bore	Thickness	Pkg Qty	Part #	List Price
4.600"	.045"	1	C5728-045	\$135.35
4.685"	.045"	1	C5730-045	\$135.35

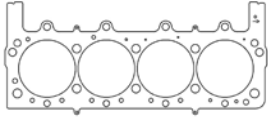

MLS Head Gasket - 460 w/Hemi 14 Bolt Head				
Bore	Thickness	Pkg Qty	Part #	List Price
4.700"	.040"	1	C5888-040	\$135.35

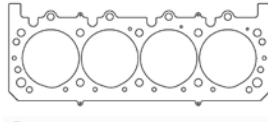

MLS Head Gasket - JC50 500ci PRO STOCK - LHS				
Bore	Thickness	Pkg Qty	Part #	List Price
4.735"	.052"	1	C5284-052	\$167.62

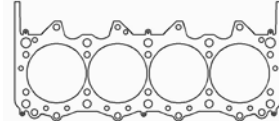

MLS Head Gasket - JC50 500ci PRO STOCK - RHS				
Bore	Thickness	Pkg Qty	Part #	List Price
4.735"	.052"	1	C5285-052	\$167.62

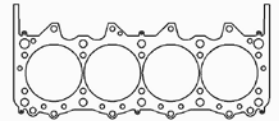

MLS Head Gaskets - 800ci W/5.0" Bore Centers				
Bore	Thickness	Pkg Qty	Part #	List Price
4.770"	.040"	1	C5875-040	\$102.16
4.770"	.051"	1	C5875-051	\$102.16

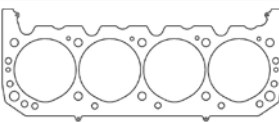

Individual Gaskets

Exhaust Manifold Gaskets		
Application	Part #	List Price
JC50 500ci - .030" MLS	C5257-030	\$60.72

6.2L SOHC Raptor 2010-13

Head Gasket

MLX Head Gasket				
Bore	Thickness	Pkg Qty	Part #	List Price
4.125"	0.054	1	C15430-054	\$173.27

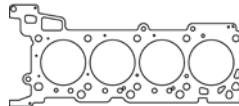

Additional thicknesses available
see page 5

MLX Head Gasket				
Bore	Thickness	Pkg Qty	Part #	List Price
4.125"	0.054	1	C15429-054	\$173.27

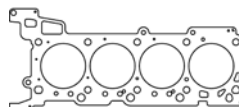



FORD

6.8L Modular V10

MLX Head Gaskets - Right Side				
Bore	Thickness	Pkg Qty	Part #	List Price
92.5mm	.040"	1	C15462-040	\$120.47

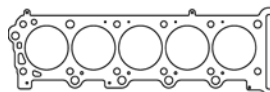

Additional thicknesses available
see page 5

MLX Head Gaskets - Left Side				
Bore	Thickness	Pkg Qty	Part #	List Price
92.5mm	.040"	1	C15461-040	\$120.47

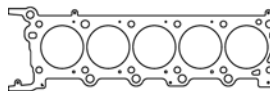

6.0L Power Stroke Diesel 2003-08

Head Gaskets

MLX Head Gasket - 2003-06 18mm Dowels				
Bore	Thickness	Pkg Qty	Part #	List Price
96mm	.062"	1	C5589-062	\$158.39

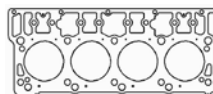

Additional thicknesses available
see page 5

MLX Head Gasket - 2007-08 20mm Dowels				
Bore	Thickness	Pkg Qty	Part #	List Price
96mm	.062"	1	C5984-062	\$158.39

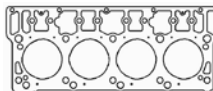

Individual Gaskets

Valve Cover Gasket Set		
Application	Part #	List Price
6.0L Power Stroke 03-08	C15143	\$23.56

Valve Stem Seals (sold individually)		
Application	Part #	List Price
6.0L Power Stroke 03-08 (Req 32)	3217V	\$4.26

Intake Manifold Gasket Set		
Application	Part #	List Price
6.0L Power Stroke 03-08	C15144	\$108.33

HPOP Cover Gasket		
Application	Part #	List Price
6.0L Power Stroke 03-08	C15145	\$28.05

Exhaust Manifold Gasket		
Application	Part #	List Price
6.0L Power Stroke 03-08 - MLS	C5089-030	\$51.73

Oil Cooler O-Ring Kit		
Application	Part #	List Price
6.0L Power Stroke 03-08	C15146	\$132.68

Throttle Body Gasket		
Application	Part #	List Price
6.0L Power Stroke 03-08	C15153	\$7.99

Cylinder Head Dowels (sold individually)		
Application	Part #	List Price
6.0L Power Stroke 03-06 18mm	C15147	\$4.07
6.0L Power Stroke 07-08 20mm	C15148	\$7.97

Gasket Kits



To purchase a complete gasket kit order both top end and bottom end gasket kit

TOP END GASKET KITS



Application	Part #	List Price
6.0L Power Stroke 03-06	PRO3005T	\$819.88
6.0L Power Stroke 07-08	PRO3006T	\$819.88

BOTTOM END GASKET KIT



Application	Part #	List Price
6.0L Power Stroke 03-08	PRO3005B	\$152.57



FORD

6.4L Power Stroke Diesel 2008-2010

Head Gasket

MLX Head Gasket				
Bore	Thickness	Pkg Qty	Part #	List Price
103mm062"1	C5610-062\$158.39
103mm067"1	C5610-067\$152.30

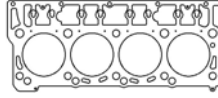

Additional thicknesses available
see page 5

MLX Head Gasket - REV B				
Bore	Thickness	Pkg Qty	Part #	List Price
103mm062"1	C15175-062\$158.39

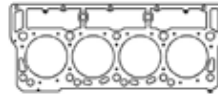

Individual Gaskets

Valve Cover Gasket Set		
Application	Part #	List Price
6.4L Power Stroke 08-10	C15151\$35.34

Turbo Mounting Kit		
Application	Part #	List Price
6.4L Power Stroke 08-10	C15154\$76.58

Intake Manifold Gasket Set		
Application	Part #	List Price
6.4L Power Stroke 08-10	C15152\$38.46

Fuel Injector Seal Kit		
Application	Part #	List Price
6.4L Power Stroke 08-10 (pack of 8)	C15155\$24.88

Exhaust Manifold Gasket		
Application	Part #	List Price
6.4L Power Stroke 08-10 - MLS	C5089-030\$51.73

Oil Cooler O-Ring Kit		
Application	Part #	List Price
6.4L Power Stroke 08-10	C15156\$65.62

Valve Stem Seals (sold individually)		
Application	Part #	List Price
6.4L Power Stroke 08-10 (Req 32)	3217V\$4.26

Cooling/Water Pump Gaskets		
Application	Part #	List Price
Thermostat Housing Seal	C15157\$5.97
Lower Coolant Hose Gasket	C15158\$6.75
Upper Coolant hose Gasket	C15159\$6.19

Throttle Body Gasket		
Application	Part #	List Price
6.0L Power Stroke 03-10	C15153\$7.99

Cylinder Head Dowels (sold each)		
Application	Part #	List Price
6.4L Power Stroke 08-10 20mm	C15148\$7.97

Gasket Kits



To purchase a complete gasket kit order both top end and bottom end gasket kit

TOP END GASKET KIT

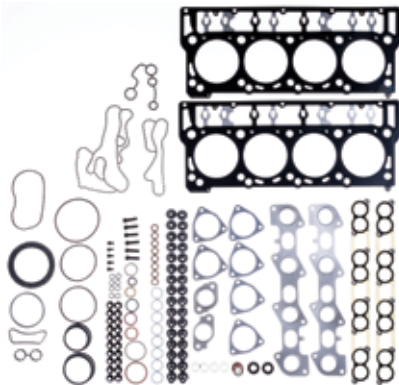

Application	Part #	List Price
6.4L Power Stroke 08-10 99mm Bore	PRO3007T\$819.88

BOTTOM END GASKET KIT

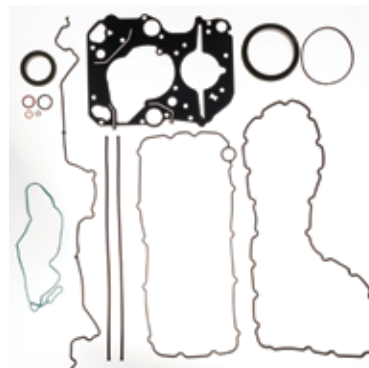

Application	Part #	List Price
6.4L Power Stroke 08-10	PRO3007B\$200.47

6.7L Power Stroke Scorpion Diesel 2011-17

Head Gaskets

MLX Head Gasket - RHS				
Bore	Thickness	Pkg Qty	Part #	List Price
100mm053"1	C15160-053\$158.39
100mm062"1	C15160-062\$158.39

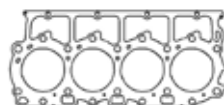

Additional thicknesses available
see page 5



FORD

6.7L Power Stroke Scorpion Diesel 2011-17

Head Gaskets

MLX Head Gasket - LHS

Bore	Thickness	Pkg Qty	Part #	List Price
100mm	.053"	1	C15161-053	\$158.39
100mm	.062"	1	C15161-062	\$158.39

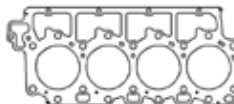

Additional thicknesses available see page 5

Individual Gaskets

Exhaust Manifold Gaskets

Application	Part #	List Price
6.7L Power Stroke Scorpion MLS	C15487-030	\$45.82

Oil Pan Gaskets

Application	Part #	List Price
.060" AFM Material	C15466-060	\$21.83

7.3L Power Stroke Diesel 1994-03

Head Gasket

MLS Head Gasket

Bore	Thickness	Pkg Qty	Part #	List Price
4.140"	.066"	1	C5839-066	\$158.39



Additional thicknesses available see page 5

MLX Head Gasket

Bore	Thickness	Pkg Qty	Part #	List Price
4.140"	.067"	1	C15390-067	\$158.39



Individual Gaskets

Valve Cover Gaskets (sold individually)

Application	Part #	List Price
7.3L Power Stroke 94-97	C15162	\$58.91
7.3L Power Stroke 98-03	C15163	\$82.47

HPOP Gaskets

Application	Part #	List Price
7.3L Power Stroke 94-95	C15164	\$18.87
7.3L Power Stroke 96-03	C15165	\$18.87

Intake Manifold Gasket Set

Application	Part #	List Price
7.3L Power Stroke .060" AFM	C5090-060	\$30.71

Valve Stem Seals (sold individually)

Application	Part #	List Price
7.3L Power Stroke (need 16)	3216V	\$3.91

Exhaust Manifold Gaskets

Application	Part #	List Price
7.3L Power Stroke .064" AM	C5091-064	\$38.33

Gasket Kits



To purchase a complete gasket kit order both top end and bottom end gasket kit

TOP END GASKET KIT

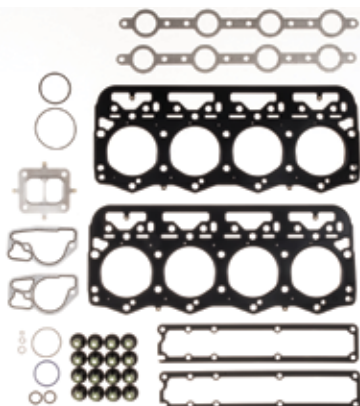

Application	Part #	List Price
7.3L Power Stroke 1994-03	PRO3010T	\$468.96

BOTTOM END GASKET KIT



Application	Part #	List Price
7.3L Power Stroke 1994-03	PRO3010B	\$174.86



OLDSMOBILE

330, 350, 400, 403, & 455ci V8

Head Gasket

MLS Head Gaskets

Bore	Thickness	Pkg Qty	Part #	List Price
4.125"	.040"	1	C5808-040	\$104.70
4.200"	.040"	1	C5809-040	\$104.70
4.270"	.040"	1	C5811-040	\$104.70
4.400"	.040"	1	C5810-040	\$104.70

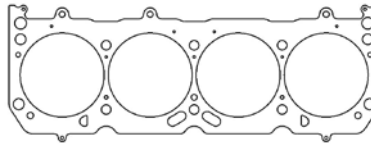

Additional thicknesses available see page 5

Individual Gaskets

Valve Cover Gasket (sold individually)

Application	Part #	List Price
330-455ci Olds V8 .188" Molded Rubber	C15440	\$23.56

Timing Cover Set

Application	Part #	List Price
330-455ci Olds V8 1964-90	C5070	\$23.56

Intake Manifold Gaskets

Application	Part #	List Price
330, 350, & 403 Small V8	C5216-030	\$28.07
400 & 455 Big V8	C5813-060	\$28.07

Water Pump Gaskets

Application	Part #	List Price
330-455ci V8 1968-76 w/AC	C15166	\$8.96
330-455ci V8 1964-90	C15167	\$8.96

Exhaust Manifold Gaskets

Application	Part #	List Price
330-455ci V8 Stock Port .064" AM	C5812-064	\$31.88
330-455ci V8 1.45"x1.92" MLS	C5904-030	\$46.05

Oil Pan Gasket Kit

Application	Part #	List Price
330-455ci Olds V8 4pc Kit	C5822-094	\$33.12

Gasket Kits



To purchase a complete gasket kit order both top end and bottom end gasket kit

TOP END GASKET KIT

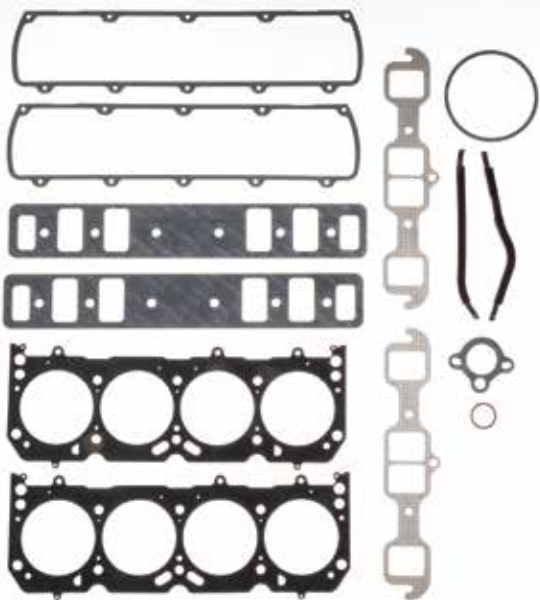

Application	Part #	List Price
Olds 455ci V8 1968-76 4.200" Bore	PRO1009T	\$209.94

BOTTOM END GASKET KIT



Application	Part #	List Price
Olds 455ci V8 1968-76	PRO1009B	\$64.18



OLDSMOBILE

370/371 J-2 Golden Rocket 1957-60

Head Gasket

MLS Head Gasket				
Bore	Thickness	Pkg Qty	Part #	List Price
4.190"	.040"	1	C5129-040	\$104.70

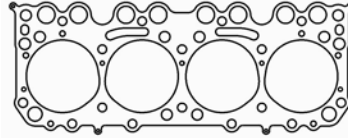

Additional thicknesses available see page 5

Individual Gaskets

Intake Manifold Gaskets		
Application	Part #	List Price
371 J-2 Golden Rocket .060" KF	C5130-060	\$38.91

Exhaust Manifold Gasket Set		
Application	Part #	List Price
371 J-2 Golden Rocket .059" CFM	C5131-059	\$31.55

PONTIAC

389 & 421ci V8

Head Gaskets

MLS Head Gaskets-389 (63-67) & 421 (63-66)				
Bore	Thickness	Pkg Qty	Part #	List Price
4.300"	.040"	1	C15262-040	\$104.70
4.300"	.060"	1	C15262-060	\$142.38
4.300"	.080"	1	C15262-080	\$153.89

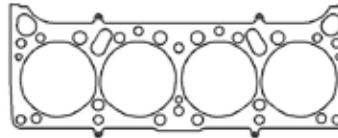

Additional thicknesses available see page 5

326, 350, 400, 428, & 455ci V8

Head Gaskets

MLS Head Gaskets-326 (63-67) & 350 (68-77)				
Bore	Thickness	Pkg Qty	Part #	List Price
3.750"	.040"	1	C5767-040	\$104.70
3.950"	.040"	1	C5710-040	\$104.70

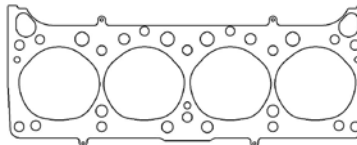

Additional thicknesses available see page 5

MLS Head Gaskets-400 (68-79), 428 (68-69), 455 (70-76)				
Bore	Thickness	Pkg Qty	Part #	List Price
4.160"	.040"	1	C5711-040	\$104.70
4.200"	.040"	1	C5769-040	\$104.70
4.300"	.040"	1	C5712-040	\$104.70
4.380"	.040"	1	C5846-040	\$104.70
4.400"	.040"	1	C5847-040	\$104.70

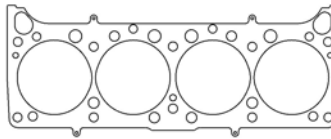

Individual Gaskets

Molded Rubber Valve Cover Gaskets (sold individually)		
Application	Part #	List Price
All Models w/Stock Heads	C5044	\$23.56

Timing Cover Set		
Application	Part #	List Price
265-455ci V8 193-81	C5071	\$29.44

Intake Manifold Gaskets		
Application	Part #	List Price
400, 428, & 455ci .060" KF	C5778-060	\$28.07
326-455ci .060" HTS w/o EGR	C15197-060	\$28.13

Oil Pan Gasket Kit		
Application	Part #	List Price
400, 428, & 455ci 4 pc kit	C5176-094	\$20.44

Exhaust Manifold Gaskets		
Application	Part #	List Price
400, 428, & 455ci .064" AM	C5147-064	\$25.51
400, 428, & 455ci D-Port MLS	C5905-030	\$46.05

Water Pump Gasket		
Application	Part #	List Price
400, 428, & 455ci .031" Fiber	C5149-031	\$11.19

See page 72 for StreetPro gasket kits



PONTIAC

326, 350, 400, 428, & 455ci V8

Gasket Kits



To purchase a complete gasket kit order both top end and bottom end gasket kit

TOP END GASKET KIT



Application	Part #	List Price
Big Block 455ci 7.5L 1970-76 4.200" Bore	PRO1010T	\$177.81

BOTTOM END GASKET KIT



Application	Part #	List Price
Big Block 455ci 7.5L 1970-76	PRO1010B	\$45.38

AUSTIN

1000cc 4 Cylinder 1958-65 Healey Sprite Mark I & II

Head Gasket

Copper Head Gasket

Bore	Thickness	Pkg Qty	Part #	List Price
67.5mm043"	1	C4145-043	\$86.65

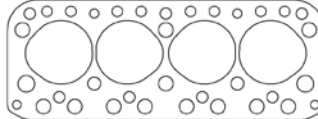

Additional thicknesses available
see page 5

1300cc 4 Cylinder Austin Mini

Head Gasket

MLS Head Gasket

Bore	Thickness	Pkg Qty	Part #	List Price
72mm030"	1	C14046-030	\$97.27
72.5mm030"	1	C14073-030	\$97.27
73mm030"	1	C4146-030	\$97.27
73.5mm030"	1	C14038-030	\$97.27

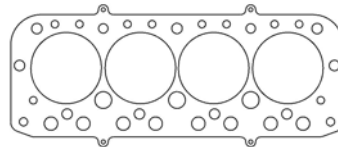

Additional thicknesses available
see page 5



BMW

M10 4 Cylinder

Head Gaskets

MLS Head Gasket - 1573/1773cc M116/M118 1963-77				
Bore	Thickness	Pkg Qty	Part #	List Price
86mm	.051"	1	C4292-051	\$153.22

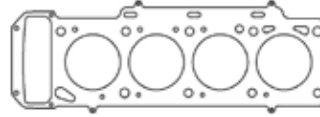

Additional thicknesses available see page 5

MLS Head Gasket - 1766/1990cc M10B18/M10B20 1975-88				
Bore	Thickness	Pkg Qty	Part #	List Price
90mm	.051"	1	C4293-051	\$153.22

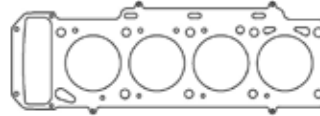

Individual Gaskets

Valve Cover Gasket		
Application	Part #	List Price
BMW M10B18/B20 .125" Cork	C4794-125	\$9.17

Oil Pan Gasket Kit		
Application	Part #	List Price
BMW M10B18/B20 .062" KF	C4796-062	\$30.09

Intake Manifold Gasket Set		
Application	Part #	List Price
BMW M10B18/B20 .060" KF	C4793	\$15.05

Rear Main Seal		
Application	Part #	List Price
BMW M10B18/B20	C4797	\$44.26

Exhaust Manifold Gasket Set		
Application	Part #	List Price
BMW M10B18/B20 .064" AM	C4883	\$14.67

Thermostat Gasket		
Application	Part #	List Price
BMW M10B18/B20 .031" Fiber	C4795-031	\$1.89

Gasket Kits



To purchase a complete gasket kit order both top end and bottom end gasket kit

TOP END GASKET KIT



Application	Part #	List Price
M10 1.8/2.0L 1966-88 90mm Bore	PRO2027T	\$221.52

BOTTOM END GASKET KIT



Application	Part #	List Price
M10 1.8/2.0L 1966-88	PRO2027B	\$69.26

M42 1.8L, M44 1.9L 318is 1989-00, 318ti 1992-00, Z3 1996-01

Head Gaskets

MLS Head Gaskets				
Bore	Thickness	Pkg Qty	Part #	List Price
85mm	.060"	1	C4348-060	\$185.43
86mm	.060"	1	C4349-060	\$185.43

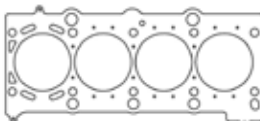

Additional thicknesses available see page 5

Individual Gaskets

Exhaust Manifold Gasket Set		
Application	Part #	List Price
M42B18/M44B18 .060" HTS	C14130-060	\$17.15



BMW

S14B20 1990cc 1986-91, S14B23 2302cc 1986-91 M3 86-91, 320is 1988-91

Head Gaskets

MLS Head Gaskets

Bore	Thickness	Pkg Qty	Part #	List Price
93.4mm	.051"	1	C4294-051	\$153.22
94.5mm	.051"	1	C4295-051	\$153.22

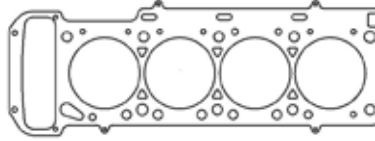

Additional thicknesses available
see page 5

M50B20 2.0L 1989-98 320i 1991-95, 520i 1991-95

Head Gasket

MLS Head Gasket

Bore	Thickness	Pkg Qty	Part #	List Price
82mm	.070"	1	C4332-070	\$247.22

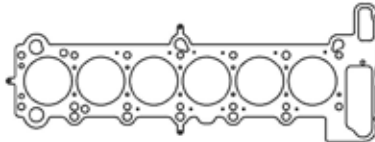

Additional thicknesses available
see page 5

M54tuB22 2.2L 1999-Up 320i, 320ci, 520i 00-03, Z3 2001-02, Z4 2003-Up

Head Gasket

MLS Head Gasket

Bore	Thickness	Pkg Qty	Part #	List Price
81mm	.030"	1	C4351-030	\$182.40

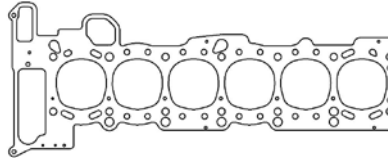

Additional thicknesses available
see page 5

M20B20 SOHC 12v 2.0L Inline 6 320 1977-82, 520 1977-81

Head Gasket

MLS Head Gasket

Bore	Thickness	Pkg Qty	Part #	List Price
81mm	.070"	1	C4393-070	\$247.22

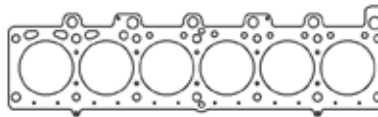

Additional thicknesses available
see page 5

M20B25/27 SOHC 12v 2.5/2.7L Inline 6 323i 1977-86, Z1 1988-93, 525e 1983-87, 528e 1981, 325e 1983-87

Head Gasket

MLS Head Gasket

Bore	Thickness	Pkg Qty	Part #	List Price
85mm	.070"	1	C4394-070	\$247.22

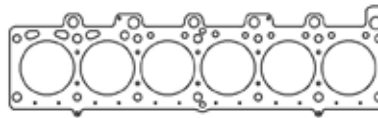

Additional thicknesses available
see page 5

See page 75 for additional gaskets



BMW

M20B25/27 SOHC 12v 2.5 / 2.7L Inline 6 323i 1977-86, Z1 1988-93, 525e 1983-87, 528e 1981, 325e 1983-87

Individual Gaskets

Valve Cover Gasket		
Application	Part #	List Price
BMW M20 2.5/2.7L .059" CFM.....	C4800-059	\$12.26

Oil Pan Gasket		
Application	Part #	List Price
BMW M20 2.5/2.7L.....	C4801-060	\$8.05

Intake Manifold Gasket Set		
Application	Part #	List Price
325e 1984-87 Small Port.....	C4884	\$10.64
325/325is 87-93 Normal Ports.....	C4885	\$13.82

Rear Main Seal		
Application	Part #	List Price
BMW M20 2.5/2.7L.....	C4802	\$22.72

Exhaust Manifold Gasket Set		
Application	Part #	List Price
BMW M20 2.5/2.7L .064" AM	C4798-064	\$14.86

Timing Cover Set		
Application	Part #	List Price
BMW M20 2.5/2.7L.....	C4803	\$11.87

Thermostat Gasket		
Application	Part #	List Price
BMW M20 2.5/2.7L.....	C4799	\$7.83

Water Pump Gasket		
Application	Part #	List Price
BMW M20 2.5/2.7L .020" Fiber	C4804-020	\$2.56

Gasket Kits



To purchase a complete gasket kit order both top end and bottom end gasket kit

TOP END GASKET KIT

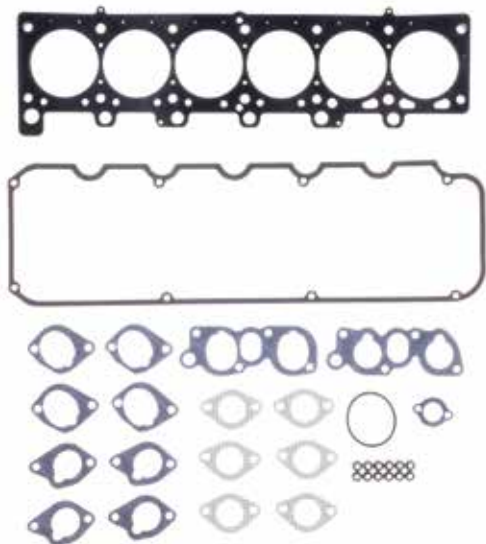

Application	Part #	List Price
BMW M20 2.5/2.7L 85mm Bore	PRO2028T	\$278.41

BOTTOM END GASKET KIT



Application	Part #	List Price
BMW M20 2.5/2.7L.....	PRO2028B	\$56.76

M30B25/B28 2.5/2.8L Inline 6, 628Csi 1979-81, 525 1973-78, 525i 1978-81, 525 1973-81

Head Gasket

MLS Head Gasket				
Bore	Thickness	Pkg Qty	Part #	List Price
88mm	.070"	1	C4475-070	\$203.37

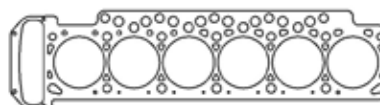

Additional thicknesses available see page 5



BMW

M50B25/28 2.5/2.8L Inline 6, 328i 1995-00, 528i 1995-99, 728i 1995-99, Z3 1997-99, 325i 1991-95, 525i 1992-95, 525ix 1992-95

Head Gasket

MLS Head Gasket

Bore	Thickness	Pkg Qty	Part #	List Price
85mm	.070"	1	C4328-070	\$247.22
85mm	.092"	1	C4328-092	\$264.54
85mm	.140"	1	C4328-140	\$279.68

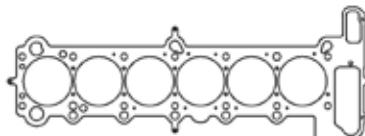

Additional thicknesses available see page 5

MLX Head Gasket

Bore	Thickness	Pkg Qty	Part #	List Price
85mm	.067"	1	C14010-067	\$243.25
85mm	.073"	1	C14010-073	\$243.25
85mm	.142"	1	C14010-142	\$279.68

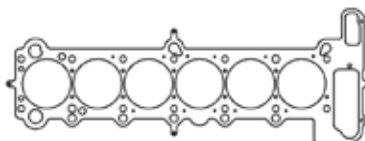

Individual Gaskets

Exhaust Header Gasket Set

Application	Part #	List Price
M50B25/28 .060" HTS	C14128-060	\$25.72

Timing Cover

Application	Part #	List Price
M50B25 .020" Fiber	C14129	\$9.95

M54tuB25/B28 2.5/2.8L & M52B25/M54B30 325i 2001-05, 325xi 2001-05, 325Ci 2001-06, 525i 2001-03, Z3 2001-06, X5 2001-06

Head Gasket

MLS Head Gasket

Bore	Thickness	Pkg Qty	Part #	List Price
85mm	.030"	1	C4352-030	\$182.40

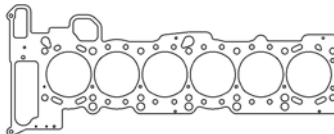

Additional thicknesses available see page 5

M30B30/B32 3.0/3.2L Inline 6 630CS 1979, 633 CSi 76-84

Head Gasket

MLS Head Gasket

Bore	Thickness	Pkg Qty	Part #	List Price
90mm	.070"	1	C4476-070	\$203.37

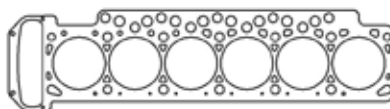

Additional thicknesses available see page 5

S50B30/S52B32 3.0/3.2L Inline 6 (E36) M3 96-99, M Roadster 96-00, M Coupe 96-00 (US Spec ONLY)

Head Gasket

MLS Head Gasket

Bore	Thickness	Pkg Qty	Part #	List Price
87mm	.066"	1	C4329-066	\$247.22
87mm	.070"	1	C4329-070	\$247.22
87mm	.075"	1	C4329-075	\$247.22

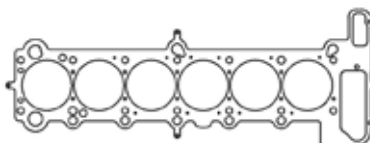

Additional thicknesses available see page 5

Individual Gaskets

Exhaust Header Gasket Set

Application	Part #	List Price
M52/S52	C14131-060	\$26.00



BMW

S50B30/S52B32 3.0/3.2L Inline 6 (E36) M3 1992-00 (Euro Models Only)

Head Gasket

MLS Head Gasket				
Bore	Thickness	Pkg Qty	Part #	List Price
87mm066"1	C4508-066\$247.22
87mm070"1	C4508-070\$247.22
87mm075"1	C4508-075\$247.22

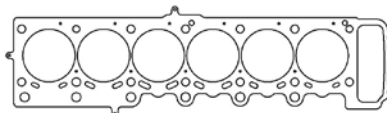

Additional thicknesses available see page 5

N54B30 3.0L Inline 6 (E60) 535i 2007-10, (E90 / E91 / E92 / E93) 335i 2007-10, (E82 / E88) 135i 2007-10, X6 2008-10, Z4 2009-16

Head Gasket

MLX Head Gasket				
Bore	Thickness	Pkg Qty	Part #	List Price
85mm044"1	C15257-044\$195.77
85mm048"1	C15257-048\$243.25
85mm052"1	C15257-052\$243.25

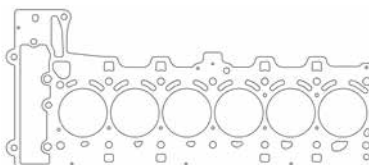

Additional thicknesses available see page 5

N55B30/N55B30M0/N55B30O0/N55B30T0/N55HP 3.0L Inline 6 335i 2011-16, 435i 2014-16, 535i 11-17, M2 2014-17, X6 2011-17

MLX Head Gasket

Bore	Thickness	Pkg Qty	Part #	List Price
85mm059"1	C15476-044\$195.77

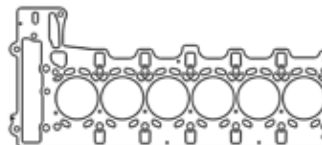

Additional thicknesses available see page 5

S54B32 3.2L Inline 6 M3 (E46) 2001-06, Z3 (E36) 2001-02, Z4 (E85) 2006-Up

Head Gasket

MLS Head Gasket				
Bore	Thickness	Pkg Qty	Part #	List Price
87.5mm070"1	C4505-070\$218.44

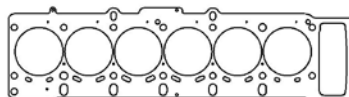

Additional thicknesses available see page 5

S55B30T0 3.0L Inline 6 M2 Competition 19-20, M3 15-18, M4 15-20

MLS Head Gasket

Bore	Thickness	Pkg Qty	Part #	List Price
85mm044"1	C14133-044\$195.77

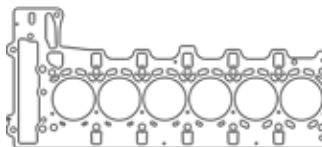

Additional thicknesses available see page 5

B58B30M0/B58B30M1 3.0L Inline 6 340i 16-18, 640i 16-18, M240i 17-20, X3 18-19

MLS Head Gasket

Bore	Thickness	Pkg Qty	Part #	List Price
83mm036"1	C14121-036\$182.40

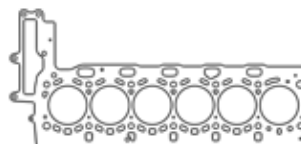

Additional thicknesses available see page 5



BMW

M30B34/M30B35 3.4L Inline 6, 5 Series 1985-88, 6 Series 1985-87, 7 Series 1985-87

Head Gasket

MLS Head Gasket

Bore	Thickness	Pkg Qty	Part #	List Price
93mm	.070"	1	C4477-070	\$203.37

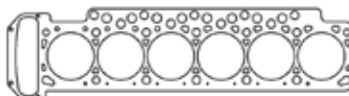

Additional thicknesses available see page 5

S38B35 3.5L Inline 6 M5 1984-92, M5i 1984-92, M6 1984-92

Head Gasket

MLS Head Gasket

Bore	Thickness	Pkg Qty	Part #	List Price
95mm	.070"	1	C4478-070	\$203.37

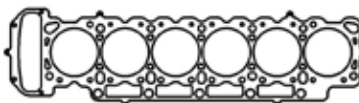

Additional thicknesses available see page 5

S65B40 4.0L V8 M3 (E90, E92, E93) 2007+Up

Head Gaskets

MLS Head Gaskets

Bore	Thickness	Pkg Qty	Part #	List Price
93mm	.027"	1	C5111-027	\$145.93
94mm	.027"	1	C5112-027	\$145.93

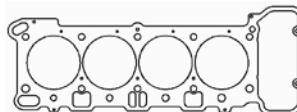

Additional thicknesses available see page 5

N63B44/S63B44 Alpina B6/B7 11-18, 550i 11-17, 650i 12-18, 750i 09-18, M5 13-16, M6 12-18, X5 10-18, X6 08-18

Head Gasket

MLS Head Gasket

Bore	Thickness	Pkg Qty	Part #	List Price
90mm	.040"	1	C15475-032	\$97.27
90mm	.040"	1	C15475-040	\$97.27

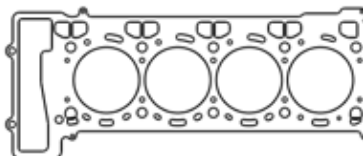

Additional thicknesses available see page 5

N62B44 4.4L V8 X5 04, 745i 04, 745Ci 04, 545i 04, 645Ci 04

Head Gasket

MLS Head Gasket

Bore	Thickness	Pkg Qty	Part #	List Price
94mm	.027"	1	C4374-027	\$153.22

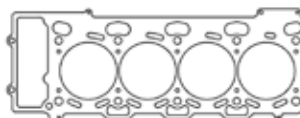

Additional thicknesses available see page 5

S85B50 5.0L V10 M5 2005-Up, M6 2005-Up

Head Gaskets

MLS Head Gaskets

Bore	Thickness	Pkg Qty	Part #	List Price
93mm	.027"	1	C4528-027	\$145.93
94.5mm	.027"	1	C4529-027	\$145.93
94.5mm	.045"	1	C4529-045	\$145.93
94.5mm	.051"	1	C4529-051	\$145.93

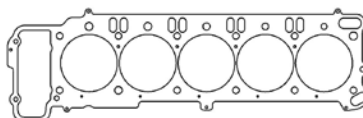

Additional thicknesses available see page 5



COVENTRY CLIMAX

FWA SOHC 1.1L 1098cc

Head Gasket

CFM-20 Head Gasket

Bore	Thickness	Pkg Qty	Part #	List Price
74mm	.043"	1	C4301-043	\$88.74
74mm	.059"	1	C4301-059	\$88.74

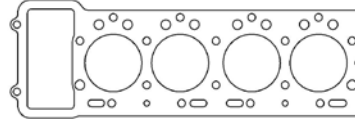

Additional thicknesses available
see page 5

FWB/FWE SOHC 1.2L & 1.5L

Head Gasket

CFM-20 Head Gasket

Bore	Thickness	Pkg Qty	Part #	List Price
78mm	.043"	1	C4139-043	\$88.74
78mm	.059"	1	C4139-059	\$88.74

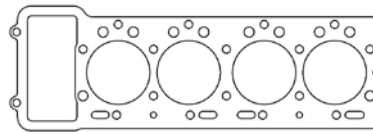

Additional thicknesses available
see page 5

FWA/FWB/FWE SOHC 2.0L

Head Gasket

CFM-20 Head Gasket

Bore	Thickness	Pkg Qty	Part #	List Price
80mm	.043"	1	C4229-043	\$88.74
80mm	.059"	1	C4229-059	\$88.74

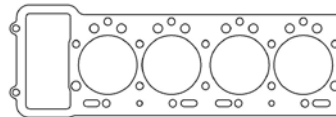

Additional thicknesses available
see page 5

FPF DOHC 1.5L

Head Gasket

CFM-20 Head Gasket

Bore	Thickness	Pkg Qty	Part #	List Price
82mm	.043"	1	C4267-043	\$97.33
82mm	.059"	1	C4267-059	\$97.33

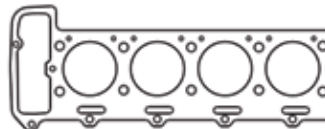

Additional thicknesses available
see page 5

FERRARI

308 V8 2v 1974-81

Head Gaskets

MLS Head Gaskets

Bore	Thickness	Pkg Qty	Part #	List Price
81mm	.045"	1	C4430-045	\$153.22
89mm	.045"	1	C4395-045	\$153.22

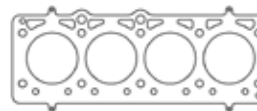

Additional thicknesses available
see page 5

308 V8 4v 1982-84

Head Gaskets

MLS Head Gaskets

Bore	Thickness	Pkg Qty	Part #	List Price
83mm	.045"	1	C4428-045	\$153.22
89mm	.045"	1	C4429-045	\$153.22

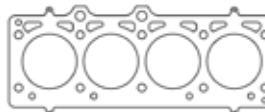

Additional thicknesses available
see page 5



FERRARI

F40 2.9L Twin Turbo V8 1987-92

Head Gasket

MLS Head Gasket				
Bore	Thickness	Pkg Qty	Part #	List Price
84mm067"1	C4482-067\$185.43

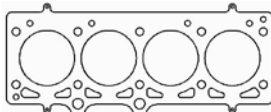

Additional thicknesses available see page 5

FIAT / LANCIA

138.A2 1.5L 1498cc 14 Bolt Head:1986-88 X1/9

Head Gasket

MLS Head Gasket				
Bore	Thickness	Pkg Qty	Part #	List Price
88mm044"1	C4952-044\$97.27

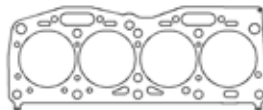

Additional thicknesses available see page 5

Lancia Delta

Head Gasket

MLS Head Gasket				
Bore	Thickness	Pkg Qty	Part #	List Price
85mm040"1	C4124-040\$97.27

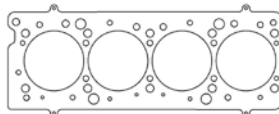

Additional thicknesses available see page 5

FORD / LOTUS

1.0L 2014-Up Fox EcoBoost

Head Gasket

NEW!

MLX Head Gasket				
Bore	Thickness	Pkg Qty	Part #	List Price
73mm032"1	C14140-032\$100.57

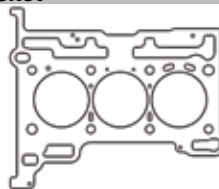

Additional thicknesses available see page 5

1.7L Zetec-S 1997-02 Puma

Head Gasket

Rubber Coated Stainles Head Gasket				
Bore	Thickness	Pkg Qty	Part #	List Price
83mm010"1	C4223-010\$60.78

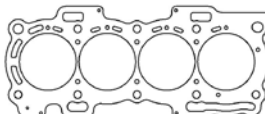

Additional thicknesses available see page 5



FORD / LOTUS

2.0L SOHC/DOHC NEP/YB Group A

Head Gasket

MLS Head Gasket				
Bore	Thickness	Pkg Qty	Part #	List Price
92.5mm	.040"	1	C4350-040	\$97.27

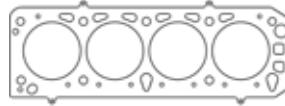

Additional thicknesses available
see page 5

Individual Gaskets

Intake Gasket Set		
Application	Part #	List Price
Cosworth YB	C4502	\$45.38

Oil Pan Gasket		
Application	Part #	List Price
Cosworth YB Rails only	C4640	\$17.10

Exhaust Manifold Gasket Set		
Application	Part #	List Price
Cosworth YB	C4334	\$18.22

Front Cover Gasket		
Application	Part #	List Price
Cosworth YB	C4641	\$10.18

Valve Cover Gaskets		
Application	Part #	List Price
Early YB Engine - .060" AFM	C4635	\$30.69
Late YB Engine - .060" AFM	C4636	\$30.69

Cooling/Water Pump Gasket		
Application	Part #	List Price
Water Pump Gasket	C4637	\$5.80
Water Outlet Gasket	C4638	\$2.58
Thermostat Gasket	C4639	\$2.42

2.0L 2012-15 EcoBoost DOHC

Head Gasket

MLS Head Gasket				
Bore	Thickness	Pkg Qty	Part #	List Price
89mm	.034"	1	C15317-034	\$102.16
89mm	.066"	1	C15317-066	\$141.78

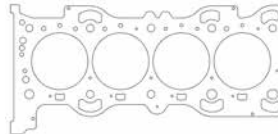

Additional thicknesses available
see page 5

2.3L EcoBoost DOHC: 2016-2018 Ford Focus RS

Head Gasket

MLX Head Gasket				
Bore	Thickness	Pkg Qty	Part #	List Price
89mm	.040"	1	C15294-040	\$120.47

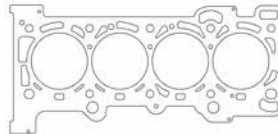

Additional thicknesses available
see page 5

Valve Cover Gasket		
Application	Part #	List Price
Valve Cover Gasket	C15445	\$36.40



FORD / LOTUS

Cosworth Ford 4cyl - FVA 1.6L/FVC 1.8L Gear Driven

Head Gaskets

MLS Head Gaskets

Bore	Thickness	Pkg Qty	Part #	List Price
87mm	.040"	1	C4138-040	\$97.27
88mm	.040"	1	C4135-040	\$97.27

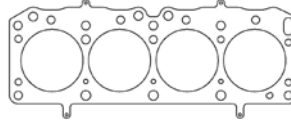

Additional thicknesses available
see page 5

Individual Gaskets

Valve Cover Gasket

Application	Part #	List Price
FVA/FVC .060" AFM	C4887	\$29.35

Oil Pan Gasket

Application	Part #	List Price
FVA/FVC .060" AFM (Rails only)	C4891	\$17.10

Exhaust Gasket Set

Application	Part #	List Price
FVA/FVC .064" AM (4 Pack)	C4888	\$17.31

Rear Cover Gasket

Application	Part #	List Price
FVA/FVC .060" AFM	C4892	\$3.84

Thermostat Housing Gasket

Application	Part #	List Price
FVA/FVC .060" AFM	C4889	\$1.35

Oil Pump Gasket

Application	Part #	List Price
FVA/FVC .060" AFM	C4893	\$2.58

Front Cylinder Head Cover Gasket

Application	Part #	List Price
FVA/FVC .060" AFM	C4890	\$5.05

Front Lower Cover Gasket

Application	Part #	List Price
FVA/FVC .012" Fiber	C4894	\$11.43

Cosworth Ford 4cyl 1.1-2.0L - BDA Series/Lotus Twin Cam, All Pushrod, Chain, & Belt Driven

Head Gaskets

MLS Head Gaskets

Bore	Thickness	Pkg Qty	Part #	List Price
82mm	.040"	1	C4102-040	\$97.27
83mm	.040"	1	C4103-040	\$97.27
84mm	.040"	1	C4140-040	\$97.27
85mm	.040"	1	C4133-040	\$97.27
86mm	.040"	1	C4142-040	\$97.27
87mm	.040"	1	C4143-040	\$97.27

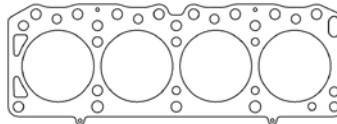

Additional thicknesses available
see page 5

MLS Head Gaskets - BDG

Bore	Thickness	Pkg Qty	Part #	List Price
91mm	.040"	1	C4494-040	\$97.27

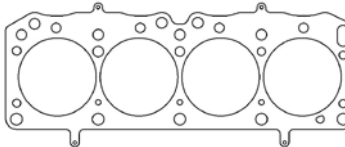

Individual Gaskets

Valve Cover Gaskets

Application	Part #	List Price
Lotus Twin Cam Chain Driven	C4895	\$25.52
BDA Belt Driven .060" AFM	C4896	\$20.02

Oil Pan Gasket

Application	Part #	List Price
BDA Series .060" AFM (Rails only)	C4891	\$17.10

Exhaust Gasket Sets

Application	Part #	List Price
Lotus Twin Cam 2 Bolt (4pk)	C4355-064	\$7.98
BDA 4 Bolt (4pk)	C4353-064	\$17.05
BDA 3 Bolt (4pk)	C4354-064	\$17.05

Rear Cover Gasket

Application	Part #	List Price
BDA Series/Lotus Twin Cam .060" AFM	C4892	\$3.84

Intake Gasket Set

Application	Part #	List Price
BDA Series/Lotus Twin Cam	C4897	\$15.29

Oil Pump Gasket

Application	Part #	List Price
BDA Series/Lotus Twin Cam .060" AFM	C4893	\$2.58

Thermostat Housing Gasket

Application	Part #	List Price
BDA Series/Lotus Twin Cam .060" AFM	C4889	\$1.35

Front Lower Cover Gasket

Application	Part #	List Price
BDA Series .012" Fiber	C4894	\$11.43



FORD / LOTUS

2.0L Zetec DOHC 4cyl 1995-04

Head Gasket

MLS Head Gasket

Bore	Thickness	Pkg Qty	Part #	List Price
87mm	.027"	1	C4279-027	\$93.07

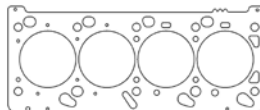

Additional thicknesses available see page 5

Individual Gaskets

Valve Cover Gaskets

Application	Part #	List Price
2.0L Zetec DOHC 1995-97	C4643	\$29.44
2.0L Zetec DOHC 1998-04	C4644	\$29.44

Valve Stem Seals

Application	Part #	List Price
2.0L Zetec 1995-97 (16pk)	3181V-16	\$46.34
2.0L Zetec 1998-04 (16pk)	3182V-16	\$49.91

Exhaust Gasket Sets

Application	Part #	List Price
2.0L Zetec 1994-04	C4645	\$19.18

Oil Pan Gasket

Application	Part #	List Price
2.0L Zetec 1995-04	C4649	\$27.45

Intake Gasket Set

Application	Part #	List Price
2.0L Zetec 1998-04	C4646	\$15.65
2.0L Zetec 1995-97	C4647	\$46.99

Thermostat Gaskets

Application	Part #	List Price
2.0L Zetec 1995-04 - Seal	C4651	\$1.92
2.0L Zetec 1995-04 - Housing	C4652	\$4.91

Cam Seal Set

Application	Part #	List Price
2.0L Zetec 1994-04	C4648	\$13.84

Rear Main Seal Set

Application	Part #	List Price
2.0L Zetec 1995-04	C4650	\$17.08

Gasket Kits



To purchase a complete gasket kit order both top end and bottom end gasket kit

TOP END GASKET KITS



Application	Part #	List Price
2.0L Zetec DOHC 1995-97 87mm Bore	PRO2029T	\$245.39
2.0L Zetec DOHC 1998-04 87mm Bore	PRO2030T	\$245.39

BOTTOM END GASKET KITS



Application	Part #	List Price
2.0L Zetec DOHC 1995-97	PRO2029B	\$113.58
2.0L Zetec DOHC 1998-04	PRO2030B	\$113.58



FORD / LOTUS

2.3L "2300" SOHC 1974-97 4cyl

Head Gaskets

MLS Head Gaskets

Bore	Thickness	Pkg Qty	Part #	List Price
3.830"040"1	C5369-040\$76.56
3.940"040"1	C5709-040\$76.56

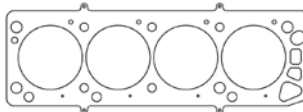

Additional thicknesses available
see page 5

Individual Gaskets

Valve Cover Gasket

Application	Part #	List Price
2300 2.3L 1974-93	C4653\$23.56

Exhaust Gasket Set

Application	Part #	List Price
2300 2.3L 1974-93	C5372-064\$16.58

Intake Gasket

Application	Part #	List Price
2300 2.3L	C5371-060\$14.06

Valve Stem Seals

Application	Part #	List Price
2300 2.3L 1974-93 (need 8)	3168V\$2.53

Oil Pan Gaskets

Application	Part #	List Price
2300 2.3L 1974-2/19/86	C5373\$17.68
2300 2.3L 2/20/86-1990	C4669\$27.68
2300 2.3L 1991-92	C4741\$21.74
2300 2.3L 1993	C4778\$21.74

Rear Main Seal Sets

Application	Part #	List Price
2300 2.3L 1974-81 2pc	C5688\$29.35
2300 2.3L 1982-93 1pc	C5189\$18.49

Water Pump Gasket

Application	Part #	List Price
2300 2.3L 1974-93	C4654\$2.56

Gasket Kits



To purchase a complete gasket kit order both top end and bottom end gasket kit

TOP END GASKET KIT



Application	Part #	List Price
2300 2.3L 1974-97 3.830" Bore	PRO2031T\$204.48

BOTTOM END GASKET KIT

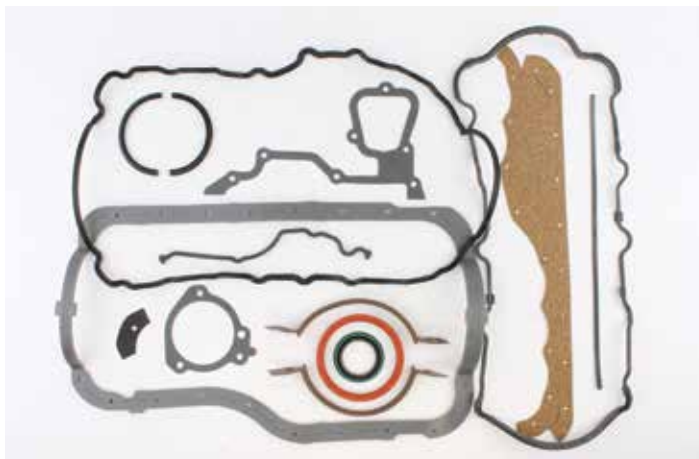

Application	Part #	List Price
2300 2.3L 1974-97	PRO2031B\$221.52



FORD / LOTUS

2.0L 2003-11 & 2.3L 2003-08 Duratec/Mazda MZR DOHC

Head Gaskets

MLS Head Gaskets

Bore	Thickness	Pkg Qty	Part #	List Price
89.5mm	.018"	1	C5843-018	\$102.16
92mm	.018"	1	C5842-018	\$102.16

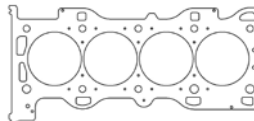

Additional thicknesses available
see page 5

Individual Gaskets

Intake Gasket

Application	Part #	List Price
2.3L Duratec 2003-08	C4842-060	\$19.05

Exhaust Manifold Gaskets

Application	Part #	List Price
2.3L Duratec (w/ extra port)	C4840-064	\$25.52
2.3L Duratec (w/o extra port)	C4841-064	\$25.52

3.0L Essex V6 1966-88

Head Gasket

MLS Head Gasket

Bore	Thickness	Pkg Qty	Part #	List Price
95mm	.040"	1	C4971-040	\$75.25



Additional thicknesses available
see page 5

4.0L Barra Inline 6 DOHC 2002-Present

Head Gaskets

MLS Head Gasket

Bore	Thickness	Pkg Qty	Part #	List Price
93mm	.030"	1	C5957-030	\$182.40

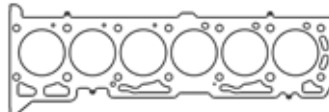

Additional thicknesses available
see page 5

4.0L Intech Inline 6 1998-02

Head Gaskets

MLS Head Gasket

Bore	Thickness	Pkg Qty	Part #	List Price
3.695"	.040"	1	C4597-040	\$182.40



Additional thicknesses available
see page 5



GM

ECOTEC 4 Cylinder

Head Gaskets

MLX Head Gasket - L3A/LE2/LFV/LV7/LYX 1.4L/1.5L 17-20

Bore	Thickness	Pkg Qty	Part #	List Price
75mm044"1	C15565-044	\$116.19

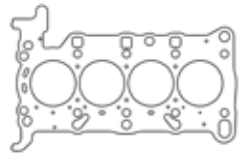

Additional thicknesses available
see page 5

MLS Head Gasket - LSJ 2.0L

Bore	Thickness	Pkg Qty	Part #	List Price
87mm027"1	C5921-027	\$102.16

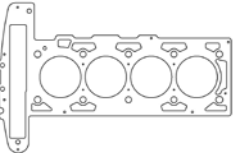

MLX Head Gasket - LSJ 2.0L

Bore	Thickness	Pkg Qty	Part #	List Price
87mm040"1	C5032-040	\$141.78

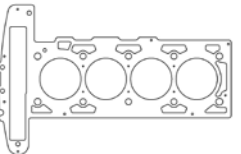

MLX Head Gasket - LNF 2.0L 08-10

Bore	Thickness	Pkg Qty	Part #	List Price
88mm032"1	C15256-032	\$141.78

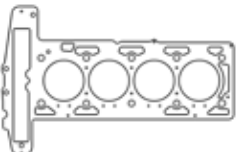

MLX Head Gasket - LTG 2.0L DOHC

Bore	Thickness	Pkg Qty	Part #	List Price
87mm028"1	C4964-028	\$141.78

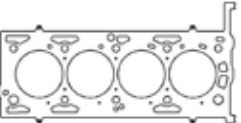

MLS Head Gaskets - L61/L42 2.2L DOHC

Bore	Thickness	Pkg Qty	Part #	List Price
87mm040"1	C5768-040	\$102.16
89mm040"1	C5804-040	\$102.16

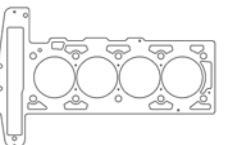

MLX Head Gaskets - LAT/LE5/LE9 Gen-2 ECOTEC 2.4L

Bore	Thickness	Pkg Qty	Part #	List Price
89.6mm036"1	C15422-036	\$141.78

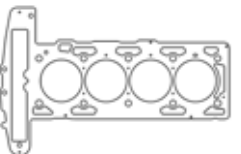

Individual Gaskets

MLS Exhaust Gasket - L42/L61/LAT/LE5 Gen-1/2 ECOTEC 2.2/2.4L

Application	Part #	List Price
2000-2009 2.2/2.4L	C4150-030	\$24.69

2.2L 134ci "L43/LN2": Cavalier/Sunfire FWD 1998-02, S-10/Sonoma RWD 1998-03

Head Gaskets

MLS Head Gaskets

Bore	Thickness	Pkg Qty	Part #	List Price
90mm030"1	C5914-030	\$102.16
93mm030"1	C5915-030	\$102.16

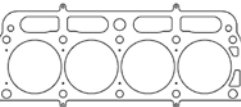

Additional thicknesses available
see page 5



GM

2.4L 146ci "LD9" Twin Cam 1996-2001

Head Gaskets

MLS Head Gasket - 1996-99 w/EGR				
Bore	Thickness	Pkg Qty	Part #	List Price
3.595"	.030"	1	C5298-030	\$102.16

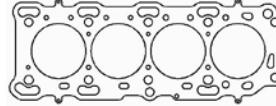

Additional thicknesses available
see page 5

MLS Head Gaskets - 1999-01 w/o EGR				
Bore	Thickness	Pkg Qty	Part #	List Price
3.595"	.030"	1	C5866-030	\$102.16
3.595"	.075"	1	C5866-075	\$141.78

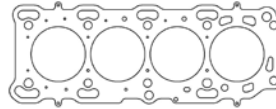

HOLDEN

Holden 253/304/308 V8

Head Gaskets

MLS Head Gasket				
Bore	Thickness	Pkg Qty	Part #	List Price
4.100"	.040"	1	C5806-040	\$104.70
4.200"	.040"	1	C5807-040	\$104.70
4.200"	.060"	1	C5807-060	\$142.38

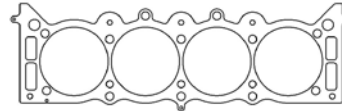

Additional thicknesses available
see page 5

Individual Gaskets

Valve Cover Gasket (sold individually)		
Application	Part #	List Price
253/304/308 V8	C15458-188	\$26.56

Fuel Pump Gasket		
Application	Part #	List Price
253/304/308 V8	C15456-031	\$4.15

Intake Gasket		
Application	Part #	List Price
253/304/308 V8	C15454-060	\$17.60

Exhaust Manifold Gaskets		
Application	Part #	List Price
253/304/308 V8	C15453-042	\$16.12

Timing Cover Set		
Application	Part #	List Price
253/304/308 V8	C15450-032	\$14.56

Water Pump Gasket		
Application	Part #	List Price
253/304/308 V8	C15451-032	\$14.56

Oil Pump Pickup Gasket		
Application	Part #	List Price
253/304/308 V8	C15452-032	\$2.08

Distbutor Gasket		
Application	Part #	List Price
253/304/308 V8	C15457-031	\$4.15

HONDA / ACURA

L15B7 1.5L DOHC VTC Turbo

Head Gaskets

MLS Head Gasket				
Bore	Thickness	Pkg Qty	Part #	List Price
73.5mm	.024"	1	C14019-024	\$97.27

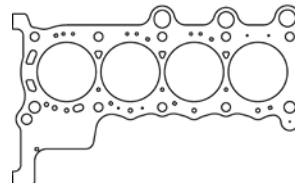

Additional thicknesses available
see page 5

Individual Gaskets

Valve Cover Gasket Set		
Application	Part #	List Price
L15B7	C14111	\$21.41



HONDA / ACURA

D15B1/B2/B7/B8 1988-95, D16A6/A7 1988-91 SOHC

Head Gaskets

MLX Head Gasket

Bore	Thickness	Pkg Qty	Part #	List Price
79mm	.032"	1	C14005-040	\$119.67
79mm	.040"	1	C14005-032	\$119.67

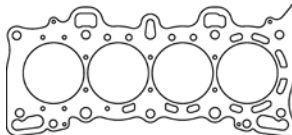

Additional thicknesses available
see page 5

MLS Head Gaskets

Bore	Thickness	Pkg Qty	Part #	List Price
75.5mm	.030"	1	C4117-030	\$97.27
76mm	.030"	1	C4118-030	\$97.27
77mm	.030"	1	C4119-030	\$97.27
78mm	.030"	1	C4120-030	\$97.27
79mm	.030"	1	C4121-030	\$97.27

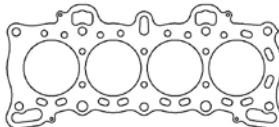

Individual Gaskets

Valve Cover Gasket Set

Application	Part #	List Price
D15B1/B2/B7, D16A6/A7	C4701	\$32.98

Oil Pan Gasket

Application	Part #	List Price
D15B1/B2/B7, D16A6/A7	C4660	\$36.04

Intake Gasket

Application	Part #	List Price
D15B1/B2/B7, D16A6/A7	C4702-060	\$13.73

Rear Main Seal Set

Application	Part #	List Price
D15B1/B2/B7, D16A6/A7	C4663	\$18.23

Exhaust Manifold Gasket

Application	Part #	List Price
D15B1/B2/B7, D16A6/A7 - MLS	C4164-030	\$24.69

Front Crank/Oil Pump Seal

Application	Part #	List Price
D15B1/B2/B7, D16A6/A7	C4664	\$4.44

Valve Stem Seals (sold individually)

Application	Part #	List Price
D15B1/B2/B7, D16A6/A7	3170V	\$1.35

Timing Cover Dust Seal Sets

Application	Part #	List Price
D15B1/B2/B7, D16A6/A7 - Lower	C4661	\$19.68
D15B1/B2/B7, D16A6/A8 - Upper	C4898	\$9.77

Cam Seal

Application	Part #	List Price
D15B1/B2/B7, D16A6/A7	C4703	\$4.61

Water Pump Mounting O-ring

Application	Part #	List Price
D15B1/B2/B7, D16A6/A7	C4700	\$3.91

Thermostat Seal Set

Application	Part #	List Price
D15B1/B2/B7, D16A6/A7	C4704	\$8.54

Gasket Kits



To purchase a complete gasket kit order both top end and bottom end gasket kit

TOP END GASKET KITS

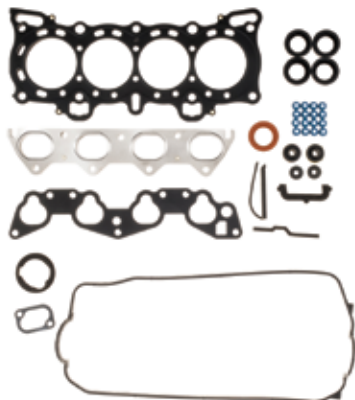

Application	Part #	List Price
D15B1/B2/B7 88-95 76mm Bore	PRO2032T	\$211.31
D16A6/A7 88-91 76mm Bore	PRO2034T	\$181.76

BOTTOM END GASKET KIT



Application	Part #	List Price
D15B1/B2/B7, D16A6/A7	PRO2032B	\$79.49



HONDA / ACURA

D16A1/A9 DOHC 1986-89

Head Gaskets

MLS Head Gaskets				
Bore	Thickness	Pkg Qty	Part #	List Price
75.5mm	.030"	1	C4522-030	\$97.27
76mm	.030"	1	C4524-030	\$97.27
77mm	.030"	1	C4525-030	\$97.27
78mm	.030"	1	C4526-030	\$97.27

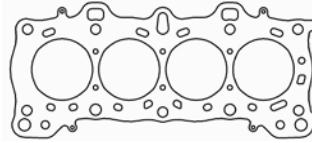

Additional thicknesses available
see page 5

Individual Gaskets

Valve Cover Gasket Set		
Application	Part #	List Price
D16A1/A9 1986-89	C4706	\$32.98

Oil Pan Gasket		
Application	Part #	List Price
D16A1/A9 1986-89	C4660	\$36.04

Intake Gasket		
Application	Part #	List Price
D16A1/A9 1986-89	C4707-046	\$8.00

Rear Main Seal Set		
Application	Part #	List Price
D16A1/A9 1986-89	C4663	\$18.23

Exhaust Manifold Gasket		
Application	Part #	List Price
D16A1/A9 1986-89	C4708	\$8.78

Front Crank/Oil Pump Seal		
Application	Part #	List Price
D16A1/A9 1986-89	C4664	\$4.44

Valve Stem Seals (sold individually)		
Application	Part #	List Price
D16A1/A9 1986-89	3177V	\$2.09

Water Pump Mounting O-ring		
Application	Part #	List Price
D16A1/A9 1986-89	C4700	\$3.91

Cam Seal		
Application	Part #	List Price
D16A1/A9 1986-89	C4709	\$9.11

Thermostat Seal		
Application	Part #	List Price
D16A1/A9 1986-89	C4710	\$5.40

Gasket Kits



To purchase a complete gasket kit order both top end and bottom end gasket kit

TOP END GASKET KIT



Application	Part #	List Price
D16A1/A9 1986-89	PRO2033T	\$181.76

BOTTOM END GASKET KIT



Application	Part #	List Price
D16A1/A9 1986-89	PRO2033B	\$68.13



HONDA / ACURA

D16Z6, D16Y5/Y7/Y8, D15Z1 1992-00 SOHC

Head Gaskets

MLS Head Gaskets

Bore	Thickness	Pkg Qty	Part #	List Price
75.5mm	.030"	1	C4251-030	\$97.27
76mm	.030"	1	C4195-030	\$97.27
77mm	.030"	1	C4196-030	\$97.27
78mm	.030"	1	C4167-030	\$97.27
79mm	.030"	1	C4197-030	\$97.27

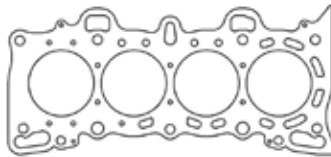

Additional thicknesses available
see page 5

MLX Head Gaskets

Bore	Thickness	Pkg Qty	Part #	List Price
79mm	.032"	1	C14134-032	\$119.67
79mm	.040"	1	C14134-040	\$119.67

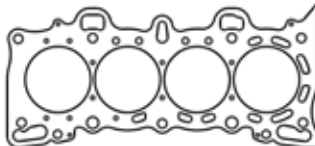

Individual Gaskets

Valve Cover Gasket Sets

Application	Part #	List Price
D16Z6 1992-95	C4655	\$29.44
D16Y5/Y7/Y8 1996-00	C4665	\$23.56

Throttle Body Gaskets

Application	Part #	List Price
D16Z6 1992-95	C4657-032	\$5.96
D16Y5/Y7/Y8 1996-00	C4667-032	\$5.96

Intake Gaskets

Application	Part #	List Price
D16Z6 1992-95	C4702-060	\$13.73
D16Y5/Y7/Y8 1996-00	C4666	\$12.18

Oil Pan Gaskets

Application	Part #	List Price
D16Z6 1992-95	C4660	\$36.04
D16Y5/Y8 1996-00	C4670	\$21.78
D16Y7 1996-00	C4899	\$21.78

Exhaust Manifold Gasket

Application	Part #	List Price
D16Z6, D16Y5/Y7/Y8 - MLS	C4164-030	\$24.69

Rear Main Seal Set

Application	Part #	List Price
D16Z6, D16Y5/Y7/Y8	C4663	\$18.23

Valve Stem Seals (sold individually)

Application	Part #	List Price
D16Z6, D16Y5/Y7/Y8	3170V	\$1.35

Front Crank/Oil Pump Seal

Application	Part #	List Price
D16Z6, D16Y5/Y7/Y8	C4664	\$4.44

Cam Seal

Application	Part #	List Price
D16Z6, D16Y5/Y7/Y8	C4658	\$10.35

Timing Cover Dust Seal Set

Application	Part #	List Price
D16Z6, D16Y5/Y7/Y8 - Lower	C4661	\$19.68

Thermostat Seal

Application	Part #	List Price
D16Z6, D16Y5/Y7/Y8	C4659	\$5.90

Water Pump Mounting O-ring

Application	Part #	List Price
D16Z6, D16Y5/Y7/Y8	C4662	\$4.91

See page 91 for StreetPro gasket kits



HONDA / ACURA

D16Z6, D16Y5/Y7/Y8, D15Z1 1992-00 SOHC

Gasket Kits



To purchase a complete gasket kit order both top end and bottom end gasket kit

TOP END GASKET KITS



Application	Part #	List Price
D16Z6 1992-95 76mm Bore.....	PRO2000T	\$176.47
D16Y5/Y7/Y8 1996-00 76mm Bore.....	PRO2001T	\$177.12

BOTTOM END GASKET KIT

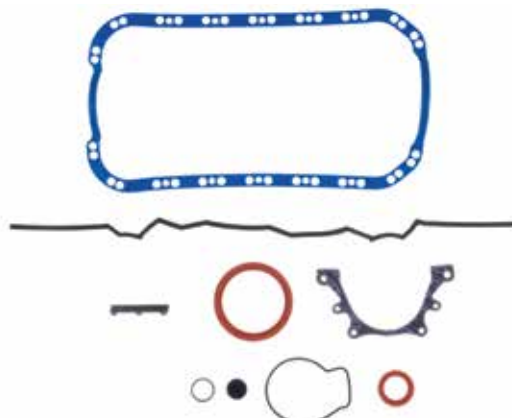

Application	Part #	List Price
D16Z6 1992-95.....	PRO2000B	\$61.27
D16Y5/Y7/Y8 1996-00.....	PRO2001B	\$64.50

D17A1/D17A2/D17A6 1.7L SOHC 2001-05

Head Gaskets

MLS Head Gaskets

Bore	Thickness	Pkg Qty	Part #	List Price
76mm027"	1	C4474-027	\$97.27
77mm027"	1	C4473-027	\$97.27
78mm027"	1	C4472-027	\$97.27
79mm027"	1	C4471-027	\$97.27



Additional thicknesses available see page 5

Individual Gaskets

Valve Stem Seals (sold individually)

Application	Part #	List Price
D17A1/A2/A6.....	3170V	\$1.35

Rear Main Seal

Application	Part #	List Price
D17A1/A2/A6.....	C4678	\$14.62

Cam Seal

Application	Part #	List Price
D17A1/A2/A6.....	C4658	\$10.35

Water Pump Mounting O-ring

Application	Part #	List Price
D17A1/A2/A6.....	C4662	\$4.91

B16A2/B16A3/B17A1/B18C1/B18C5 1.6/1.7/1.8L DOHC VTEC

Head Gaskets

MLX Head Gasket

Bore	Thickness	Pkg Qty	Part #	List Price
85mm043"	1	C4999-043	\$119.67

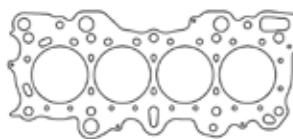

Additional thicknesses available see page 5

See page 92 for additional gaskets



HONDA / ACURA

B16A2/B16A3/B17A1/B18C1/B18C5 1.6/1.7/1.8L DOHC VTEC

Head Gaskets

MLS Head Gaskets

Bore	Thickness	Pkg Qty	Part #	List Price
81mm	.030"	1	C4231-030	\$97.27
81.5mm	.030"	1	C4232-030	\$97.27
82mm	.030"	1	C4168-030	\$97.27
83mm	.030"	1	C4189-030	\$97.27
84mm	.030"	1	C4188-030	\$97.27
85mm	.030"	1	C4182-030	\$97.27
86mm	.030"	1	C14061-030	\$97.27

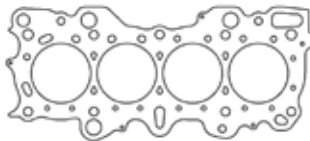

Additional thicknesses available
see page 5

Individual Gaskets

Valve Cover Gasket Set

Application	Part #	List Price
B16A2/A3 & B18C1/C5	C4628	\$23.56

Thermostat Seal

Application	Part #	List Price
B16A2/A3 & B18C1/C5	C4659	\$5.90

Intake Gaskets

Application	Part #	List Price
B16A2/A3 & B18C5	C4671-060	\$10.39
B18C1	C4674	\$12.47

Throttle Body Gaskets

Application	Part #	List Price
B16A3/B18C1 94-95	C4672-032	\$5.96
B16A2, B18C1/C5 96-01	C4656-032	\$5.96

Exhaust Manifold Gasket

Application	Part #	List Price
B16A2/A3 & B18C1/C5 - MLS	C4151-030	\$20.19

Oil Pan Gasket

Application	Part #	List Price
B16A2/A3 & B18C1/C5	C4676	\$20.36

Valve Stem Seals (sold individually)

Application	Part #	List Price
B16A2/A3 & B18C1/C5	3170V	\$1.35

Rear Main Seal

Application	Part #	List Price
B16A2/A3 & B18C1/C5	C4678	\$14.62

Cam Seal Set

Application	Part #	List Price
B16A2/A3 & B18C1/C5	C4675	\$17.73

Water Pump Mounting O-ring

Application	Part #	List Price
B16A2/A3 & B18C1/C5	C4677	\$2.56

Gasket Kits



To purchase a complete gasket kit order both top end and bottom end gasket kit

TOP END GASKET KIT

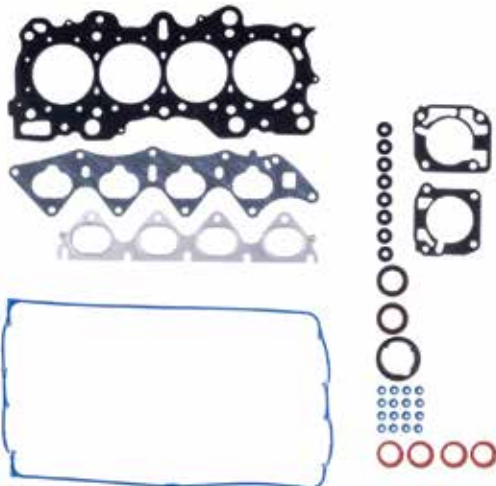

Application	Part #	List Price
B16A2/A3, B18C5 82mm Bore	PRO2002T	\$204.48
B18C1 GS-R 82mm Bore	PRO2003T	\$227.21

BOTTOM END GASKET KIT



Application	Part #	List Price
B16A2/A3, B18C1/C5	PRO2003B	\$64.60



HONDA / ACURA

B18A1/B18B1 1.8L DOHC non-VTEC 1990-01

Head Gaskets

MLS Head Gaskets				
Bore	Thickness	Pkg Qty	Part #	List Price
81mm	.030"	1	C4238-030	\$97.27
81.5mm	.030"	1	C4239-030	\$97.27
82mm	.030"	1	C4173-030	\$97.27
83mm	.030"	1	C4181-030	\$97.27
84mm	.030"	1	C4180-030	\$97.27
85mm	.030"	1	C4175-030	\$97.27

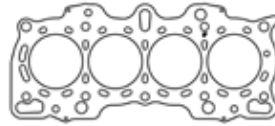

Additional thicknesses available see page 5

Individual Gaskets

Valve Cover Gasket Set		
Application	Part #	List Price
B18A1/B1	C4679	\$23.56

Throttle Body Gasket		
Application	Part #	List Price
B18A1 1990-93	C4681	\$5.96
B18B1 1994-95 Manual, 1994-01 Auto Trans Only	C4672-032	\$5.96
B18B1 1996-01 Manual Trans Only	C4656-032	\$5.96

Intake Gasket		
Application	Part #	List Price
B18A1/B1 .094" KF	C4680-094	\$22.02

Thermostat Seal		
Application	Part #	List Price
B18A1/B1	C4659	\$5.90

Exhaust Manifold Gasket		
Application	Part #	List Price
B18A1/B1 - .030" MLS	C4151-030	\$20.19

Oil Pan Gasket Set		
Application	Part #	List Price
B18A1/B1	C4676	\$20.36

Valve Stem Seals (sold individually)		
Application	Part #	List Price
B18A1/B1	3177V	\$2.09

Rear Main Seal Set		
Application	Part #	List Price
B18A1/B1	C4678	\$14.62

Cam Seal Set		
Application	Part #	List Price
B18A1/B1	C4709	\$9.11

Water Pump Mounting O-ring		
Application	Part #	List Price
B18A1/B1	C4677	\$2.56

Gasket Kits



To purchase a complete gasket kit order both top end and bottom end gasket kit

TOP END GASKET KIT

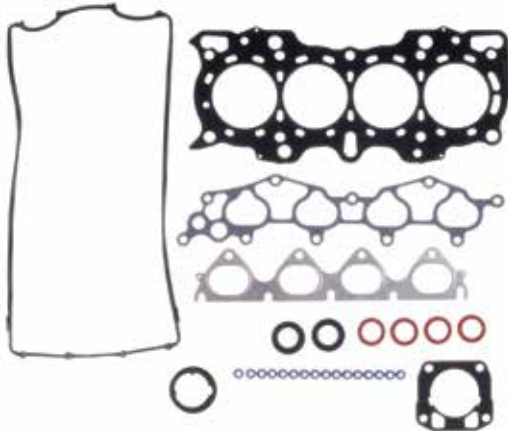

Application	Part #	List Price
B18A1/B1 1990-01 82mm Bore	PRO2004T	\$199.94

BOTTOM END GASKET KIT

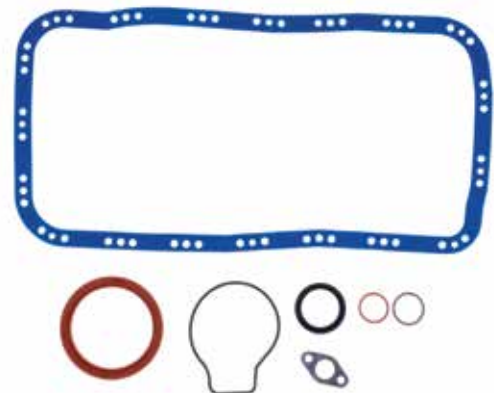

Application	Part #	List Price
B18A1/B1 1990-01	PRO2004B	\$61.27



HONDA / ACURA

B Series Hybrid (VTEC Head/non-VTEC Block)

Head Gaskets

MLS Head Gaskets

Bore	Thickness	Pkg Qty	Part #	List Price
81mm	.030"	1	C4237-030	\$97.27
81.5mm	.030"	1	C4236-030	\$97.27
82mm	.030"	1	C4191-030	\$97.27
83mm	.030"	1	C4192-030	\$97.27
84mm	.030"	1	C4193-030	\$97.27
84.5mm	.030"	1	C4241-030	\$97.27
85mm	.030"	1	C4194-030	\$97.27

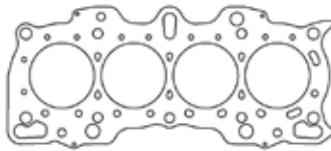

Additional thicknesses available
see page 5

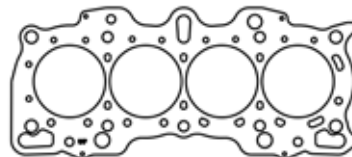

MLX Head Gasket

Bore	Thickness	Pkg Qty	Part #	List Price
85mm	.043"	1	C14000-043	\$119.67

Individual Gaskets

Valve Cover Gasket Set

Application	Part #	List Price
B16A2/A3 & B18C1/C5	C4628	\$23.56

Thermostat Seal

Application	Part #	List Price
B Series	C4659	\$5.90

Intake Gaskets

Application	Part #	List Price
B16A2/A3 & B18C5	C4671-060	\$10.39
B18C1	C4674	\$12.47

Throttle Body Gaskets

Application	Part #	List Price
B16A3/B18C1 94-95	C4672-032	\$5.96

Exhaust Manifold Gasket

Application	Part #	List Price
B16A2/A3 & B18C1/C5 - MLS	C4151-030	\$20.19

Oil Pan Gasket Set

Application	Part #	List Price
B Series	C4676	\$20.36

Valve Stem Seals (sold individually)

Application	Part #	List Price
B16A2/A3 & B18C1/C5	3170V	\$1.35

Rear Main Seal Set

Application	Part #	List Price
B Series	C4678	\$14.62

Cam Seal Set

Application	Part #	List Price
B16A2/A3 & B18C1/C5	C4675	\$17.73

Water Pump Mounting O-ring

Application	Part #	List Price
B Series	C4677	\$2.56

Gasket Kits



To purchase a complete gasket kit order both top end and bottom end gasket kit

TOP END GASKET KITS

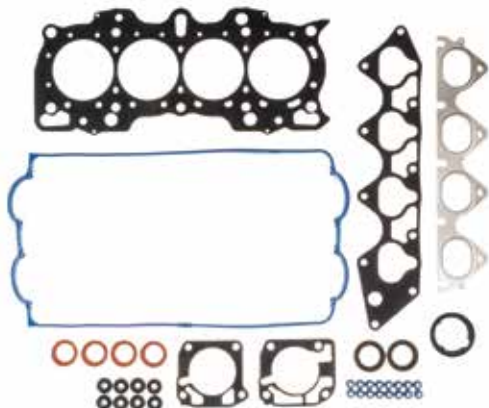

Application	Part #	List Price
B20 w/B18C1 Head (GS-R) 84.5mm Bore	PRO2049T	\$227.21
B20 w/B16A2/A3/B18C5 Head 84.5mm Bore	PRO2050T	\$204.48

BOTTOM END GASKET KIT



Application	Part #	List Price
B Series	PRO2004B	\$61.27



HONDA / ACURA

B20B4, B20Z2 2.0L DOHC non-VTEC 1997-01

Head Gasket

MLS Head Gasket				
Bore	Thickness	Pkg Qty	Part #	List Price
85mm	.030"	1	C4250-030	\$97.27

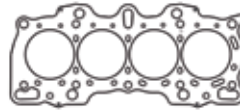

Additional thicknesses available see page 5

Individual Gaskets

Valve Cover Gasket Set		
Application	Part #	List Price
B20B4, B20Z2	C4679	\$23.56

Thermostat Seal		
Application	Part #	List Price
B20B4, B20Z2	C4659	\$5.90

Intake Gasket		
Application	Part #	List Price
B20B4, B20Z2 .094" KF	C4680-094	\$22.02

Oil Pan Gasket Set		
Application	Part #	List Price
B18A1/B1	C4676	\$20.36

Exhaust Manifold Gasket		
Application	Part #	List Price
B20B4, B20Z2 - .030" MLS	C4151-030	\$20.19

Rear Main Seal		
Application	Part #	List Price
B20B4, B20Z2	C4678	\$14.62

Valve Stem Seals (sold individually)		
Application	Part #	List Price
B20B4, B20Z2	3177V	\$2.09

Water Pump Mounting O-ring		
Application	Part #	List Price
B20B4, B20Z2	C4677	\$2.56

Cam Seal Set		
Application	Part #	List Price
B20B4, B20Z2	C4709	\$9.11

Throttle Body Gaskets		
Application	Part #	List Price
B20B4 With Auto Trans Only	C4657-032	\$5.96
B20B4 With Manual Trans Only	C4667-032	\$5.96
B20Z2 With Auto Trans Only	C4672-032	\$5.96
B20Z2 With Manual Trans Only	C4656-032	\$5.96

Gasket Kits



To purchase a complete gasket kit order both top end and bottom end gasket kit

TOP END GASKET KIT

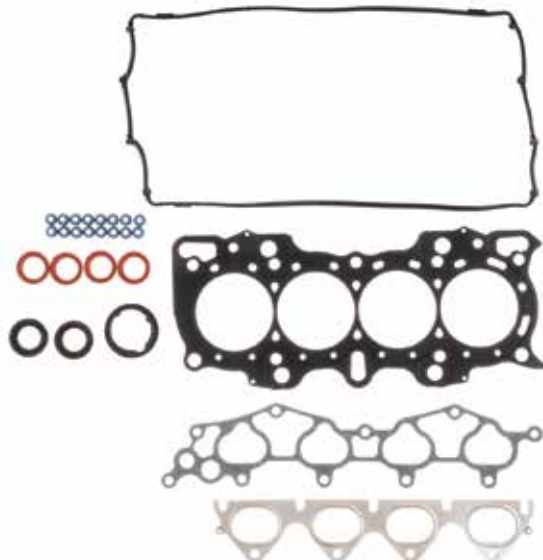

Application	Part #	List Price
B20B4, B20Z2 85mm Bore	PRO2035T	\$193.12

BOTTOM END GASKET KIT



Application	Part #	List Price
B Series	PRO2004B	\$61.27



HONDA / ACURA

B20A3/B20A5 2.0L 1988-91

Head Gaskets

MLS Head Gaskets

Bore	Thickness	Pkg Qty	Part #	List Price
81.5mm	.045"	1	C4564-045	\$97.27
82mm	.045"	1	C4565-045	\$97.27
83mm	.045"	1	C4566-045	\$97.27
84mm	.045"	1	C4567-045	\$97.27

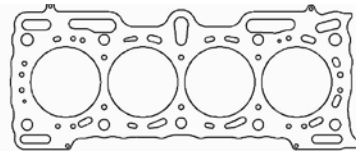

Additional thicknesses available
see page 5

F20B 2.0L DOHC 1997-01

Head Gasket

MLS Head Gasket

Bore	Thickness	Pkg Qty	Part #	List Price
86mm	.027"	1	C4634-027	\$97.27
86mm	.036"	1	C4634-036	\$97.27

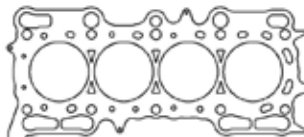

Additional thicknesses available
see page 5

B21A1 2.1L 1990-91

Head Gaskets

MLS Head Gaskets

Bore	Thickness	Pkg Qty	Part #	List Price
84mm	.040"	1	C4586-040	\$97.27
83mm	.045"	1	C4585-045	\$97.27
84mm	.045"	1	C4586-045	\$97.27

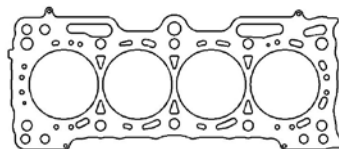

Additional thicknesses available
see page 5

K20A2/K20A3/K20Z1/K24A1

Head Gaskets

MLS Head Gaskets

Bore	Thickness	Pkg Qty	Part #	List Price
86mm	.030"	1	C4300-030	\$97.27
86.5mm	.030"	1	C14079-030	\$97.27
87mm	.030"	1	C4311-030	\$97.27
87mm	.040"	1	C4311-040	\$97.27
87.5mm	.030"	1	C14039-030	\$97.27
88mm	.030"	1	C4312-030	\$97.27
89mm	.030"	1	C4313-030	\$97.27
90mm	.040"	1	C14043-040	\$97.27

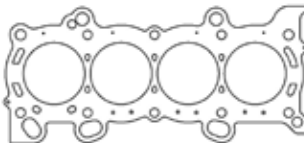

Additional thicknesses available
see page 5

MLX Head Gaskets

Bore	Thickness	Pkg Qty	Part #	List Price
89mm	.032"	1	C4596-032	\$136.41
89mm	.036"	1	C4596-036	\$136.41
89mm	.044"	1	C4596-044	\$136.41

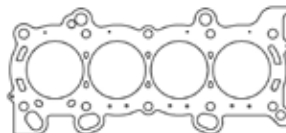

Additional thicknesses available
see page 5

Individual Gaskets

Exhaust Manifold Gaskets

Application	Part #	List Price
K20A1/A3 2002-04 - MLS	C4160-030	\$24.69
K20A2 - MLS	C4162-030	\$24.69

Rear Main Seal

Application	Part #	List Price
K-Series 2002+	C4705	\$33.60

Intake Gasket

Application	Part #	List Price
K20A2/A3 2001+	C4668	\$17.15

Oil Pan Gasket

Application	Part #	List Price
K20A1/A2/A3 2002-2013	C14011-060	\$26.00



HONDA / ACURA

K20C1/K20C4 2015-Present Civic Type R; 2018-Present Honda Accord/Acura RDX

Head Gaskets

MLS Head Gaskets

Bore	Thickness	Pkg Qty	Part #	List Price
87mm	.028"	1	C14014-028	\$97.27
88mm	.028"	1	C14021-028	\$97.27

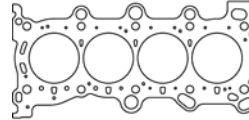

Additional thicknesses available
see page 5

Individual Gaskets

Turbo/Exhaust Gasket Kit

Application	Part #	List Price
K20C1 MLS	C14022-020	\$14.34

K20Z3 2.0L 2006-11

Head Gaskets

MLS Head Gaskets

Bore	Thickness	Pkg Qty	Part #	List Price
86mm	.030"	1	C4561-030	\$97.27
87mm	.030"	1	C4562-030	\$97.27

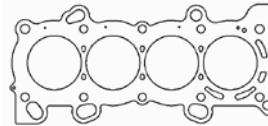

Additional thicknesses available
see page 5

Individual Gaskets

Valve Cover Gasket

Application	Part #	List Price
K-Series 2002+	C14012	\$14.55

Exhaust Manifold Gasket

Application	Part #	List Price
K20 Exhaust - AM Material	C14007-064	\$16.63

Rear Main Seal

Application	Part #	List Price
K-Series 2002+	C4705	\$33.60

Intake Gasket

Application	Part #	List Price
K20Z3	C14095	\$10.39

Oil Pan Gasket

Application	Part #	List Price
K20A1/A2/A3 2002-2013	C14011-060	\$26.00

Throttle Body Gaskets

Application	Part #	List Price
2.0L K20Z3 Fiber	C14008-031	\$5.60

NEW!

EGR Passage Gasket

Application	Part #	List Price
2.0L K20Z3	C14132-010	\$11.50

K24Z2/K24Z7 2.4L 2012-15

Head Gaskets

MLS Head Gaskets

Bore	Thickness	Pkg Qty	Part #	List Price
87mm	.030"	1	C4594-030	\$97.27
89mm	.030"	1	C4595-030	\$97.27
89mm	.036"	1	C4595-036	\$97.27

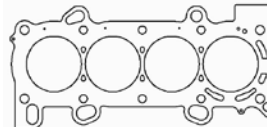

Additional thicknesses available
see page 5

Individual Gaskets

Rear Main Seal

Application	Part #	List Price
K-Series 2002+	C4705	\$33.60

Exhaust Manifold Gasket

Application	Part #	List Price
K24Z2 / K24Z3 / K24Z6 / K24Z7	C14013-039	\$14.42



WARNING: Cancer and Reproductive Harm www.P65Warnings.ca.gov



HONDA / ACURA

H22A1/H22A2 2.2L DOHC VTEC 1992-96

Head Gaskets

MLS Head Gaskets

Bore	Thickness	Pkg Qty	Part #	List Price
87mm	0.030"	1	C4255-030	\$97.27
88mm	0.030"	1	C4198-030	\$97.27
89mm	0.030"	1	C4185-030	\$97.27

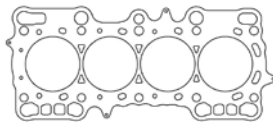

Additional thicknesses available
see page 5

MLX Head Gaskets

Bore	Thickness	Pkg Qty	Part #	List Price
89mm	0.032"	1	C14015-032	\$109.20

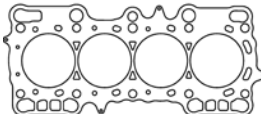

Individual Gaskets

Exhaust Manifold Gasket

Application	Part #	List Price
H22A1/H22A2 - MLS	C4155-030	\$30.32

Water Pump Gasket

Application	Part #	List Price
H22A1/H22A2	C4948	\$5.90

Valve Stem Seals (sold individually)

Application	Part #	List Price
H22A1/H22A2	3170V	\$1.35

Oil Pan Gasket Set

Application	Part #	List Price
H22A1/H22A2	C4158	\$21.74

Thermostat Seal

Application	Part #	List Price
H22A1/H22A2	C4659	\$5.90

Rear Main Seal

Application	Part #	List Price
H22A1/H22A2	C4678	\$14.62

Cam Seal Set

Application	Part #	List Price
H22A1	C4675	\$17.73

H22A4 1997-01, H22A7 1998-03 2.2L DOHC

Head Gaskets

MLS Head Gaskets

Bore	Thickness	Pkg Qty	Part #	List Price
87mm	0.018"	1	C4252-018	\$97.27
87mm	0.030"	1	C4252-030	\$97.27
88mm	0.030"	1	C4253-030	\$97.27
89mm	0.030"	1	C4254-030	\$97.27

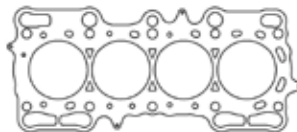

Additional thicknesses available
see page 5

Individual Gaskets

Exhaust Manifold Gasket

Application	Part #	List Price
H22A4/H22A7 - MLS	C4155-030	\$30.32

Water Pump Gasket

Application	Part #	List Price
H22A4/H22A7	C4948	\$5.90

Valve Stem Seals (sold individually)

Application	Part #	List Price
H22A4/H22A7	3170V	\$1.35

Oil Pan Gasket Set

Application	Part #	List Price
H22A4/H22A7	C4158	\$21.74

Thermostat Seal

Application	Part #	List Price
H22A4/H22A7	C4659	\$5.90

Rear Main Seal

Application	Part #	List Price
H22A4/H22A7	C4678	\$14.62

Cam Seal Set

Application	Part #	List Price
H22A1	C4675	\$17.73



HONDA / ACURA

H23A1 2.3L DOHC VTEC 1992-96

Head Gaskets

MLS Head Gaskets				
Bore	Thickness	Pkg Qty	Part #	List Price
87.5mm	.030"	1	C4553-030	\$97.27
88mm	.030"	1	C4554-030	\$97.27
89mm	.030"	1	C4555-030	\$97.27

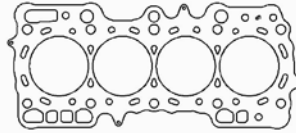

Additional thicknesses available
see page 5

Individual Gaskets

Cam Seal Set		
Application	Part #	List Price
H22A1	C4675	\$17.73

F22A1/A4 / A6 (1990-93 Accord, 1992-96 Prelude SOHC 16V)

Head Gaskets

MLS Head Gaskets				
Bore	Thickness	Pkg Qty	Part #	List Price
85mm	.045"	1	C14017-045	\$97.27

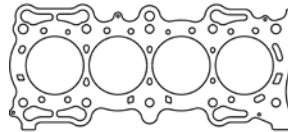

Additional thicknesses available
see page 5

F22B1/B4/B5/B8 2.2L SOHC 1994-97, *F23A1 1998-02

Head Gaskets

MLS Head Gaskets				
Bore	Thickness	Pkg Qty	Part #	List Price
86mm	.027"	1	C4618-027	\$97.27
87mm	.027"	1	C4619-027*	\$97.27
88mm	.027"	1	C4620-027*	\$97.27
89mm	.027"	1	C4621-027*	\$97.27

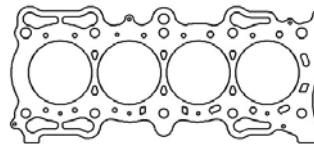

Additional thicknesses available
see page 5

Individual Gaskets

Exhaust Manifold Gasket		
Application	Part #	List Price
F22B1/F23A1 1994-01 .064" AM	C4190-064	\$12.36

F20C1/C2, F22C1 2.0/2.2L DOHC VTEC 1999-09

Head Gaskets

MLS Head Gaskets				
Bore	Thickness	Pkg Qty	Part #	List Price
87.5mm	.030"	1	C4625-030	\$97.27
88mm	.030"	1	C4626-030	\$97.27
88.5mm	.030"	1	C4627-030	\$97.27
89mm	.030"	1	C4335-030	\$97.27

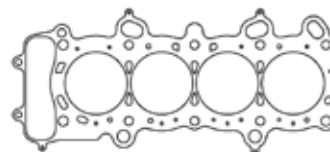

Additional thicknesses available
see page 5

Individual Gaskets

Exhaust Manifold Gasket		
Application	Part #	List Price
F20C1/C2 99-09 - MLS	C4159-030	\$24.69



HONDA / ACURA

C30A1, C32B1 DOHC 3.0/3.2L V6 1991-05

Head Gaskets

MLS Head Gaskets

Bore	Thickness	Pkg Qty	Part #	List Price
91mm030"1	C4550-030	\$109.42
93mm030"1	C4551-030	\$109.42
95mm030"1	C4277-030	\$109.42

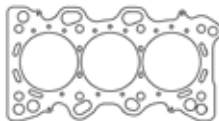

Additional thicknesses available
see page 5

J32A1/J32A2/J35A1/J35A3/J35A 3.5L SOHC V6 01-04 Stock and Darton Sleeves

Head Gaskets

MLS Head Gasket

Bore	Thickness	Pkg Qty	Part #	List Price
90mm027"1	C4382-027	\$88.74

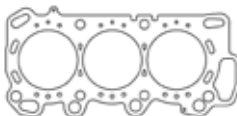

Additional thicknesses available
see page 5

JNC1 3.5L DOHC V6 2017-Plus

Head Gaskets

NEW!

MLS Head Gasket - Right Side

Bore	Thickness	Pkg Qty	Part #	List Price
90mm027"1	C14137-027	\$101.90



Additional thicknesses available
see page 5

NEW!

MLS Head Gasket - Left Side

Bore	Thickness	Pkg Qty	Part #	List Price
90mm027"1	C14138-027	\$101.90

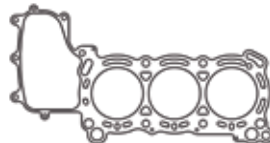

HYUNDAI

2.0L Theta II Turbo 4 Cylinder, Genesis G70 2019, Genesis Coupe 2010-14, Sonata Limited 2011, Kia Stinger 2018-Up, Kia Forte 2009-2013

Head Gaskets

MLX Head Gasket

Bore	Thickness	Pkg Qty	Part #	List Price
88mm032"1	C4953-032	\$120.47

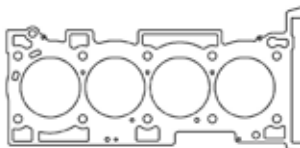

Additional thicknesses available
see page 5

3.8L G6DA DOHC V6 Azera 2007-11, Entourage 2007-10, Genesis 2009-12, Veracruz 2007-11, Kia Sedona 2006-10, Kia Sorento 2007-09

Head Gaskets

MLX Head Gasket - Left Side

Bore	Thickness	Pkg Qty	Part #	List Price
98mm032"1	C4632-032	\$100.57

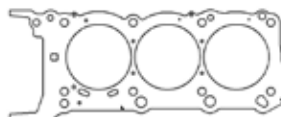

Additional thicknesses available
see page 5

MLX Head Gasket - Right Side

Bore	Thickness	Pkg Qty	Part #	List Price
98mm032"1	C4633-032	\$100.57

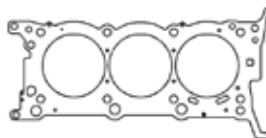



JAGUAR

3.4L DOHC Inline 6 XK120 1948-53, XK140 1954-57, XK150 1957-61, Mark VII 1950-57, Mark VIII 1956-58, Mark I 1957-59, Mark II 1959-67, 340 Mark II 1967-68, S-Type 1963-68

Head Gaskets

MLS Head Gaskets

Bore	Thickness	Pkg Qty	Part #	List Price
83mm	.040"	1	C4281-040	\$170.31
85mm	.040"	1	C4303-040	\$170.31

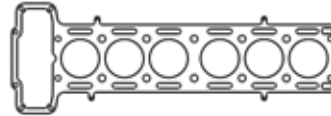

Additional thicknesses available see page 5

CFM-20 Head Gasket

Bore	Thickness	Pkg Qty	Part #	List Price
83mm	.059"	1	C4302-059	\$133.83
85mm	.059"	1	C4304-059	\$133.83

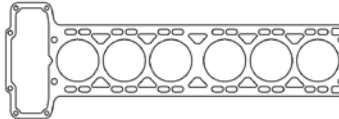

Individual Gaskets

Cam Cover Gasket Set

Application	Part #	List Price
3.4/3.8/4.2L (Trim to Fit)	C4545-060	\$43.75

Oil Pan Gasket

Application	Part #	List Price
3.4/3.8/4.2L .060" AFM	C4259-060	\$24.28

Intake Manifold Gaskets

Application	Part #	List Price
3.8/4.2L Str Port Head	C4230-060	\$18.38
3.4/3.8L B Type Head	C4244-060	\$18.38

Engine Cover Gaskets

Application	Part #	List Price
Front Main Seal Gasket	C4673-188	\$3.32
Rear Main Seal Gasket	C4901-188	\$3.32

Exhaust Manifold Gasket

Application	Part #	List Price
3.4/3.8/4.2L	C4217-059	\$11.19

Timing Cover Gasket

Application	Part #	List Price
3.4/3.8/E4.2L .018" AFM	C4336-018	\$19.79

Thermostat Gaskets

Application	Part #	List Price
Series 1 1965-67	C4375-060	\$2.42
Series 2 1968-71	C4379-060	\$2.42

Engine Oil Gaskets

Application	Part #	List Price
Oil Feed Gasket	C4949-032	\$2.42
Oil Filter Housing Gasket	C4179-032	\$3.65

Breather Cover Gasket Set

Application	Part #	List Price
3.4/3.8/4.2L	C4544-060	\$7.30

Water Pump Gasket

Application	Part #	List Price
3.4/3.8/E4.2L .018" AFM	C4337-018	\$6.23

3.8L DOHC Inline 6 XK150 3.8 1958-61, XK150 3.8S 1958-61, Mark IX 1958-61, Mark X 3.8 1961-64, Mark II 1959-67, E-Type Series 1 3.8 1961-64, S-Type 3.8 1963-68

Head Gaskets

MLS Head Gaskets

Bore	Thickness	Pkg Qty	Part #	List Price
88mm	.040"	1	C4282-040	\$170.31
88.5mm	.050"	1	C14082-050	\$195.77
89mm	.040"	1	C4306-040	\$170.31

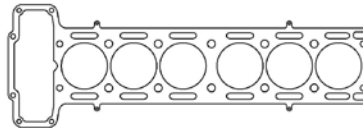

Additional thicknesses available see page 5

CFM-20 Head Gasket

Bore	Thickness	Pkg Qty	Part #	List Price
87mm	.059"	1	C4305-059	\$133.93
88mm	.059"	1	C14041-059	\$133.93
89mm	.059"	1	C4125-059	\$133.93

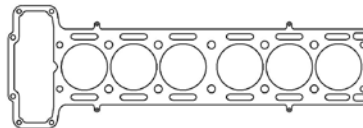

See page 102 for additional gaskets



JAGUAR

3.8L DOHC Inline 6 XK150 3.8 1958-61, XK150 3.8S 1958-61, Mark IX 1958-61, Mark X 3.8 1961-64, Mark II 1959-67, E-Type Series 1 3.8 1961-64, S-Type 3.8 1963-68

Individual Gaskets

Cam Cover Gasket Set		
Application	Part #	List Price
3.4/3.8/4.2L (Trim to Fit)	C4545-060	\$43.75

Oil Pan Gasket		
Application	Part #	List Price
3.4/3.8/4.2L .060" AFM	C4259-060	\$24.28

Intake Manifold Gaskets		
Application	Part #	List Price
3.8/4.2L Str Port Head	C4230-060	\$18.38
3.4/3.8L B Type Head	C4244-060	\$18.38

Engine Cover Gaskets		
Application	Part #	List Price
Front Main Seal Gasket	C4673-188	\$3.32
Rear Main Seal Gasket	C4901-188	\$3.32

Exhaust Manifold Gasket		
Application	Part #	List Price
3.4/3.8/4.2L	C4217-059	\$11.19

Timing Cover Gasket		
Application	Part #	List Price
3.4/3.8/E4.2L .018" AFM	C4336-018	\$19.79

Thermostat Gaskets		
Application	Part #	List Price
Series 1 1965-67	C4375-060	\$2.42
Series 2 1968-71	C4379-060	\$2.42

Engine Oil Gaskets		
Application	Part #	List Price
Oil Feed Gasket	C4949-032	\$2.42
Oil Filter Housing Gasket	C4179-032	\$3.65

Breather Cover Gasket Set		
Application	Part #	List Price
3.4/3.8/4.2L	C4544-060	\$7.30

Water Pump Gasket		
Application	Part #	List Price
3.4/3.8/E4.2L .018" AFM	C4337-018	\$6.23

4.0/4.2L AJ26/AJ26S/AJ27/AJ27S/AJ28/AJ33/AJ33S/AJ34/AJ34S V8 UK Engine

Head Gaskets

MLS Head Gasket - Left Side					
Bore	Thickness	Pkg Qty	Part #	List Price	
93mm	.030"	1	C4376-030	\$102.11	

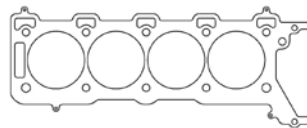

Additional thicknesses available see page 5

MLS Head Gasket - Right Side					
Bore	Thickness	Pkg Qty	Part #	List Price	
93mm	.030"	1	C4377-030	\$102.11	

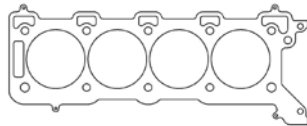

3.9L AJ30/AJ35 V8 US Engine

Head Gaskets

MLS Head Gaskets - Left Side					
Bore	Thickness	Pkg Qty	Part #	List Price	
87mm	.030"	1	C5772-030	\$104.70	
93mm	.030"	1	C5773-030	\$104.70	

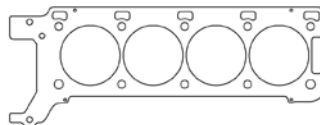

Additional thicknesses available see page 5

MLS Head Gaskets - Right Side					
Bore	Thickness	Pkg Qty	Part #	List Price	
87mm	.030"	1	C5770-030	\$104.70	
93mm	.030"	1	C5771-030	\$104.70	

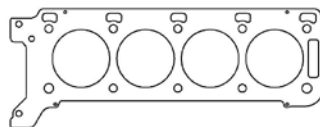



JAGUAR

4.2L Inline 6 Series 1 1965-67, Mark X 4.2 1964-66, 420 1966-68

Head Gaskets

CFM-20 Head Gasket				
Bore	Thickness	Pkg Qty	Part #	List Price
93mm	.059"	1	C4338-059	\$133.83

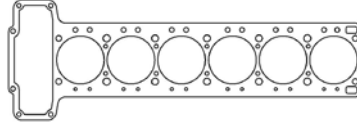

Additional thicknesses available
see page 5

Individual Gaskets

Cam Cover Gasket Set		
Application	Part #	List Price
3.4/3.8/4.2L (Trim to Fit)	C4545-060	\$43.75

Oil Pan Gasket		
Application	Part #	List Price
3.4/3.8/4.2L .060" AFM	C4259-060	\$24.28

Intake Manifold Gaskets		
Application	Part #	List Price
3.8/4.2L Str Port Head	C4230-060	\$18.38
3.4/3.8L B Type Head	C4244-060	\$18.38

Main Seal Gasket		
Application	Part #	List Price
Rear Main Seal Gasket	C4901-188	\$3.32

Exhaust Manifold Gasket		
Application	Part #	List Price
3.4/3.8/4.2L	C4217-059	\$11.19

Timing Cover Gasket		
Application	Part #	List Price
3.4/3.8/E4.2L .018" AFM	C4336-018	\$19.79

Thermostat Gaskets		
Application	Part #	List Price
Series 1 1965-67	C4375-060	\$2.42
Series 2 1968-71	C4379-060	\$2.42

Engine Oil Gaskets		
Application	Part #	List Price
Oil Feed Gasket	C4949-032	\$2.42
Oil Filter Housing Gasket	C4179-032	\$3.65

Breather Cover Gasket Set		
Application	Part #	List Price
3.4/3.8/4.2L	C4544-060	\$7.30

Water Pump Gasket		
Application	Part #	List Price
3.4/3.8/E4.2L .018" AFM	C4337-018	\$6.23

4.2L Inline 6 E-Type Series 2 1968-70, XJ6 4.2 Series 1 1968-73

Head Gaskets

CFM-20 Head Gasket				
Bore	Thickness	Pkg Qty	Part #	List Price
93mm	.059"	1	C4220-059	\$133.83

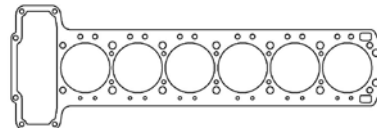

Additional thicknesses available
see page 5

Individual Gaskets

Cam Cover Gasket Set		
Application	Part #	List Price
3.4/3.8/4.2L (Trim to Fit)	C4545-060	\$43.75

Oil Pan Gasket		
Application	Part #	List Price
3.4/3.8/4.2L .060" AFM	C4259-060	\$24.28

Intake Manifold Gaskets		
Application	Part #	List Price
3.8/4.2L Str Port Head	C4230-060	\$18.38
3.4/3.8L B Type Head	C4244-060	\$18.38

Seal Gasket		
Application	Part #	List Price
Rear Main Seal Gasket	C4901-188	\$3.32

Exhaust Manifold Gasket		
Application	Part #	List Price
3.4/3.8/4.2L	C4217-059	\$11.19

Timing Cover Gasket		
Application	Part #	List Price
3.4/3.8/E4.2L .018" AFM	C4336-018	\$19.79
4.2L 1970+Up .018" AFM	C4902-018	\$19.79

See page 104 for additional gaskets



JAGUAR

4.2L Inline 6 E-Type Series 2 1968-70, XJ6 4.2 Series 1 1968-73

Individual Gaskets

Thermostat Gaskets

Application	Part #	List Price
Series 1 1965-67	C4375-060	\$2.42
Series 2 1968-71	C4379-060	\$2.42

Engine Oil Gaskets

Application	Part #	List Price
Oil Feed Gasket.....	C4949-032	\$2.42
Oil Filter Housing Gasket.....	C4179-032	\$3.65

Breather Cover Gasket Set

Application	Part #	List Price
3.4/3.8/4.2L.....	C4544-060	\$7.30

Water Pump Gasket

Application	Part #	List Price
3.4/3.8/E4.2L .018" AFM.....	C4337-018	\$6.23
4.2L 1970+Up .018" AFM	C4903-018	\$4.88

4.2L Hi-Performance Inline 6 XJ6 4.2 Series 3 1973-87

Head Gaskets

MLS Head Gaskets

Bore	Thickness	Pkg Qty	Part #	List Price
3.670"040"	1.....	C4128-040	\$231.04
3.690"040"	1.....	C4127-040	\$231.04

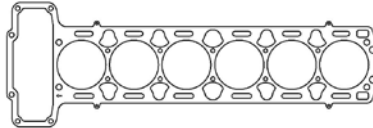

Additional thicknesses available
see page 5

Individual Gaskets

Cam Cover Gasket Set

Application	Part #	List Price
3.4/3.8/4.2L (Trim to Fit)	C4545-060	\$43.75

Oil Pan Gasket

Application	Part #	List Price
3.4/3.8/4.2L .060" AFM	C4259-060	\$24.28

Intake Manifold Gaskets

Application	Part #	List Price
3.8/4.2L Str Port Head.....	C4230-060	\$18.38
3.4/3.8L B Type Head.....	C4244-060	\$18.38

Main Seal Gasket

Application	Part #	List Price
Rear Main Seal Gasket	C4901-188	\$3.32

Exhaust Manifold Gasket

Application	Part #	List Price
3.4/3.8/4.2L.....	C4217-059	\$11.19

Timing Cover Gasket

Application	Part #	List Price
4.2L 1970+Up .018" AFM	C4902-018	\$19.79

Thermostat Gaskets

Application	Part #	List Price
Series 1 1965-67	C4375-060	\$2.42
Series 2 1968-71	C4379-060	\$2.42

Engine Oil Gaskets

Application	Part #	List Price
Oil Feed Gasket.....	C4949-032	\$2.42
Oil Filter Housing Gasket.....	C4179-032	\$3.65

Breather Cover Gasket Set

Application	Part #	List Price
3.4/3.8/4.2L.....	C4544-060	\$7.30

Water Pump Gasket

Application	Part #	List Price
4.2L 1970+Up .018" AFM	C4903-018	\$4.88

5.0L V8 Jaguar AJ133/Land Rover LR-V8: 2009+Up XF, XJ, XK, XFR, XJR, XKR, 2011+Up XKR-S, 2013+Up XFR-S, F-Type Convertible, 2014+Up F-Type Coupe

Head Gaskets

MLX Head Gasket - Left Side

Bore	Thickness	Pkg Qty	Part #	List Price
93mm040"	1.....	C15001-040	\$107.29

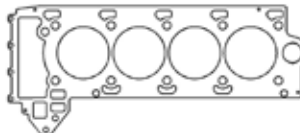

Additional thicknesses available
see page 5

See page 105 for additional gaskets



JAGUAR

5.0L V8 Jaguar AJ133/Land Rover LR-V8: 2009+Up XF, XJ, XK, XFR, XJR, XKR, 2011-Up XKR-S, 2013+Up XFR-S, F-Type Convertible, 2014+Up F-Type Coupe

MLX Head Gasket - Right Side				
Bore	Thickness	Pkg Qty	Part #	List Price
93mm	.040"	1	C15000-040	\$107.29

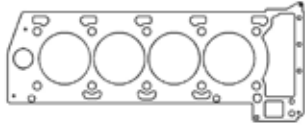

Additional thicknesses available see page 5

5.3L V12 1971-93

Head Gaskets

CFM-20 Head Gaskets - Left Side				
Bore	Thickness	Pkg Qty	Part #	List Price
93mm	.059"	1	C4330-059	\$133.83
97mm	.059"	1	C4221-059	\$133.83

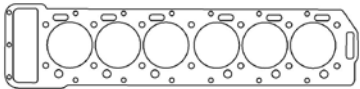

Additional thicknesses available see page 5

CFM-20 Head Gaskets - Right Side				
Bore	Thickness	Pkg Qty	Part #	List Price
93mm	.059"	1	C4331-059	\$133.83
97mm	.059"	1	C4222-059	\$133.83

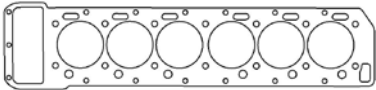

MAZDA

B6 1.6L DOHC 16V 1989-93 1597cc

Head Gaskets

MLS Head Gasket				
Bore	Thickness	Pkg Qty	Part #	List Price
80mm	.040"	1	C4122-040	\$109.42

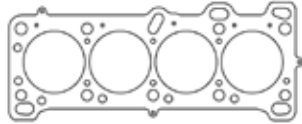

Additional thicknesses available see page 5

Individual Gaskets

Valve Cover Gasket Set		
Application	Part #	List Price
B6 1.6L 89-93	C4781	\$23.56

Rear Main Seal Set		
Application	Part #	List Price
B6 1.6L 89-93	C4783	\$13.27

Intake Manifold Gasket		
Application	Part #	List Price
B6 1.6L 89-93 .060" KF	C4779-060	\$12.42

Oil Pump Gasket Set		
Application	Part #	List Price
B6 1.6L 89-93	C4784	\$3.42

Exhaust Manifold Gasket		
Application	Part #	List Price
B6 1.6L 89-93 .030" MLS	C4165-030	\$33.65

Oil Pan Gasket Set		
Application	Part #	List Price
B6 1.6L 89-93 (Requires RTV)	C4785	\$11.02

Cam Seal Set		
Application	Part #	List Price
B6 1.6L 89-93 (2 Pack)	C4780	\$8.65

Water Pump Gasket		
Application	Part #	List Price
B6 1.6L 89-93	C4786	\$4.87

Valve Stem Seals (sold individually)		
Application	Part #	List Price
B6 1.6L 89-93	3169V	\$1.64

Thermostat Gasket		
Application	Part #	List Price
B6 1.6L 89-93 .046" Fiber	C4782-046	\$2.87

See page 106 for additional gaskets



MAZDA

B6 1.6L DOHC 16V 1989-93 1597cc

Gasket Kits



To purchase a complete gasket kit order both top end and bottom end gasket kit

TOP END GASKET KIT

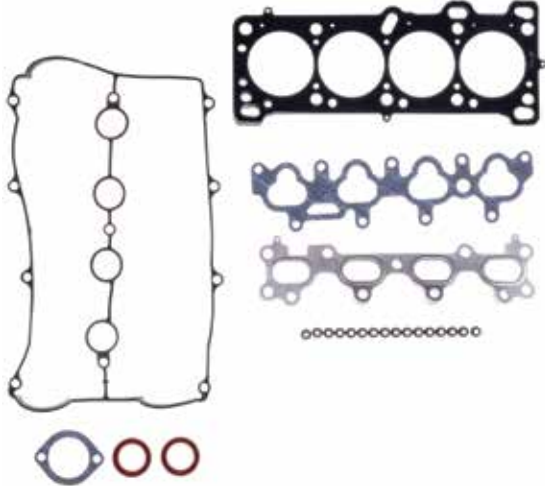

Application	Part #	List Price
B6 1.6L 89-93 80mm Bore	PRO2036T	\$181.76

BOTTOM END GASKET KIT



Application	Part #	List Price
B6 1.6L 89-93	PRO2036B	\$91.99

BP-ZE, BP-4W 1.8L DOHC 16V 1994-00 1839cc

Head Gaskets

MLS Head Gaskets

Bore	Thickness	Pkg Qty	Part #	List Price
83mm040"	1	C4560-040	\$109.42
84mm040"	1	C4568-040	\$109.42
85mm040"	1	C4569-040	\$109.42

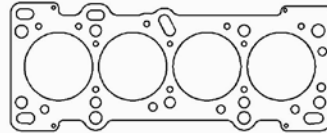

Additional thicknesses available see page 5

BP-Z3, BP-4W Turbo 1.8L DOHC 16V 2001-05 1839cc, 01-03 Miata, 04-05 Miata Mazdaspeed

Head Gaskets

MLS Head Gaskets

Bore	Thickness	Pkg Qty	Part #	List Price
84mm040"	1	C4983-040	\$109.42
85mm040"	1	C4984-040	\$109.42

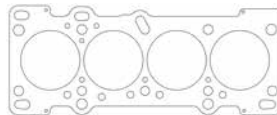

Additional thicknesses available see page 5



MAZDA

FS-DE 2.0L DOHC 16V 1993-03 1991cc 93-97 MX-5, 1999-06 Kia Carens, 93-97 Protegé

Head Gaskets

MLS Head Gaskets				
Bore	Thickness	Pkg Qty	Part #	List Price
84mm	.030"	1	C5844-030	\$114.86
84.5mm	.027"	1	C5845-027	\$114.86

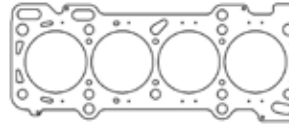

Additional thicknesses available see page 5

Individual Gaskets

Valve Cover Gasket Set		
Application	Part #	List Price
FS-DE 2.0L DOHC	C4788	\$29.44

Oil Pan Gasket Set		
Application	Part #	List Price
FS-DE 2.0L DOHC	C4790-062	\$5.05

Intake Manifold Gasket		
Application	Part #	List Price
FS-DE 2.0L DOHC	C4787-046	\$10.88

Rear Main Seal Set		
Application	Part #	List Price
FS-DE 2.0L DOHC	C4791	\$25.25

Exhaust Manifold Gasket		
Application	Part #	List Price
FS-DE 2.0L DOHC .030" MLS	C4171-030	\$28.07

Water Pump Gasket		
Application	Part #	List Price
FS-DE 2.0L DOHC	C4792-031	\$10.25

Cam Seal Set		
Application	Part #	List Price
FS-DE 2.0L DOHC (2 Pack)	C4780	\$8.65

Thermostat Gasket Kit		
Application	Part #	List Price
FS-DE 2.0L DOHC	C4789	\$9.59

Valve Stem Seals (sold individually)		
Application	Part #	List Price
FS-DE 2.0L DOHC	3225V	\$1.75

Gasket Kits



To purchase a complete gasket kit order both top end and bottom end gasket kit

TOP END GASKET KIT



Application	Part #	List Price
FS-DE 2.0L DOHC 93-03 84mm Bore	PRO2037T	\$170.39

BOTTOM END GASKET KIT



Application	Part #	List Price
FS-DE 2.0L DOHC 93-03	PRO2037B	\$42.00



MAZDA

MZR 2.3L DOHC 16V 2261cc 2006-13

Head Gasket

MLS Head Gasket					
Bore	Thickness	Pkg Qty	Part #	List Price	
89mm030"1	C4481-030	\$102.16	

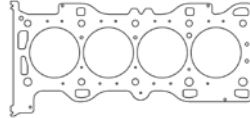

Additional thicknesses available see page 5

MLX Head Gasket					
Bore	Thickness	Pkg Qty	Part #	List Price	
89mm028"1	C4970-028	\$141.78	

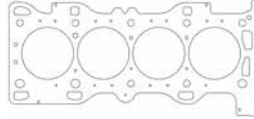

Timing Cover Gasket

Timing Cover Gasket			Part #	List Price
Application				
2006-08 MZR 2.3L			C14028	\$31.98

MZR 2.5L DISI DOHC 16V 2488cc 2009

Head Gasket

MLS Head Gasket					
Bore	Thickness	Pkg Qty	Part #	List Price	
90mm040"1	C5906-040	\$102.16	

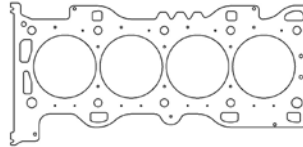

Additional thicknesses available see page 5

MERCEDES BENZ

Mercedes-Benz 6.0L M120; 6.9/7.0L M297 V12: 1992-02 600SEC, 600SEL, 600SL, 1997 CLK-GTR

Head Gaskets

MLS Head Gasket - Left Side					
Bore	Thickness	Pkg Qty	Part #	List Price	
90mm051"1	C4501-051	\$347.79	

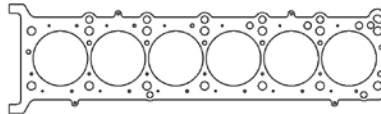

Additional thicknesses available see page 5

MLS Head Gasket - Right Side					
Bore	Thickness	Pkg Qty	Part #	List Price	
90mm051"1	C4500-051	\$347.79	

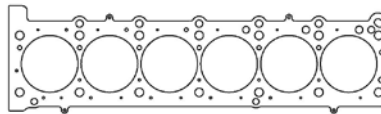

Mercedes-Benz 7.3L M120/M297 V12: 99-10 Pagani Zonda, 99-05 AMG SL73

Head Gaskets

MLS Head Gasket - Left Side					
Bore	Thickness	Pkg Qty	Part #	List Price	
91.5mm051"1	C4504-051	\$347.79	

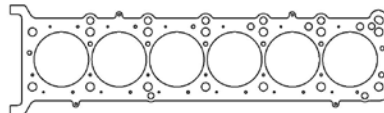

Additional thicknesses available see page 5

MLS Head Gasket - Right Side					
Bore	Thickness	Pkg Qty	Part #	List Price	
91.5mm051"1	C4503-051	\$347.79	

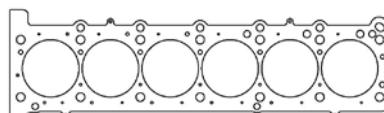



MG

Midget 1275cc Austin Series A

Head Gasket

MLS Head Gasket

Bore	Thickness	Pkg Qty	Part #	List Price
74mm	.040"	1	C4148-040	\$97.27

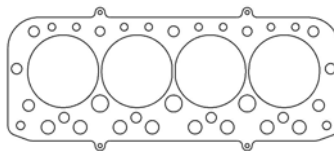

Additional thicknesses available
see page 5

MGA1500 / 1600 / 1600 MKII Series B

Head Gasket

MLS Head Gasket

Bore	Thickness	Pkg Qty	Part #	List Price
74mm	.040"	1	C4359-040	\$97.27

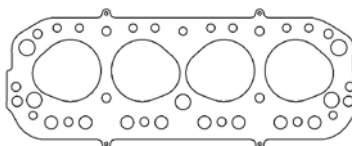

Additional thicknesses available
see page 5

MGB 1.8L 18G / 18GA

Head Gasket

MLS Head Gasket

Bore	Thickness	Pkg Qty	Part #	List Price
83mm	.040"	1	C4147-040	\$97.27

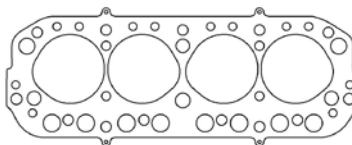

Additional thicknesses available
see page 5

MINI

1.6L Tritec/Pentagon 1999-06

Head Gasket

MLS Head Gasket

Bore	Thickness	Pkg Qty	Part #	List Price
78.5mm	.027"	1	C4308-027	\$97.27

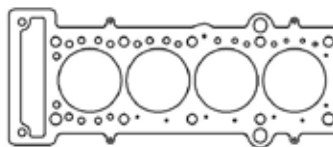

Additional thicknesses available
see page 5

1.6L Turbo Prince / N14B16C / N14B16A / N18B16A / N18B16C 2007-13

Head Gasket

MLX Head Gasket

Bore	Thickness	Pkg Qty	Part #	List Price
78mm	.032"	1	C4617-032	\$97.27
78mm	.036"	1	C4617-036	\$97.27
78mm	.040"	1	C4617-040	\$97.27

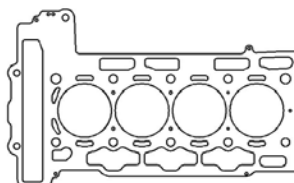

Additional thicknesses available
see page 5



MITSUBISHI

2.0L 4G63/4G63-T DOHC: Eclipse 90-99, EVO 1-3 92-95

Head Gaskets

MLS Head Gaskets

Bore	Thickness	Pkg Qty	Part #	List Price
85.5mm	.051"	1	C4233-051	\$97.27
86mm	.051"	1	C4234-051	\$97.27
87mm	.051"	1	C4235-051	\$97.27

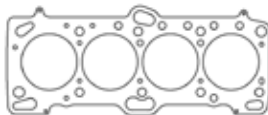

Additional thicknesses available
see page 5

MLX Head Gasket

Bore	Thickness	Pkg Qty	Part #	List Price
87mm	.050"	1	C4957-050	\$120.47

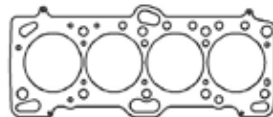

Individual Gaskets

Valve Cover Gasket Set

Application	Part #	List Price
4G63/T 89-94	C4691	\$40.05

Throttle Body Gaskets

Application	Part #	List Price
4G63/T 91-94	C4693	\$5.96
4G63/T 95-97	C4904	\$5.96

Intake Manifold Gasket

Application	Part #	List Price
4G63/T 89-94	C4692-060	\$16.58

Oil Pan Gaskets

Application	Part #	List Price
4G63/T 89-92	C4695	\$14.94
4G63/T 93-94	C4698	\$6.58

Exhaust Manifold Gasket

Application	Part #	List Price
4G63/T 89-94 .030" MLS	C4199-030	\$24.69

Water Pump Gasket Set

Application	Part #	List Price
4G63/T 89-94	C4696	\$11.43

Cam Seal Set

Application	Part #	List Price
4G63/T 89-94 (2 Pack)	C4905	\$21.68

Rear Main Seal Set

Application	Part #	List Price
4G63/T 89-92	C4697	\$24.18
4G63/T 93-94	C4699	\$13.59

Valve Stem Seals (sold individually)

Application	Part #	List Price
4G63/T 89-94	3173V	\$2.08

Thermostat Gasket Set

Application	Part #	List Price
4G63/T 89-94	C4694	\$12.47

Gasket Kits



To purchase a complete gasket kit order both top end and bottom end gasket kit

TOP END GASKET KIT

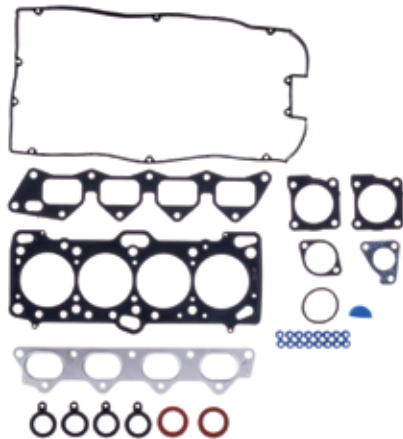

Application	Part #	List Price
4G63/T 89-94 84mm Bore	PRO2006T	\$204.70

BOTTOM END GASKET KITS



Application	Part #	List Price
4G63/T 89-92	PRO2006B	\$85.18
4G63/T 93-94	PRO2007B	\$53.35



MITSUBISHI

2.0L 4G63 / 4G63-T DOHC:EVO 4-8 1996-05

Head Gaskets

MLS Head Gaskets				
Bore	Thickness	Pkg Qty	Part #	List Price
85mm	.051"	1	C4157-051	\$97.27
86mm	.051"	1	C4156-051	\$97.27
87mm	.051"	1	C4591-051	\$97.27

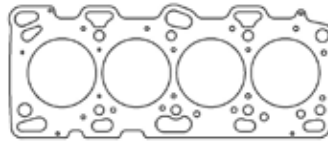

Additional thicknesses available see page 5

MLX Head Gasket				
Bore	Thickness	Pkg Qty	Part #	List Price
87mm	.032"	1	C4956-032	\$100.57
87mm	.044"	1	C4956-050	\$120.47
87mm	.050"	1	C4956-050	\$120.47

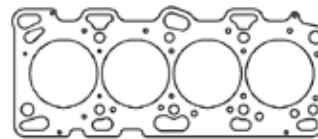

Individual Gaskets

Exhaust Manifold Gasket		
Application	Part #	List Price
96-06 Evolution	C4199-030	\$24.69

2.0L DOHC 4cyl ECC/420A 1995-99

Head Gaskets

MLS Head Gaskets				
Bore	Thickness	Pkg Qty	Part #	List Price
87.5mm	.040"	1	C5497-040	\$93.07
88.5mm	.040"	1	C5498-040	\$93.07

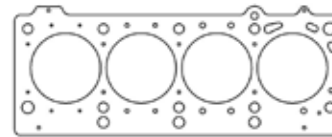

Additional thicknesses available see page 5

Individual Gaskets

Valve Cover Gasket Set		
Application	Part #	List Price
1995-99 2.0L DOHC	C15046	\$23.56

Cam Seal Set		
Application	Part #	List Price
Pair - 48 x 35 x 7	C15049	\$13.96

Intake Manifold Gaskets		
Application	Part #	List Price
Intake Manifold Gasket - .060" AFM	C15047-060	\$11.87
Intake Plenum Gasket - .031" Fiber	C15048-031	\$4.90

Front Crank Seal Set		
Application	Part #	List Price
1995-99 2.0L DOHC	C15053	\$21.41

Exhaust Manifold Gasket		
Application	Part #	List Price
2.040" X 1.100" Port - MLS	C4161-030	\$24.69

Oil Pan Gasket		
Application	Part #	List Price
Molded Rubber	C15050	\$29.69

Throttle Body Gasket		
Application	Part #	List Price
Molded Rubber	C15051	\$3.75

Rear Main Seal		
Application	Part #	List Price
1995-99 2.0L DOHC	C15052	\$13.67

Valve Stem Seals Set (16 Pack)		
Application	Part #	List Price
5 x 10.8 x 18.3 x 16.9 - Hat Style	3180V-16	\$33.79

See page 112 for StreetPro gasket kits



MITSUBISHI

2.0L DOHC 4cyl ECC/420A 1995-99

Gasket Kits



To purchase a complete gasket kit order both top end and bottom end gasket kit

TOP END GASKET KIT

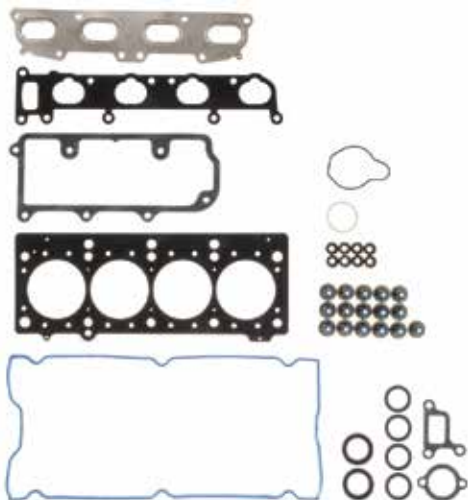

Application	Part #	List Price
1995-99 420A 2.0L DOHC 88.5mm Bore	PRO2005T	\$159.03

BOTTOM END GASKET KIT



Application	Part #	List Price
1995-99 420A 2.0L DOHC	PRO2005B	\$76.08

2.0L 4B11T Turbo 2007+: EVO X 2007-15

Head Gaskets

MLX Head Gaskets

Bore	Thickness	Pkg Qty	Part #	List Price
88mm044"1	C4483-044	\$120.47
90mm044"1	C4484-044	\$120.47

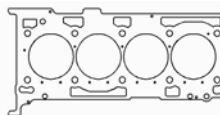

Additional thicknesses available
see page 5

3.0L 6G72 SOHC/DOHC 24v V6 1988-00

Head Gaskets

MLS Head Gaskets

Bore	Thickness	Pkg Qty	Part #	List Price
93mm051"1	C4243-051	\$97.27
95mm051"1	C4240-051	\$97.27

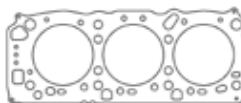

Additional thicknesses available
see page 5

Individual Gaskets

Valve Cover Gasket Sets

Application	Part #	List Price
1988-96 3.0L V6 SOHC	C4713	\$62.39
1991-00 3.0L V6 DOHC	C4722	\$47.12

Oil Pan Gaskets

Application	Part #	List Price
1988-96 3.0L V6 SOHC	C4717	\$5.50
1991-00 3.0L V6 DOHC	C4727	\$5.35

Intake Manifold Gasket Sets

Application	Part #	List Price
1988-96 3.0L V6 SOHC	C4714	\$28.44
1991-00 3.0L V6 DOHC	C4723	\$50.47

Water Pump Gasket Sets

Application	Part #	List Price
1988-96 3.0L V6 SOHC	C4719	\$10.52
1991-00 3.0L V6 DOHC	C4728-020	\$4.95

Exhaust Manifold Gasket Sets

Application	Part #	List Price
1988-96 3.0L V6 SOHC	C4715-042	\$53.46
1991-00 3.0L V6 DOHC	C4724-064	\$53.46

Rear Main Seal Set

Application	Part #	List Price
1988-00 3.0L V6 SOHC/DOHC	C4720	\$15.18



MITSUBISHI

3.0L 6G72 SOHC/DOHC 24v V6 1988-00

Individual Gaskets

Cam Seal Sets		
Application	Part #	List Price
1988-96 3.0L V6 SOHC (2)	C4905	\$21.68
1991-00 3.0L V6 DOHC (4)	C4725	\$18.90

Oil Pump Gasket Kits		
Application	Part #	List Price
1988-96 3.0L V6 SOHC	C4721	\$7.29
1991-00 3.0L V6 DOHC	C4729	\$8.37

Valve Stem Seals (sold individually)		
Application	Part #	List Price
1988-96 3.0L V6 SOHC	3157V	\$1.86
1991-00 3.0L V6 DOHC	3173V	\$2.08

Thermostat Gaskets		
Application	Part #	List Price
1988-96 3.0L V6 SOHC	C4716-032	\$7.29
1991-00 3.0L V6 DOHC	C4726	\$2.87

Gasket Kits



To purchase a complete gasket kit order both top end and bottom end gasket kit

TOP END GASKET KITS



Application	Part #	List Price
1988-96 3.0L V6 SOHC 93mm Bore	PRO2038T	\$296.52
1991-00 3.0L V6 DOHC 93mm Bore	PRO2039T	\$418.11

BOTTOM END GASKET KITS



Application	Part #	List Price
1988-96 3.0L V6 SOHC	PRO2038B	\$45.40
1991-00 3.0L V6 DOHC	PRO2039B	\$36.71

NISSAN

1.5L E15, E15S, E15T SOHC Pulsar 1980-86, Ninja Gayin 1984-94, Sunny 1980-86

Head Gasket

MLS Head Gasket				
Bore	Thickness	Pkg Qty	Part #	List Price
77mm	.040"	1	C4178-040	\$97.27



Additional thicknesses available see page 5

Individual Gaskets

Valve Cover Gasket Set		
Application	Part #	List Price
E15T 1983-84	C4906	\$17.66

Cam Seal		
Application	Part #	List Price
E15T 1983-84	C4910	\$4.56

Intake Manifold Gasket		
Application	Part #	List Price
E15T 1983-84	C4907	\$11.29

Rear Main Seal Set		
Application	Part #	List Price
E15T 1983-84	C4763	\$14.57

See page 114 for additional gaskets



NISSAN

1.5L E15, E15S, E15T SOHC Pulsar 1980-86, Ninja Gayin 1984-94, Sunny 1980-86

Individual Gaskets

Exhaust Manifold Gaskets

Application	Part #	List Price
1982-83 E15S SOHC	C4908	\$13.76
1983-84 E15T SOHC	C4909	\$25.21

Front Crank Set

Application	Part #	List Price
E15T 1983-84	C4912	\$30.36

Valve Stem Seals (sold individually)

Application	Part #	List Price
E15T 1983-84	3159V	\$1.38

Water Pump Gasket Set

Application	Part #	List Price
E15T 1983-84	C4913	\$2.34

1.6L MR16DDT Juke 2011-2017, 2017-Present Sentra SR Turbo & NISMO

Head Gasket

MLS Head Gasket

Bore	Thickness	Pkg Qty	Part #	List Price
81mm032"	1	C4965-032	\$120.47

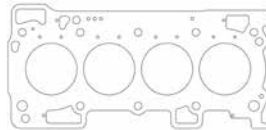

Additional thicknesses available
see page 5

1.8L CA18 SOHC Skyline R31 1988-90, Skyline R32 GXi 1988-90, Skyline HR31 1985-91, Silvia Turbo 1984-89, 180SX 1981-83, 200SX 1984-88, Bluebird Turbo 1991-93, Bluebird 1983-85, 200SX Turbo 1984-87, Pulsar 1981-83, Sunny 1988-91

Head Gaskets

MLS Head Gasket

Bore	Thickness	Pkg Qty	Part #	List Price
85mm051"	1	C4479-051	\$112.74

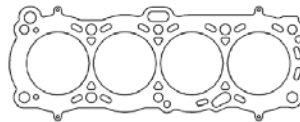

Additional thicknesses available
see page 5

1.8L CA18 DOHC Skyline HR31 1985-91, Silvia Turbo 1989-90, 180SX P/S13 1989-90, 200SX S13-U 1989-93, Bluebird Turbo 1987-89, Bluebird 1987-89, 200SX Turbo 1989-93, Pulsar, Sunny N13/B12 Coupe mid 80s

Head Gaskets

MLS Head Gasket

Bore	Thickness	Pkg Qty	Part #	List Price
85mm051"	1	C4480-051	\$112.74

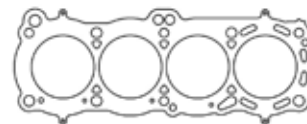

Additional thicknesses available
see page 5

Individual Gaskets

Valve Cover Gasket Set

Application	Part #	List Price
CA18DE/DET 1.8L	C4607	\$23.56

Throttle Body Gaskets

Application	Part #	List Price
CA18DE/DET 1.8L (pair)	C4740-032	\$6.18

Intake Manifold Gasket Set

Application	Part #	List Price
CA18DE/DET 1.8L	C4742	\$35.36

Rear Main Seal Set

Application	Part #	List Price
CA18DE/DET 1.8L	C4737	\$16.87

Exhaust Manifold Gasket Set

Application	Part #	List Price
CA18DE/DET 1.8L MLS 4pcs	C4523	\$34.86

Water Pump Gasket

Application	Part #	List Price
CA18DE/DET 1.8L	C4736-018	\$6.29

See page 115 for additional gaskets



NISSAN

1.8L CA18 DOHC: Skyline HR31 1985-91, Silvia Turbo 1989-90, 180SX P/S13 1989-90, 200SX S13-U 1989-93, Bluebird Turbo 1987-89, Bluebird 1987-89, 200SX Turbo 1989-93, Pulsar, Sunny N13/B12 Coupe mid 80s

Individual Gaskets

Cam Seal Set		
Application	Part #	List Price
CA18DE/DET 1.8L (pair)	C4739	\$9.21

Oil Pump Gasket		
Application	Part #	List Price
CA18DE/DET 1.8L	C4738-020	\$5.12

Valve Stem Seals (sold individually)		
Application	Part #	List Price
CA18DE/DET 1.8L	3175V	\$1.47

Front Crank Seal		
Application	Part #	List Price
CA18DE/DET 1.8L	C4914	\$4.61

Gasket Kits

To purchase a complete gasket kit order both top end and bottom end gasket kit

TOP END GASKET KIT

Application	Part #	List Price
CA18DE/DET 1.8L 85mm Bore	PRO2018T	\$224.94

BOTTOM END GASKET KIT

Application	Part #	List Price
CA18DE/DET 1.8L	PRO2018B	\$49.94

2.0L FJ20E/ET 240RS 1983-85, Skyline DR30 1983-85, Silvia 1983-85

Head Gaskets

MLS Head Gaskets				
Bore	Thickness	Pkg Qty	Part #	List Price
90mm	.051"	1	C4326-051	\$109.42
91mm	.051"	1	C4327-051	\$109.42

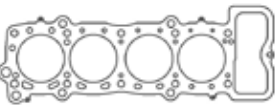

Additional thicknesses available see page 5

1.6L SR16VE/2.0L SR20VE DOHC 1997-01 Pulsar, Lucino, Primera, Bluebird, Wingroad, Sunny

Head Gasket

MLS Head Gaskets				
Bore	Thickness	Pkg Qty	Part #	List Price
87mm	.040"	1	C4600-040	\$97.27
88mm	.040"	1	C4601-040	\$97.27



Additional thicknesses available see page 5

Individual Gaskets

Valve Cover Gasket Set		
Application	Part #	List Price
SR16VE/SR20VE	C4730	\$41.23

Throttle Body Gasket		
Application	Part #	List Price
SR16VE/SR20VE	C4733-018	\$3.09

See page 116 for additional gaskets



NISSAN

1.6L SR16VE/2.0L SR20VE DOHC Pulsar, Lucino, Primera, Bluebird, Wingroad, Sunny 1997-01

Individual Gaskets

Intake Manifold Gasket Set		
Application	Part #	List Price
SR16VE/SR20VE	C4731	\$35.33

Rear Main Seal		
Application	Part #	List Price
SR16VE/SR20VE	C4734	\$13.27

Exhaust Manifold Gasket Set		
Application	Part #	List Price
SR16VE/SR20VE	C4732-064	\$13.49
SR16VE/SR20VE MLS	C4995-030	\$30.37

Oil Pump Gasket		
Application	Part #	List Price
SR16VE/SR20VE	C4735-020	\$1.08

Valve Stem Seals (sold individually)		
Application	Part #	List Price
SR16VE/SR20VE	3175V	\$1.47

Front Crank Seal		
Application	Part #	List Price
SR16VE/SR20VE	C4915	\$5.51

Gasket Kits



To purchase a complete gasket kit order both top end and bottom end gasket kit

TOP END GASKET KIT



Application	Part #	List Price
SR16VE/SR20VE 88mm Bore	PRO2053T	\$222.66

BOTTOM END GASKET KIT



Application	Part #	List Price
SR16VE/SR20VE	PRO2053B	\$33.30

2.0L SR20DE/DET DOHC FWD 180SX 1991-92/1994-97, 200SX SE-R 1995-98, Almera 1996-98, Avenir 1990/92/1995/97-01, Bluebird 1989/91-1993/95-98, Liberty 1998-00, Infinity G20 1991-02, NX2000 1991-93, Pulsar 1991-00, Sentra 1991-94/98-01

Head Gaskets

MLS Head Gaskets				
Bore	Thickness	Pkg Qty	Part #	List Price
87mm030"	1	C4575-030	\$97.27
88.5mm030"	1	C4130-030	\$97.27



Additional thicknesses available see page 5

Individual Gaskets

Valve Cover Gasket Sets		
Application	Part #	List Price
SR20DE/DET FWD 91-96	C4747	\$29.44
SR20DE/DET FWD 97-01	C4730	\$41.23

Thermostat Gasket Set		
Application	Part #	List Price
SR20DE/DET FWD 91-01	C4916	\$6.47

See page 117 for additional gaskets



NISSAN

2.0L SR20DE/DET DOHC FWD
 91-92/94-97 180SX, 95-98 200SX SE-R, 96-98 Almera, 90/92-95/97-01 Avenir,
 89/91-93/95-98 Bluebird, 98-00 Liberty,
 91-02 Infinity G20, 91-93 NX2000, 91-00 Pulsar, 91-94/98-01 Sentra

Individual Gaskets

Intake Manifold Gaskets		
Application	Part #	List Price
SR20DE/DET FWD 91-93	C4746	\$7.87
SR20DE/DET FWD 94-01	C4749	\$20.89

Oil Pan Gasket		
Application	Part #	List Price
SR20DE/DET FWD 91-01	C4744-156	\$24.23

Exhaust Manifold Gasket Set		
Application	Part #	List Price
SR20DE/DET FWD 91-01 MLS	C4200-030	\$30.32

Water Pump Gasket		
Application	Part #	List Price
SR20DE/DET FWD 91-01	C4745-031	\$3.33

Throttle Body Gasket		
Application	Part #	List Price
SR20DE/DET FWD 91-01	C4733-018	\$3.09

Oil Pump Gasket		
Application	Part #	List Price
SR20DE/DET FWD 91-01	C4743	\$15.75

Valve Stem Seals (sold individually)		
Application	Part #	List Price
SR20DE/DET FWD 91-01	3175V	\$1.47

Front Crank Seal		
Application	Part #	List Price
SR20DE/DET FWD 91-01	C4915	\$5.51

Gasket Kits

To purchase a complete gasket kit order both top end and bottom end gasket kit

TOP END GASKET KIT

Application	Part #	List Price
SR20DE/DET FWD 91-96 87mm Bore	PRO2012T	\$193.12
SR20DE/DET FWD 97-01 87mm Bore	PRO2011T	\$193.12

BOTTOM END GASKET KIT

Application	Part #	List Price
SR20DE/DET FWD 91-01	PRO2012B	\$53.35

2.0L SR20DE/DET DOHC S13 1989-93

Head Gasket

MLS Head Gasket				
Bore	Thickness	Pkg Qty	Part #	List Price
87.5mm045"	1	C4324-045	\$97.27

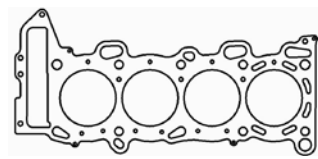

Additional thicknesses available see page 5



NISSAN

2.0L SR20DE/DET DOHC S13 1989-93

Individual Gaskets

Valve Cover Gasket Set

Application	Part #	List Price
SR20DE/DET S13 89-93.....	C4753	\$23.56

Intake Manifold Gasket Set

Application	Part #	List Price
SR20DE/DET S13 89-93.....	C4752	\$13.69

Exhaust Manifold Gasket Set

Application	Part #	List Price
SR20DE/DET S13 89-93 MLS	C4200-030	\$30.32

Valve Stem Seals (sold individually)

Application	Part #	List Price
SR20DE/DET S13 - EXH	3158V	\$1.38
SR20DE/DET S13 - INT	3175V	\$1.47

Throttle Body Gasket

Application	Part #	List Price
SR20DE/DET S13 89-93.....	C4733-018	\$3.09

Thermostat Gasket Set

Application	Part #	List Price
SR20DE/DET S13 89-93.....	C4758	\$4.22

Rear Main Seal Set

Application	Part #	List Price
SR20DE/DET S13 89-93.....	C4743	\$15.75

Front Crank Seal

Application	Part #	List Price
SR20DE/DET S13 89-93.....	C4915	\$5.51

Gasket Kits



To purchase a complete gasket kit order both top end and bottom end gasket kit

TOP END GASKET KIT



Application	Part #	List Price
SR20DE/DET S13 w/o VC Set 87.5mm Bore ..	PRO2008T	\$193.12
SR20DE/DET S13 89-93 88mm Bore	PRO2053T	\$222.66

BOTTOM END GASKET KIT



Application	Part #	List Price
SR20DE/DET S13 89-93.....	PRO2010B	\$53.35

2.0L SR20DE/DET DOHC S14/S15 1994-02

Head Gaskets

MLS Head Gaskets

Bore	Thickness	Pkg Qty	Part #	List Price
86mm051"	1.....	C14052-051	\$97.27
87mm040"	1.....	C14056-040	\$97.27
87mm051"	1.....	C14056-051	\$97.27
87.5mm.....	.045"	1.....	C4576-045	\$97.27
88.5mm.....	.045"	1.....	C4283-045	\$97.27

MLX Head Gaskets

Bore	Thickness	Pkg Qty	Part #	List Price
87mm040"	1.....	C4950-040	\$124.78
88mm040"	1.....	C4951-040	\$124.78

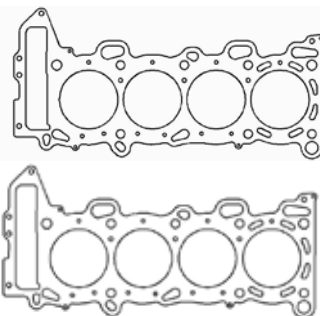

Additional thicknesses available see page 5



NISSAN

2.0L SR20DE/DET DOHC S14 1994-98

Individual Gaskets

Valve Cover Gasket Set		
Application	Part #	List Price
SR20DE/DET S14 94-96.....	C4755	\$23.56

Throttle Body Gasket		
Application	Part #	List Price
SR20DE/DET S14 94-96.....	C4754-032	\$3.32

Intake Manifold Gasket Set		
Application	Part #	List Price
SR20DE/DET S14 94-96.....	C4749	\$20.89

Thermostat Gasket Set		
Application	Part #	List Price
SR20DE/DET S14 94-96.....	C4758	\$4.22

Exhaust Manifold Gasket Set		
Application	Part #	List Price
SR20DE/DET S14 94-96 MLS	C4200-030	\$30.32

Rear Main Seal Set		
Application	Part #	List Price
SR20DE/DET S14 94-96.....	C4743	\$15.75

Valve Stem Seals (sold individually)		
Application	Part #	List Price
SR20DE/DET S14 - EXH	3158V	\$1.38
SR20DE/DET S14 - INT	3175V	\$1.47

Front Crank Seal		
Application	Part #	List Price
SR20DE/DET S14 94-96.....	C4915	\$5.51

Gasket Kit



To purchase a complete gasket kit order both top end and bottom end gasket kit

TOP END GASKET KIT

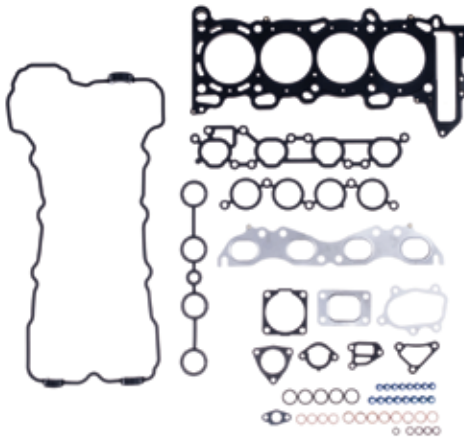

Application	Part #	List Price
SR20DE/DET S14 94-96 87.5mm Bore	PRO2009T	\$193.12

BOTTOM END GASKET KIT



Application	Part #	List Price
SR20DE/DET S14 94-96.....	PRO2010B	\$53.35

2.0L SR20DE/DET DOHC GTiR RNN14 AWD 1990-94

Head Gaskets

MLS Head Gaskets				
Bore	Thickness	Pkg Qty	Part #	List Price
87.5mm040"	1	C4543-040	\$97.27
88mm.....	.040"	1	C4577-040	\$97.27

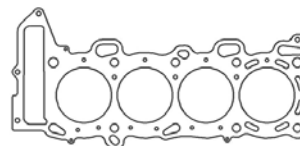

Additional thicknesses available see page 5

Individual Gaskets

Valve Cover Gasket Set		
Application	Part #	List Price
SR20DE/DET GTiR RNN14	C4747	\$29.44

Throttle Body Gasket		
Application	Part #	List Price
SR20DE/DET GTiR RNN14	C4756-018	\$11.92

See page 120 for additional gaskets



NISSAN

2.0L SR20DE/DET DOHC GTiR RNN14 AWD 1990-94

Individual Gaskets

Intake Manifold Gasket Set		
Application	Part #	List Price
SR20DE/DET GTiR RNN14	C4757-018	\$14.11

Thermostat Gasket Set		
Application	Part #	List Price
SR20DE/DET GTiR RNN14	C4758	\$4.22

Exhaust Manifold Gasket Set		
Application	Part #	List Price
SR20DE/DET GTiR RNN14 MLS	C4200-030	\$30.32

Rear Main Seal Set		
Application	Part #	List Price
SR20DE/DET GTiR RNN14	C4743	\$15.75

Valve Stem Seals (sold individually)		
Application	Part #	List Price
SR20DE/DET GTiR - EXH.....	3158V	\$1.38
SR20DE/DET GTiR - INT	3175V	\$1.47

Front Crank Seal		
Application	Part #	List Price
SR20DE/DET GTiR RNN14	C4915	\$5.51

Gasket Kits



To purchase a complete gasket kit order both top end and bottom end gasket kit

TOP END GASKET KIT



Application	Part #	List Price
SR20DE/DET GTiR RNN14 87.5mm Bore.....	PRO2010T	\$193.12

BOTTOM END GASKET KIT



Application	Part #	List Price
SR20DE/DET GTiR RNN14	PRO2010B	\$53.35

2.0L RB20E/DE/DET Inline 6 Laurel 1988-93, Skyline R32 1988-93, Cefio 1988-93

Head Gaskets

MLS Head Gaskets - RB20DE/RB20DET				
Bore	Thickness	Pkg Qty	Part #	List Price
80mm040"	1	C4495-040	\$182.40
80mm051"	1	C4495-051	\$182.40

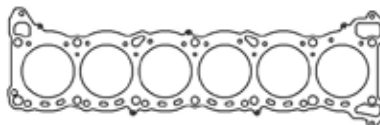

Additional thicknesses available see page 5

Individual Gaskets

Valve Cover Gasket Set		
Application	Part #	List Price
RB20E/DE/DET 88-93.....	C4552	\$35.34

Throttle Body Gasket		
Application	Part #	List Price
RB20E/DE/DET 88-93.....	C4733-018	\$3.09

Intake Manifold Gasket Set		
Application	Part #	List Price
RB20E/DE/DET 88-93.....	C4759	\$51.47

Rear Main Seal		
Application	Part #	List Price
RB20E/DE/DET 88-93.....	C4770	\$13.40

See page 121 for additional gaskets



NISSAN

2.0L RB20E/DE/DET Inline 6 Laurel 1988-93, Skyline R32 1988-93, Cefio 1988-93

Individual Gaskets

Exhaust Manifold Gasket		
Application	Part #	List Price
RB20E/DE/DET 88-93 MLS	C4177-030	\$28.07

Oil Pump Gasket		
Application	Part #	List Price
RB20E/DE/DET 88-93	C4769-020	\$7.71

Cam Seal Set		
Application	Part #	List Price
RB20E/DE/DET 88-93 (pair)	C4739	\$9.21

Front Crank Seal		
Application	Part #	List Price
RB20E/DE/DET 88-93	C4914	\$4.61

Valve Stem Seals (sold individually)		
Application	Part #	List Price
RB20E/DE/DET 88-93	3175V	\$1.47

Oil Pan Gasket		
Application	Part #	List Price
RB20E/DE/DET 88-93	C14117-094	\$61.65

Gasket Kits

To purchase a complete gasket kit order both top end and bottom end gasket kit

TOP END GASKET KIT

Application	Part #	List Price
RB20E/DE/DET 88-93 80mm Bore	PRO2015T	\$255.62

BOTTOM END GASKET KIT

Application	Part #	List Price
RB20E/DE/DET 88-93	PRO2017B	\$53.35

2.4L KA24DE DOHC: 1991-98 240SX

Head Gaskets

MLS Head Gaskets				
Bore	Thickness	Pkg Qty	Part #	List Price
90mm040"	1	C4285-040	\$97.27
91mm040"	1	C4286-040	\$97.27

Additional thicknesses available
see page 5

Individual Gaskets

Valve Cover Gasket Sets		
Application	Part #	List Price
KA24DE 1991-94	C4761	\$23.56
KA24DE 1995-98	C4766	\$23.56

Oil Pan Gasket		
Application	Part #	List Price
KA24DE 1991-98	C4764-060	\$12.82

Intake Manifold Gasket Set		
Application	Part #	List Price
KA24DE 1991-98	C4760	\$19.78

Water Pump Gasket		
Application	Part #	List Price
KA24DE 1991-98	C4765-031	\$3.37

See page 122 for additional gaskets



NISSAN

2.4L KA24DE DOHC: 1991-98 240SX

Individual Gaskets

Exhaust Manifold Gasket		
Application	Part #	List Price
KA24DE 1991-98 MLS	C4201-030	\$30.32

Rear Main Seal Set		
Application	Part #	List Price
KA24DE 1991-98.....	C4763	\$14.57

Throttle Body Gasket		
Application	Part #	List Price
KA24DE 1991-98.....	C4733-018	\$3.09

Thermostat Gasket Set		
Application	Part #	List Price
KA24DE 1991-98.....	C4762	\$3.96

Valve Stem Seals (sold individually)		
Application	Part #	List Price
KA24DE 1991-98.....	3158V	\$1.38

Front Crank Seal		
Application	Part #	List Price
KA24DE 1991-98.....	C4915	\$5.51

Gasket Kits



To purchase a complete gasket kit order both top end and bottom end gasket kit

TOP END GASKET KITS

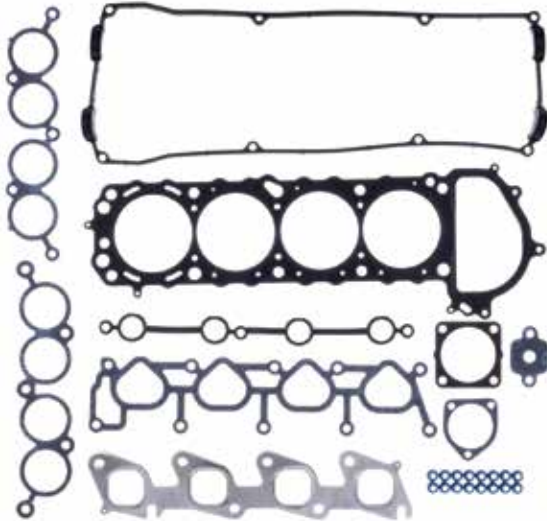

Application	Part #	List Price
KA24DE 1991-94 90mm Bore	PRO2014T	\$147.67
KA24DE 1995-98 90mm Bore.....	PRO2013T	\$147.67

BOTTOM END GASKET KIT



Application	Part #	List Price
KA24DE 1991-98.....	PRO2014B	\$53.35

2.5L QR25DE DOHC 2002-06 FWD: Sentra SE-R/SE-R Spec V, Altima Base/S/SL

Head Gasket

MLS Head Gasket				
Bore	Thickness	Pkg Qty	Part #	List Price
90mm030"	1.....	C4615-030	\$97.27

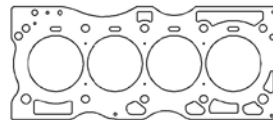

Additional thicknesses available
see page 5

Individual Gaskets

Intake Manifold Gasket Set		
Application	Part #	List Price
QR25DE FWD 02-06.....	C4748	\$32.87

Throttle Body Gasket		
Application	Part #	List Price
QR25DE FWD 02-06.....	C4911	\$7.87



NISSAN

2.5L QR25DE DOHC 2007-12 FWD: Sentra SE-R/SE-R Spec V, Altima Base/S/Hybrid, Rogue S/SL/S Krom/SV

Head Gasket

MLS Head Gasket				
Bore	Thickness	Pkg Qty	Part #	List Price
90mm	.030"	1	C4614-030	\$97.27



Additional thicknesses available
see page 5

Individual Gaskets

Water Inlet Gasket		
Application	Part #	List Price
QR25DE FWD 07-12	C4751	\$4.91

Water Outlet Gasket		
Application	Part #	List Price
QR25DE FWD 07-12	C4917	\$6.12

2.5L QR25DE DOHC 2005-12 RWD: 05-10 Frontier XE, 08-10 Frontier SE, 05 X-Trail LE/SE/XE, 11-12 Frontier S/SV

Head Gasket

MLS Head Gasket				
Bore	Thickness	Pkg Qty	Part #	List Price
90mm	.030"	1	C4616-030	\$97.27

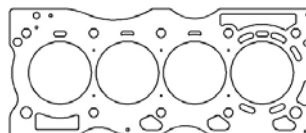

Additional thicknesses available
see page 5

Individual Gaskets

Water Outlet Gasket		
Application	Part #	List Price
QR25DE RWD 05-12	C4918	\$6.12

Water Pump Gasket Set		
Application	Part #	List Price
QR25DE RWD 05-12	C4919	\$21.91

L23, L24S, L24E, L26 Non-Turbo Inline 6 1970-84: 240/260/280Z, Cedric, Fairlady, Datsun 810, Maxima

Head Gasket

MLS Head Gasket				
Bore	Thickness	Pkg Qty	Part #	List Price
85mm	.036"	1	C4579-036	\$182.42
85mm	.040"	1	C4579-040	\$182.42
85mm	.070"	1	C4579-070	\$218.44

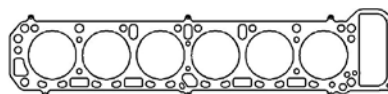

Additional thicknesses available
see page 5

L28E, L28S, L28ES Non-Turbo Inline 6 1975-80: 280Z, 280ZX Patrol, Fairlady, Dedic, Laurel

Head Gasket

MLS Head Gasket				
Bore	Thickness	Pkg Qty	Part #	List Price
89mm	.040"	1	C4580-040	\$182.42

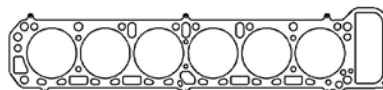

Additional thicknesses available
see page 5



NISSAN

RB25DET 2.5L Inline 6: Patrol 89-93, Skyline 89-93, Skyline GT-R 89-02

Head Gaskets

MLS Head Gaskets

Bore	Thickness	Pkg Qty	Part #	List Price
86mm	051"	1	C4317-051	\$182.40
87mm	051"	1	C4318-051	\$182.40

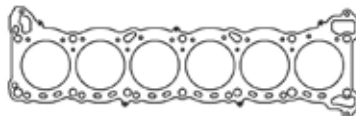

Additional thicknesses available see page 5

Individual Gaskets

Valve Cover Gasket Set

Application	Part #	List Price
RB25DET	C4552	\$35.34

Throttle Body Gasket

Application	Part #	List Price
RB25DET	C4767	\$3.09

Intake Manifold Gasket Set

Application	Part #	List Price
RB25DET	C4768	\$37.50

Rear Main Seal

Application	Part #	List Price
RB25DET	C4770	\$13.40

Exhaust Manifold Gasket

Application	Part #	List Price
RB25DET MLS	C4177-030	\$28.07

Oil Pump Gasket

Application	Part #	List Price
RB25DET	C4769-020	\$7.71

Cam Seal Set

Application	Part #	List Price
RB25DET (pair)	C4739	\$9.21

Front Crank Seal

Application	Part #	List Price
RB25DET	C4914	\$4.61

Valve Stem Seals (sold individually)

Application	Part #	List Price
RB25DET	3175V	\$1.47

Oil Pan Gasket

Application	Part #	List Price
RB20 /RB RB25 88-02	C14117-094	\$61.65

Gasket Kits



To purchase a complete gasket kit order both top end and bottom end gasket kit

TOP END GASKET KIT



Application	Part #	List Price
RB25DET 87mm Bore	PRO2016T	\$278.46

BOTTOM END GASKET KIT

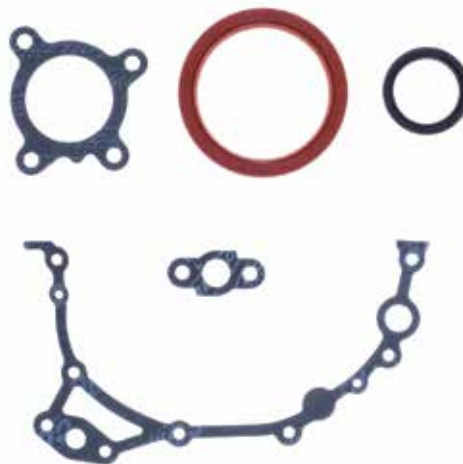

Application	Part #	List Price
RB25DET	PRO2017B	\$53.35



NISSAN

RB26DET 2.6L DOHC Inline 6 Patrol 89-93, Skyline 89-93, Skyline GT-R 89-02

Head Gaskets

MLS Head Gaskets				
Bore	Thickness	Pkg Qty	Part #	List Price
86mm	.051"	1	C4319-051	\$182.40
87mm	.051"	1	C4320-051	\$182.40
88mm	.051"	1	C4321-051	\$182.40

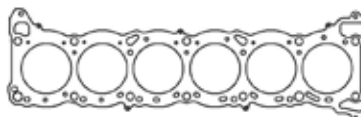

Additional thicknesses available see page 5

Individual Gaskets

Valve Cover Gasket Set		
Application	Part #	List Price
RB26DET	C4552	\$35.34

Throttle Body Gasket Set		
Application	Part #	List Price
RB26DET - 6 Pack	C4920	\$35.35

Intake Manifold Gasket		
Application	Part #	List Price
RB26DET	C4372	\$22.98

Rear Main Seal		
Application	Part #	List Price
RB26DET	C4770	\$13.40

Exhaust Manifold Gasket		
Application	Part #	List Price
RB26DET MLS	C4202-030	\$28.07

Oil Pump Gasket		
Application	Part #	List Price
RB20E/DE/DET 88-93	C4769-020	\$7.71

Cam Seal Set		
Application	Part #	List Price
RB26DET (pair)	C4739	\$9.21

Front Crank Seal		
Application	Part #	List Price
RB20E/DE/DET 88-93	C4914	\$4.61

Valve Stem Seals (sold individually)		
Application	Part #	List Price
RB25DET - EXH	3158V	\$1.38
RB25DET - INT	3175V	\$1.47

Gasket Kits



To purchase a complete gasket kit order both top end and bottom end gasket kit

TOP END GASKET KIT



Application	Part #	List Price
RB26DET 87mm Bore	PRO2017T	\$362.01

BOTTOM END GASKET KIT

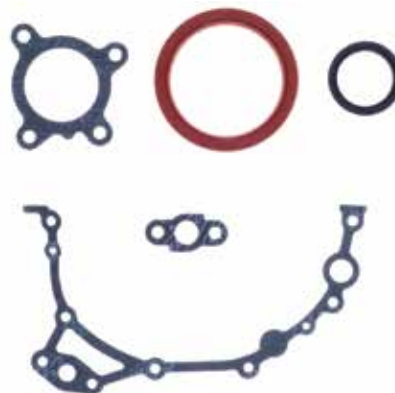

Application	Part #	List Price
RB26DET	PRO2017B	\$53.35



NISSAN

RB30E/RB30ET/RB30S 3.0L DOHC Inline 6: Patrol 87-97, R31 Skyline 86-89, Holden Commodore VL 86-88

Head Gaskets

MLS Head Gaskets

Bore	Thickness	Pkg Qty	Part #	List Price
86mm	.051"	1	C4322-051	\$182.40
87mm	.051"	1	C4323-051	\$182.40

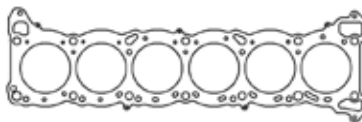

Additional thicknesses available see page 5

Individual Gaskets

Exhaust Manifold Gasket Set

Application	Part #	List Price
RB30E/RB30ET/RB30S	C14126-030	\$30.35

VG30DE/DETT 3.0L 24v DOHC V6 1990-99

Head Gaskets

MLS Head Gaskets

Bore	Thickness	Pkg Qty	Part #	List Price
88mm	.045"	1	C4346-045	\$97.27
90mm	.045"	1	C4347-045	\$97.27



Additional thicknesses available see page 5

Individual Gaskets

Valve Cover Gasket Set

Application	Part #	List Price
VG30DE/DETT	C4773	\$29.44

Oil Pan Gasket

Application	Part #	List Price
VG30DE/DETT	C4776	\$17.82

Intake Manifold Gasket Set

Application	Part #	List Price
VG30DE/DETT	C4772	\$30.74

Rear Main Seal Set

Application	Part #	List Price
VG30DE/DETT	C4775	\$14.51

Exhaust Manifold Gasket Set

Application	Part #	List Price
VG30DE/DETT	C4771-064	\$50.40

Front Crank Seal

Application	Part #	List Price
VG30DE/DETT	C4914	\$4.61

Thermostat Gasket

Application	Part #	List Price
VG30DE/DETT	C4774-031	\$2.53

Water Pump Gasket

Application	Part #	List Price
VG30DE/DETT	C4777-015	\$2.56

Cam Seals (sold in pairs)

Application	Part #	List Price
VG30DE/DETT (need 2 pairs)	C4739	\$9.21

Gasket Kits



To purchase a complete gasket kit order both top end and bottom end gasket kit

TOP END GASKET KIT



Application	Part #	List Price
VG30DE/DETT 88mm Bore	PRO2040T	\$261.30

BOTTOM END GASKET KIT



Application	Part #	List Price
VG30DE/DETT	PRO2040B-2	\$34.49



NISSAN

VQ30DE/VQ35DE V1 3.0/3.5L DOHC V6: 350Z 03-06, G35 03-06, Altima 02-06, I35 02-04, Maxima 02-04, Pathfinder 01-04, Skyline 01-06

Head Gaskets

MLS Head Gaskets - Left Side

Bore	Thickness	Pkg Qty	Part #	List Price
96mm	.030"	1	C4345-030	\$100.45
98mm	.030"	1	C4344-030	\$100.45
100mm	.030"	1	C4343-030	\$100.45
101.5mm	.030"	1	C4381-030	\$100.45

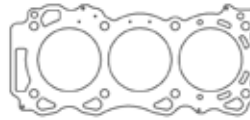

Additional thicknesses available see page 5

MLS Head Gaskets - Right Side

Bore	Thickness	Pkg Qty	Part #	List Price
96mm	.030"	1	C4361-030	\$100.45
98mm	.030"	1	C4362-030	\$100.45
100mm	.030"	1	C4363-030	\$100.45
101.5mm	.030"	1	C4380-030	\$100.45

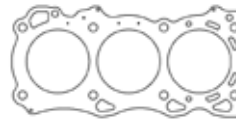

Individual Gaskets

Exhaust Manifold Gasket Set

Application	Part #	List Price
VQ30DE/VQ35DE	C4921-064	\$30.16

VQ35DE V2/VQ35HR/VQ37VHR 3.5/3.7L DOHC V6: G35 07-08, 350Z 07-08, G37 08-Up, 370Z 09-Up

Head Gaskets

MLS Head Gasket - Left Side

Bore	Thickness	Pkg Qty	Part #	List Price
97mm	.030"	1	C4593-030	\$100.45
97mm	.075"	1	C4593-075	\$131.06

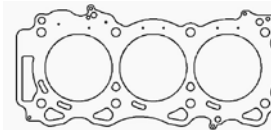

Additional thicknesses available see page 5

MLS Head Gasket - Right Side

Bore	Thickness	Pkg Qty	Part #	List Price
97mm	.030"	1	C4592-030	\$100.45
97mm	.075"	1	C4592-075	\$131.06

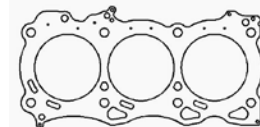

Individual Gaskets

Exhaust Manifold Gasket Set

Application	Part #	List Price
VQ35HR/VQ37VHR	C4921-064	\$30.16

VR38DETT 3.8L DOHC V6: GT-R 08-Up

Head Gaskets

MLX Head Gaskets - Left Side

Bore	Thickness	Pkg Qty	Part #	List Price
96mm	.032"	1	C4570-032	\$100.57
100mm	.032"	1	C4572-032	\$100.57

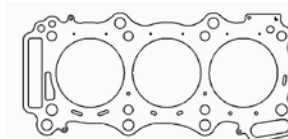

Additional thicknesses available see page 5

MLX Head Gaskets - Right Side

Bore	Thickness	Pkg Qty	Part #	List Price
96mm	.032"	1	C4571-032	\$100.57
100mm	.032"	1	C4573-032	\$100.57

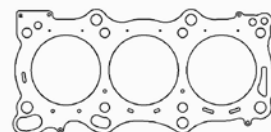



NISSAN

VK45DE 4.5L V8 Infinity Q45 02-06

Head Gaskets

MLS Head Gasket - Left Side

Bore	Thickness	Pkg Qty	Part #	List Price
93.5mm036"1	C4486-036\$96.54

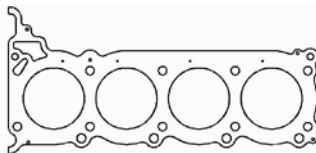

Additional thicknesses available see page 5

MLS Head Gasket - Right Side

Bore	Thickness	Pkg Qty	Part #	List Price
93.5mm036"1	C4485-036\$96.54

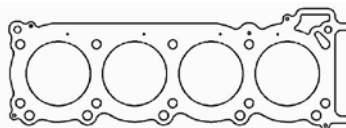

TB48DE 4.8L DOHC Inline 6 2001-Up

Head Gaskets

MLS Head Gasket

Bore	Thickness	Pkg Qty	Part #	List Price
100.5mm030"1	C4511-030\$182.40

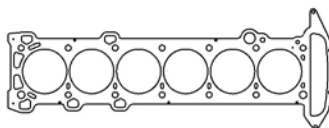

Additional thicknesses available see page 5

MLX Head Gasket

Bore	Thickness	Pkg Qty	Part #	List Price
100.5mm040"1	C4599-040\$243.84

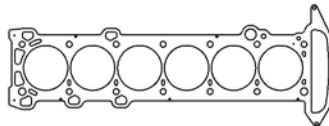

CEV8D1 5.0L DOHC Cummings Nissan Titan XD

Oil Pan Gaskets

Application	Part #	List Price
Lower Engine Oil Pan.....	C14001\$29.01
6 Speed Transmission Oil Pan	C14002\$23.04
7 Speed Oil Pan (Gas Engine).....	C14003\$23.04

Front Differential Gasket

Application	Part #	List Price
4WD - 16 Bolt Differential	C14006-060\$26.73

Crankshaft Seal

Application	Part #	List Price
Rear Main Seal Retainer Gasket.....	C14023\$10.07

VK56DE 5.6L DOHC V8: 2004-15 Armada, 2004-15 Titan, 2004-10 QX56, 2004-12 Pathfinder

Head Gaskets

MLS Head Gasket - Left Side

Bore	Thickness	Pkg Qty	Part #	List Price
100mm040"1	C4922-040\$96.54

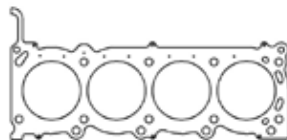

Additional thicknesses available see page 5

MLS Head Gasket - Right Side

Bore	Thickness	Pkg Qty	Part #	List Price
100mm040"1	C4923-040\$96.54





NISSAN

VK56DE 5.6L DOHC V8 2004-Up Armada, 2004-Up Titan, 2004-10 QX56, 2008-12 Pathfinder

Head Gaskets

MLX Head Gasket - Left Side				
Bore	Thickness	Pkg Qty	Part #	List Price
102.7mm040"1	C4610-040\$136.41

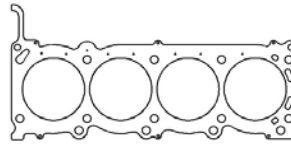

Additional thicknesses available
see page 5

MLX Head Gasket - Right Side				
Bore	Thickness	Pkg Qty	Part #	List Price
102.7mm040"1	C4609-040\$136.41

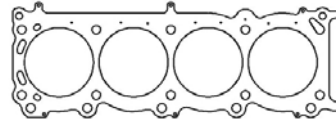

Individual Gaskets

Exhaust Manifold Gasket Set		
Application	Part #	List Price
VK56VD 2010-2016 MLS	C4959-030\$60.74

Exhaust Manifold Gasket Set		
Application	Part #	List Price
VK56DE 2004-09 Oval Port MLS	C4961-030\$60.74
VK56DE 2004-09 Oval Port AM	C4967-064\$32.03

Oil Pan Gasket		
Application	Part #	List Price
Nissan/Suzuki VK56DE, VQ40, VQ40DE 05-17	C14114-060\$13.57

PEUGEOT/CITROEN

TU5J4 1.6L 16v: 106 1997-05

Head Gaskets

MLS Head Gasket				
Bore	Thickness	Pkg Qty	Part #	List Price
79mm060"1	C4493-060\$138.18

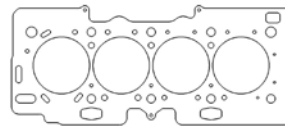

Additional thicknesses available
see page 5

XU9J4, XU9J4Z 1.9L DOHC, XU10J2, XU10J4 2.0L: 405 M1-16, 605 S/SR1

Head Gaskets

MLS Head Gaskets				
Bore	Thickness	Pkg Qty	Part #	List Price
84mm051"1	C4225-051\$109.42
85mm051"1	C4226-051\$109.42
86.5mm051"1	C4227-051\$109.42
88mm051"1	C4228-051\$109.42

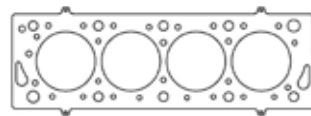

Additional thicknesses available
see page 5

PORSCHE

924 2.0L 1976-85

Head Gasket

MLS Head Gasket				
Bore	Thickness	Pkg Qty	Part #	List Price
88mm050"1	C4542-050\$124.76

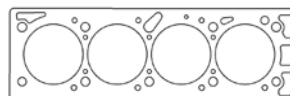

Additional thicknesses available
see page 5



PORSCHE

944 2.5L 1982-91

Head Gaskets

MLS Head Gasket

Bore	Thickness	Pkg Qty	Part #	List Price
100.5mm	.040"	1	C4272-040	\$97.27
103mm	.040"	1	C4273-040	\$97.27

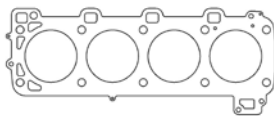

Additional thicknesses available
see page 5

Cam Cover Gasket

Application	Part #	List Price
944 2.5L 82-91	C4925	\$30.33

Intake Manifold Gasket Set

Application	Part #	List Price
944 2.5L 82-91 - 4pcs	C4924	\$9.27

944 2.7L 1989, 3.0L 1989-91

Head Gasket

MLS Head Gasket

Bore	Thickness	Pkg Qty	Part #	List Price
106mm	.040"	1	C4274-040	\$97.27

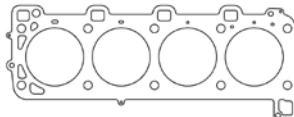

Additional thicknesses available
see page 5

Cam Cover Gasket

Application	Part #	List Price
944 2.7/3.0L	C4925	\$30.33

Intake Manifold Gasket Set

Application	Part #	List Price
944 2.7/3.0L - 4pcs	C4924	\$9.27

996 3.6L 2001-05 Turbo, 2005 Turbo S, 2002-2005 GT2, 2001-2005 GT3

Head Gasket

MLS Head Gasket

Bore	Thickness	Pkg Qty	Part #	List Price
102mm	.040"	1	C4492-040	\$97.27
104mm	.040"	1	C14077-040	\$97.27
104.5mm	.030"	1	C14076-030	\$97.27

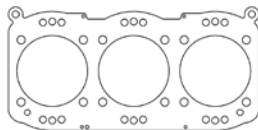

Additional thicknesses available
see page 5

997 3.6L 2007-09 Turbo, 2007-2008 GT3/GT3RS, 2008-2009 GT2, 2011 GT2 RS

Head Gasket

MLS Head Gasket

Bore	Thickness	Pkg Qty	Part #	List Price
106.5mm	.030"	1	C14049-030	\$97.27

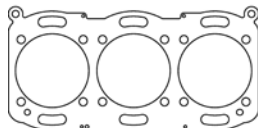

Additional thicknesses available
see page 5

997 3.8L M97.01 2005-08

Head Gasket

MLX Head Gasket

Bore	Thickness	Pkg Qty	Part #	List Price
102mm	.032"	1	C4926-032	\$100.57

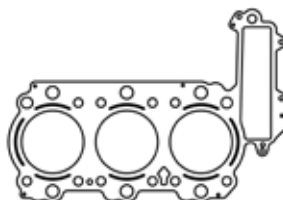

Additional thicknesses available
see page 5



PORSCHE

997.2 3.8L Turbo 2010-2013, 991/991.2 3.8/4.0L Turbo/GT3 2014-2019

Head Gaskets

NEW!

MLX Head Gaskets - CYL 1-3 Left Side				
Bore	Thickness	Pkg Qty	Part #	List Price
105mm	.032"	1	C14142-032	\$100.57
105mm	.040"	1	C14142-040	\$100.57
105mm	.052"	1	C14142-052	\$100.57

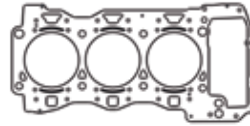

Additional thicknesses available see page 5

NEW!

MLX Head Gaskets - CYL 4-6 Right Side				
Bore	Thickness	Pkg Qty	Part #	List Price
105mm	.032"	1	C14143-032	\$100.57
105mm	.040"	1	C14143-040	\$100.57
105mm	.052"	1	C14143-052	\$100.57

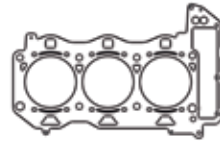

Cayenne GTS 4.5L 2003-06 V8

Head Gaskets

MLS Head Gasket - Left Side				
Bore	Thickness	Pkg Qty	Part #	List Price
95mm	.027"	1	C4535-027	\$97.27

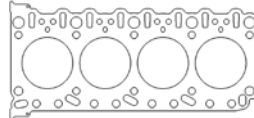

Additional thicknesses available see page 5

MLS Head Gasket - Right Side				
Bore	Thickness	Pkg Qty	Part #	List Price
95mm	.027"	1	C4536-027	\$97.27

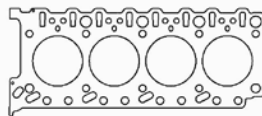

Individual Gaskets

Intake Manifold Gasket Set			
Application	Part #	List Price	
Cayenne 4.5L 03-06 (pair)	C4927	\$28.12	

928 5.0/5.4L 1985-95

Head Gaskets

MLS Head Gaskets - Left Side				
Bore	Thickness	Pkg Qty	Part #	List Price
100mm	.045"	1	C5781-045	\$97.27
104mm	.045"	1	C5783-045	\$97.27

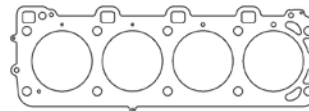

Additional thicknesses available see page 5

MLS Head Gaskets - Right Side				
Bore	Thickness	Pkg Qty	Part #	List Price
100mm	.045"	1	C5780-045	\$97.27
104mm	.045"	1	C5782-045	\$97.27

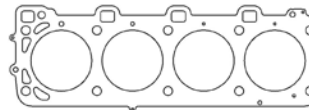



RENAULT

F4P 16v 1.8L, F4R 16v 2.0L: Laguna 98-Up, Clio 01-Up

Head Gaskets

MLS Head Gaskets

Bore	Thickness	Pkg Qty	Part #	List Price
83mm	.030"	1	C4518-030	\$109.42
84.5mm	.030"	1	C4519-030	\$109.42

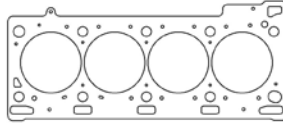

Additional thicknesses available
see page 5

F7P 16v 1.8L, F7R 16v 2.0L: R19 89-96, Clio 91-97, Megane Coupe 95-99, Clio Williams 93-95, Spider Sport 1995

Head Gaskets

MLS Head Gaskets

Bore	Thickness	Pkg Qty	Part #	List Price
83mm	.051"	1	C4539-051	\$109.42
84mm	.051"	1	C4540-051	\$109.42

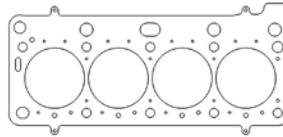

Additional thicknesses available
see page 5

ROVER

15G V8 1970-93, 21D-25D V8 1970-93, 35D-38D 1970-93: Range Rover 1970-89, Discovery 1989-93

Head Gaskets

MLS Head Gasket

Bore	Thickness	Pkg Qty	Part #	List Price
89mm	.040"	1	C4367-040	\$99.69
94mm	.040"	1	C4368-040	\$99.69
96mm	.040"	1	C4369-040	\$99.69

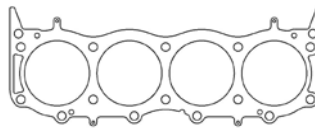

Additional thicknesses available
see page 5

Exhaust Manifold Gasket Set

Application	Part #	List Price
Rover V8 .064" AM	C4966-064	\$28.50

35D-38D, 40D, 42D-46D V8 1994-Up: Discovery 1994-Up

Head Gaskets

MLS Head Gaskets

Bore	Thickness	Pkg Qty	Part #	List Price
89mm	.040"	1	C4366-040	\$99.69
94mm	.040"	1	C4365-040	\$99.69
96mm	.040"	1	C4364-040	\$99.69



Additional thicknesses available
see page 5

Exhaust Manifold Gasket Set

Application	Part #	List Price
Rover V8 .064" AM	C4966-064	\$28.50



ROVER

5.0L V8 "LR-V8": 2009-Up Discovery, Range Rover Sport, Range Rover Sport SC, Range Rover, Range Rover SC

Head Gaskets

MLX Head Gaskets - Left Side				
Bore	Thickness	Pkg Qty	Part #	List Price
93mm	.040"	1	C15001-040	\$107.29

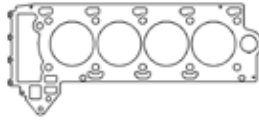

Additional thicknesses available see page 5

MLX Head Gaskets - Right Side				
Bore	Thickness	Pkg Qty	Part #	List Price
93mm	.040"	1	C15000-040	\$107.29

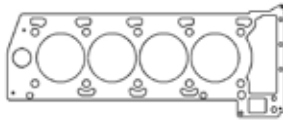

SAAB

B204 1985cc/B234 2290cc Turbo 2.0L: 1995-99 9-3, 9-5, 900

Head Gaskets

MLS Head Gaskets				
Bore	Thickness	Pkg Qty	Part #	List Price
91mm	.030"	1	C4974-030	\$121.56

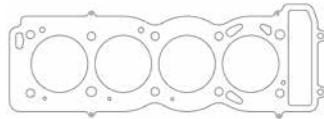

Additional thicknesses available see page 5

B205 1985cc/B235 2290cc Turbo 2.0L: 1999-09 9-3, 9-5

Head Gaskets

MLS Head Gaskets				
Bore	Thickness	Pkg Qty	Part #	List Price
91mm	.030"	1	C4973-030	\$121.56

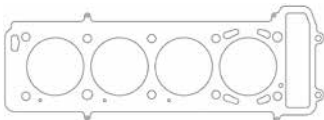

Additional thicknesses available see page 5

SUBARU

FA20F DOHC 2.0L: 2015+Up WRX 2014+Up Forester XT

Head Gaskets

MLX Head Gasket - Left Side				
Bore	Thickness	Pkg Qty	Part #	List Price
89.5mm	.032"	1	C4954-032	\$77.22

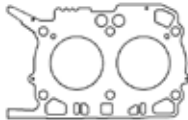

Additional thicknesses available see page 5

MLX Head Gasket - Right Side				
Bore	Thickness	Pkg Qty	Part #	List Price
89.5mm	.032"	1	C4955-032	\$77.22

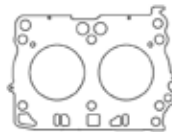



SUBARU

FA20D DOHC 2.0L: 2012+Up BRZ/FRS/86

Head Gaskets

MLX Head Gasket - Left Side

Bore	Thickness	Pkg Qty	Part #	List Price
89.5mm	.032"	1	C4589-032	\$77.22

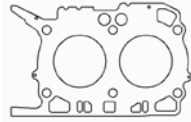

Additional thicknesses available
see page 5

MLX Head Gasket - Right Side

Bore	Thickness	Pkg Qty	Part #	List Price
89.5mm	.032"	1	C4588-032	\$77.22

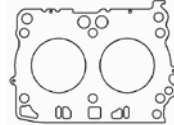

Intake Manifold Gasket Set

Application	Part #	List Price
FA20 - Driver Side and Passenger Side	C14025	\$19.76

Throttle Body Gasket

Application	Part #	List Price
FA20 2012 BRZ+	C14024	\$5.96

Exhaust Gaskets

Application	Part #	List Price
MLS 1.825" Round Port / .030" Thick	C4204-030	\$18.64

EJ20E SOHC 2.0L 16v JDM 1990-97 Legacy, 1995-97 Impreza

Head Gasket

MLS Head Gasket

Bore	Thickness	Pkg Qty	Part #	List Price
93mm	.040"	1	C4260-040	\$52.24

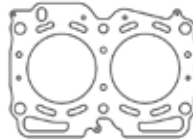

Additional thicknesses available
see page 5

EJ205 DOHC 2.0L 16v 2002-05 WRX, 2004-05 Saab 9-2X Aero

Head Gasket

MLX Head Gasket

Bore	Thickness	Pkg Qty	Part #	List Price
93mm	.041"	1	C4590-041	\$77.22

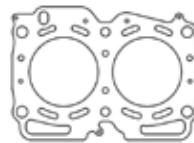

Additional thicknesses available
see page 5

Individual Gaskets

Valve Cover Gasket Sets

Application	Part #	List Price
EJ205 02-05 - Left Side	C4863	\$32.98
EJ205 02-05 - Right Side	C4864	\$32.98

Valve Stem Seals (sold individually)

Application	Part #	List Price
EJ205 02-05 - Exhaust (Brown)	3264V	\$1.74
EJ205 02-05 - Intake (Black)	3265V	\$2.23

Intake Manifold Gaskets

Application	Part #	List Price
EJ205 02-05	C4857-039	\$21.77

Rear Main Seal

Application	Part #	List Price
EJ205 02-05	C4856	\$11.36

Exhaust Gaskets

Application	Part #	List Price
EJ205 02-05 Manifold MLS (2)	C4204-030	\$18.64
EJ205 02-05 Exhaust Pipe (2)	C4856-064	\$9.74
EJ205 02-05 Crossover (2)	C4859-064	\$10.29
EJ205 02-05 Turbo To Up Pipe Gskt (1)	C5723-030	\$9.41
EJ205 02-05 Turbo To Downpipe Gskt (1)	C5736-030	\$9.41

Front Crank Seal

Application	Part #	List Price
EJ205 02-05	C4857	\$21.77



SUBARU

EJ205 DOHC 2.0L 16v 2002-05 WRX, 2004-05 Saab 9-2X Aero

Individual Gaskets

Throttle Body Gasket		
Application	Part #	List Price
EJ205 02-05	C4855-060	\$5.96

Water Pump Gasket		
Application	Part #	List Price
EJ205 02-05	C4860-018	\$6.12

Individual Gaskets

Cam Seal Set		
Application	Part #	List Price
EJ205 02-05 - 4 Pack	C4858	\$25.27

Thermostat Gasket		
Application	Part #	List Price
EJ205 02-05	C4861	\$4.69

Gasket Kits

GASKET KIT

Application	Part #	List Price
EJ205 02-03 93.5mm Bore.....	PRO2044C	\$359.02

GASKET KIT

Application	Part #	List Price
EJ205 04-05	PRO2023C	\$272.67

EJ22E SOHC 2.2L 16v 1990-96 Legacy, 1993-96 Impreza

Head Gasket

MLS Head Gasket				
Bore	Thickness	Pkg Qty	Part #	List Price
98mm040"	1	C4262-040	\$52.24
100mm040"	1	C4985-040	\$52.24

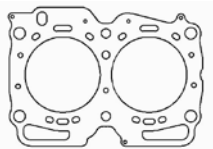

Additional thicknesses available see page 5

MLX Head Gasket				
Bore	Thickness	Pkg Qty	Part #	List Price
101mm041"	1	C4986-041	\$77.22

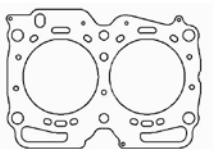

Individual Gaskets

Valve Cover Gasket Set		
Application	Part #	List Price
EJ22E SOHC	C4871	\$32.98

Thermostat Gasket		
Application	Part #	List Price
EJ22E SOHC	C4861	\$4.69



SUBARU

EJ22E SOHC 2.2L 16v 1990-96 Legacy, 1993-96 Impreza

Individual Gaskets

Intake Manifold Gasket Set

Application	Part #	List Price
EJ22E SOHC	C4868-060	\$19.36

Exhaust Gaskets

Application	Part #	List Price
EJ22E SOHC MLS	C4204-030	\$18.64

Throttle Body Gasket

Application	Part #	List Price
EJ22E SOHC	C4867-060	\$5.96

Cam Seal Set

Application	Part #	List Price
EJ22E SOHC - 2 pack	C4870	\$16.93

Valve Stem Seals (sold individually)

Application	Part #	List Price
EJ22E SOHC - Exhaust (Brown)	3264V	\$1.74
EJ22E SOHC - Intake (Black)	3265V	\$2.23

Oil Pan Gasket

Application	Part #	List Price
EJ22E SOHC - Cork	C4869-125	\$11.70

Rear Main Seal

Application	Part #	List Price
EJ22E SOHC	C4856	\$11.36

Front Crank Seal

Application	Part #	List Price
EJ22E SOHC	C4857	\$6.58

Water Pump Gasket

Application	Part #	List Price
EJ22E SOHC	C4860-018	\$6.12

Timing Cover Set

Application	Part #	List Price
EJ22E SOHC	C4862	\$48.40

Gasket Kit



GASKET KIT



Application	Part #	List Price
EJ22E SOHC 98mm Bore	PRO2026C	\$266.99

EJ22T SOHC 2.2L 16v Turbo: 1991-94 Legacy

Head Gasket

MLS Head Gasket

Bore	Thickness	Pkg Qty	Part #	List Price
98mm	051"	1	C4263-051	\$52.24

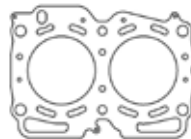

Additional thicknesses available
see page 5

Individual Gaskets

Valve Cover Gasket Set

Application	Part #	List Price
EJ22T SOHC Turbo	C4871	\$32.98

Oil Pan Gasket

Application	Part #	List Price
EJ22T SOHC Turbo	C4869-125	\$11.70

See page 137 for additional gaskets



SUBARU

EJ22T SOHC 2.2L 16v Turbo: 1991-94 Legacy

Individual Gaskets

Intake Manifold Gasket Set		
Application	Part #	List Price
EJ22T SOHC Turbo.....	C4868-060	\$19.36

Rear Main Seal		
Application	Part #	List Price
EJ22T SOHC Turbo.....	C4856	\$11.36

Cam Seal Set		
Application	Part #	List Price
EJ22T SOHC Turbo - 2pcs.....	C4870	\$16.93

Front Crank Seal		
Application	Part #	List Price
EJ22T SOHC Turbo.....	C4857	\$6.58

Valve Stem Seals (sold individually)		
Application	Part #	List Price
EJ22T SOHC - Exhaust (Brown).....	3264V	\$1.74
EJ22T SOHC - Intake (Black).....	3265V	\$2.23

Water Pump Gasket		
Application	Part #	List Price
EJ22T SOHC Turbo.....	C4860-018	\$6.12

EJ25D DOHC 2.5L 16v 1998 Impreza RS, 1996-99 Legacy/Outback, 1998 Forester

Head Gasket

MLX Head Gasket				
Bore	Thickness	Pkg Qty	Part #	List Price
101mm.....	.052".....	1.....	C4578-052	\$77.22

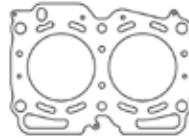

Additional thicknesses available see page 5

Individual Gaskets

Valve Cover Gasket Set		
Application	Part #	List Price
EJ25D DOHC.....	C4873	\$47.12

Thermostat Gasket		
Application	Part #	List Price
EJ25D DOHC.....	C4861	\$4.69

Intake Manifold Gasket Set		
Application	Part #	List Price
EJ25D DOHC.....	C4872-059	\$28.00

Oil Pan Gasket		
Application	Part #	List Price
EJ25D DOHC - Cork.....	C4869-125	\$11.70

Exhaust Gaskets		
Application	Part #	List Price
EJ25D DOHC MLS.....	C4204-030	\$18.64

Timing Cover Set		
Application	Part #	List Price
EJ25D DOHC.....	C4862	\$48.40

Throttle Body Gasket		
Application	Part #	List Price
EJ25D DOHC.....	C4867-060	\$5.96

Rear Main Seal		
Application	Part #	List Price
EJ25D DOHC.....	C4856	\$11.36

Cam Seal Set		
Application	Part #	List Price
EJ25D DOHC - 4pcs.....	C4866	\$33.86

Front Crank Seal		
Application	Part #	List Price
EJ25D DOHC.....	C4857	\$6.58

Valve Stem Seals (sold individually)		
Application	Part #	List Price
EJ25D DOHC - Exhaust (Brown).....	3264V	\$1.74
EJ25D DOHC - Intake (Black).....	3265V	\$2.23

Water Pump Gasket		
Application	Part #	List Price
EJ25D DOHC.....	C4860-018	\$6.12

See page 138 for StreetPro gasket kits



SUBARU

EJ25D DOHC 2.5L 16v 1998 Impreza RS, 1996-99 Legacy/Outback, 1998 Forester

Gasket Kit



GASKET KIT



Application	Part #	List Price
EJ25D DOHC 1996-99 101mm Bore	PRO2025C	\$339.71

EJ251/EJ253 SOHC 2.5L 16v (EJ251): 09/00-03/03 Impreza, 00-02,04 Outback Sport, 11/01-03/04 Forester, 06/99-06/06 Legacy/Outback, 06/02-04/06 Baja (EJ253): 01/04-Up Forester, 04/03+Up Impreza, 11/03-04/09 Legacy/Outback

Head Gasket

MLX Head Gasket				
Bore	Thickness	Pkg Qty	Part #	List Price
101mm032"	1	C4578-032	\$77.22

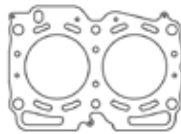

Additional thicknesses available see page 5

Individual Gaskets

Valve Cover Gasket Set		
Application	Part #	List Price
EJ251 SOHC	C4642	\$35.34

Throttle Body Gasket		
Application	Part #	List Price
EJ251 SOHC	C4874-060	\$5.96

Intake Manifold Gasket Set		
Application	Part #	List Price
EJ251 SOHC	C4875-060	\$21.77

Thermostat Gasket		
Application	Part #	List Price
EJ251 SOHC	C4861	\$4.69

Exhaust Gaskets		
Application	Part #	List Price
EJ251 SOHC MLS	C4204-030	\$18.64

Rear Main Seal		
Application	Part #	List Price
EJ251 SOHC	C4856	\$11.36

Cam Seal Set		
Application	Part #	List Price
EJ251 SOHC 2pcs	C4870	\$16.93

Front Crank Seal		
Application	Part #	List Price
EJ251 SOHC	C4857	\$6.58

Valve Stem Seals (sold individually)		
Application	Part #	List Price
EJ251 SOHC - Exhaust (Brown)	3264V	\$1.74
EJ251 SOHC - Intake (Black)	3265V	\$2.23

Water Pump Gasket		
Application	Part #	List Price
EJ251 SOHC	C4860-018	\$6.12

See page 139 for StreetPro gasket kits



SUBARU

EJ251/EJ253 SOHC 2.5L 16v (EJ251): 09/00-03/03 Impreza, 00-02,04 Outback Sport, 11/01-03/04 Forester, 06/99-06/06 Legacy/Outback, 06/02-04/06 Baja (EJ253): 01/04-Up Forester, 04/03+Up Impreza, 11/03-04/09 Legacy/Outback

Gasket Kit



GASKET KIT



Application	Part #	List Price
EJ251 SOHC 1999-05 101mm Bore	PRO2022C	\$221.52

EJ253 SOHC 2.5L 16v 02/09-12/14 Legacy/Outback non-turbo

Head Gaskets

MLX Head Gasket - "Improved Cooling Heads"				
Bore	Thickness	Pkg Qty	Part #	List Price
101mm032"1	C4622-032	\$77.22

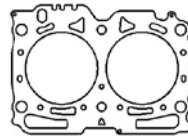

Additional thicknesses available see page 5

Individual Gaskets

Intake Manifold Gasket Set		
Application	Part #	List Price
EJ253 SOHC	C4875-060	\$21.77

Thermostat Gasket		
Application	Part #	List Price
EJ253 SOHC	C4861	\$4.69

Exhaust Gaskets		
Application	Part #	List Price
EJ253 SOHC MLS	C4204-030	\$18.64

Rear Main Seal		
Application	Part #	List Price
EJ253 SOHC	C4856	\$11.36

Cam Seal Set		
Application	Part #	List Price
EJ253 SOHC 2pcs	C4870	\$16.93

Front Crank Seal		
Application	Part #	List Price
EJ253 SOHC	C4947	\$6.58

Valve Stem Seals (sold individually)		
Application	Part #	List Price
EJ253 SOHC - Exhaust (Brown)	3264V	\$1.74
EJ253 SOHC - Intake (Black)	3265V	\$2.23

Water Pump Gasket		
Application	Part #	List Price
EJ253 SOHC	C4860-018	\$6.12

Oil Pan Gasket		
Application	Part #	List Price
EJ255/ EJ257 - Cork	C4869-125	\$11.70



SUBARU

EJ255 DOHC 2.5L 16v Turbo 02/03-04/06 Baja Turbo3-03/05 Forester XT, 02/03-06/06 Legacy/Outback Turbo

Head Gasket

MLX Head Gasket

Bore	Thickness	Pkg Qty	Part #	List Price
101mm032"1	C4578-032	\$77.22



Additional thicknesses available
see page 5

EJ255 DOHC 2.5L 16v Turbo 01/05-03/08 Forester XT, 04/05-03/08 Impreza WRX, 11/05-04/09 Legacy/Outback Turbo

Head Gasket

MLX Head Gasket - "Improved Cooling Heads"

Bore	Thickness	Pkg Qty	Part #	List Price
101mm032"1	C4622-032	\$77.22

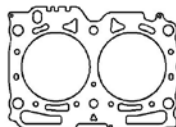

Additional thicknesses available
see page 5

Individual Gaskets

Valve Cover Gasket Sets

Application	Part #	List Price
EJ255 06-07 - Left Side	C4880	\$23.56
EJ255 06-07 - Right Side	C4881	\$23.56

Throttle Body Gasket

Application	Part #	List Price
EJ255 DOHC 06-07	C4877-060	\$5.96

Intake Manifold Gasket Set

Application	Part #	List Price
EJ255 DOHC 06-07	C4857-039	\$21.77

Thermostat Gasket

Application	Part #	List Price
EJ255 DOHC 06-07	C4861	\$4.69

Exhaust Gaskets

Application	Part #	List Price
EJ255 06-07 Manifold MLS (2)	C4204-030	\$18.64
EJ255 06-07 Crossover (2)	C4859-064	\$10.29
EJ255 Turbo To Up Pipe Gasket (1)	C5723-030	\$9.41
EJ255 Turbo To Downpipe Gasket (1)	C5736-030	\$9.41

Rear Main Seal

Application	Part #	List Price
EJ255 DOHC 06-07	C4856	\$11.36

Cam Seal Sets

Application	Part #	List Price
EJ255 06-07 Exhaust Seals (2)	C4878	\$12.64
EJ255 06-07 Intake Seals (2)	C4879	\$20.21

Front Crank Seal

Application	Part #	List Price
EJ255 DOHC 06-07	C4947	\$6.58

Valve Stem Seals (sold individually)

Application	Part #	List Price
EJ255 DOHC - Exhaust (Brown)	3264V	\$1.74
EJ255 DOHC - Intake (Black)	3265V	\$2.23

Water Pump Gasket

Application	Part #	List Price
EJ255 DOHC 06-07	C4860-018	\$6.12

Timing Cover Set

Application	Part #	List Price
EJ255 DOHC 06-07	C4862	\$48.40

See page 141 for StreetPro gasket kits



SUBARU

EJ255 DOHC 2.5L 16v Turbo 01/05-03/08 Forester XT, 04/05-03/08 Impreza WRX, 11/05-04/09 Legacy/Outback Turbo

Gasket Kit



GASKET KIT



Application	Part #	List Price
EJ255 DOHC 2006-07 101mm Bore	PRO2045C	\$359.02

EJ255 DOHC 2.5L 16v Turbo 04/08-Up Forester XT, 04/08-Up Impreza WRX, 02/09-Up Legacy/Outback Turbo

Head Gasket

MLX Head Gasket				
Bore	Thickness	Pkg Qty	Part #	List Price
101mm032"	1	C4587-032	\$77.22

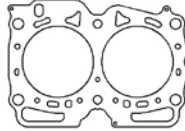

Additional thicknesses available
see page 5

Individual Gaskets

Valve Cover Gasket Sets			
Application	Part #	List Price	
EJ255 08-Up - Left Side	C4880	\$23.56	
EJ255 08-Up - Right Side	C4881	\$23.56	

Throttle Body Gasket		
Application	Part #	List Price
EJ255 DOHC 08-Up	C4882	\$4.75

Intake Manifold Gasket Set		
Application	Part #	List Price
EJ255 DOHC 08-Up	C4857-039	\$21.77

Thermostat Gasket		
Application	Part #	List Price
EJ255 DOHC 08-Up	C4861	\$4.69

Exhaust Gaskets		
Application	Part #	List Price
EJ255 08-Up Manifold MLS (2)	C4204-030	\$18.64
EJ255 Turbo To Up Pipe Gasket (1)	C5723-030	\$9.41
EJ255 Turbo To Downpipe Gasket (1)	C5736-030	\$9.41

Rear Main Seal		
Application	Part #	List Price
EJ255 DOHC 08-Up	C4856	\$11.36

Cam Seal Sets		
Application	Part #	List Price
EJ255 08-Up Exh Seals (2)	C4878	\$12.64
EJ255 08-Up Intake Seals (2)	C4879	\$20.21

Front Crank Seal		
Application	Part #	List Price
EJ255 DOHC 08-Up	C4857	\$6.58

See page 142 for additional gaskets



SUBARU

EJ255 DOHC 2.5L 16v Turbo 04/08-Up Forester XT, 04/08-Up Impreza WRX, 02/09-Up Legacy/Outback Turbo

Individual Gaskets

Valve Stem Seals (sold individually)

Application	Part #	List Price
EJ255 DOHC - Exhaust (Brown)	3264V	\$1.74
EJ255 DOHC - Intake (Black).....	3265V	\$2.23

Water Pump Gasket

Application	Part #	List Price
EJ255 DOHC 08-Up.....	C4860-018	\$6.12

Gasket Kit



GASKET KIT



Application	Part #	List Price
EJ255 DOHC 2008-Up 101mm Bore	PRO2046C	\$329.48

EJ257 DOHC 2.5L 16v Turbo: 10/02-06/07 Impreza STi

Head Gasket

MLX Head Gasket

Bore	Thickness	Pkg Qty	Part #	List Price
101mm032"	1.....	C4578-032	\$77.22

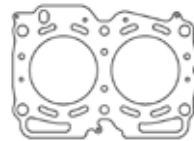

Additional thicknesses available
see page 5

Individual Gaskets

Valve Cover Gasket Sets

Application	Part #	List Price
EJ257 04-07 - Left Side.....	C4928	\$23.56
EJ257 04-07 - Right Side	C4929	\$23.56

Throttle Body Gasket

Application	Part #	List Price
EJ257 DOHC 04-07.....	C4877-060	\$5.96

Intake Manifold Gasket Set

Application	Part #	List Price
EJ257 DOHC 04-07.....	C4857-039	\$21.77

Thermostat Gasket

Application	Part #	List Price
EJ257 DOHC 04-07.....	C4861	\$4.69

See page 143 for additional gaskets



SUBARU

EJ257 DOHC 2.5L 16v Turbo 10/02-06/07 Impreza STi

Individual Gaskets

Exhaust Gaskets		
Application	Part #	List Price
EJ257 04-07 Manifold MLS (2).....	C4204-030	\$18.64
EJ257 04-07 Crossover (1).....	C5718	\$5.14
EJ255 Turbo To Up Pipe Gasket (1).....	C5723-030	\$9.41
EJ255 Turbo To Downpipe Gasket (1).....	C5736-030	\$9.41

Timing Cover Set		
Application	Part #	List Price
EJ257 DOHC 2007.....	C4862	\$48.40

Cam Seal Sets		
Application	Part #	List Price
EJ257 04-07 Exh Seals (2).....	C4878	\$12.64
EJ257 04-07 Intake Seals (2).....	C4879	\$20.21

Rear Main Seal		
Application	Part #	List Price
EJ257 DOHC 04-07.....	C4856	\$11.36

Valve Stem Seals (sold individually)		
Application	Part #	List Price
EJ257 DOHC - Exhaust (Brown).....	3264V	\$1.74
EJ257 DOHC - Intake (Black).....	3265V	\$2.23

Front Crank Seal		
Application	Part #	List Price
EJ257 DOHC 04-07.....	C4947	\$6.58

Water Pump Gasket		
Application	Part #	List Price
EJ257 DOHC 04-07.....	C4860-018	\$6.12

Gasket Kits



GASKET KIT

Application	Part #	List Price
EJ257 DOHC 04-06 101mm Bore.....	PRO2024C	\$282.89

GASKET KIT

Application	Part #	List Price
EJ257 DOHC 2007 101mm Bore.....	PRO2047C	\$336.40



SUBARU

EJ257 DOHC 2.5L 16v Turbo: 04/07-2017 Impreza STi

Head Gasket

MLX Head Gasket

Bore	Thickness	Pkg Qty	Part #	List Price
101mm	.032"	1	C4587-032	\$77.22

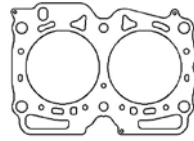

Additional thicknesses available
see page 5

Individual Gaskets

Valve Cover Gasket Sets

Application	Part #	List Price
EJ257 08-Up - Left Side	C4880	\$23.56
EJ257 08-Up - Right Side	C4881	\$23.56

Throttle Body Gasket

Application	Part #	List Price
EJ257 DOHC 08-Up	C4877-060	\$5.96

Intake Manifold Gasket Set

Application	Part #	List Price
EJ257 DOHC 08-Up	C4857-039	\$21.77

Thermostat Gasket

Application	Part #	List Price
EJ257 DOHC 08-Up	C4861	\$4.69

Exhaust Gaskets

Application	Part #	List Price
EJ257 08-Up Manifold MLS (2)	C4204-030	\$18.64
EJ257 08-Up Crossover (1)	C5718	\$5.14
EJ255 Turbo To Up Pipe Gasket (1)	C5723-030	\$9.41
EJ255 Turbo To Downpipe Gasket (1)	C5736-030	\$9.41

Timing Cover Set

Application	Part #	List Price
EJ257 DOHC 08-Up	C4862	\$48.40

Cam Seal Set

Application	Part #	List Price
EJ257 08+Up 4pcs	C4876	\$40.40

Rear Main Seal

Application	Part #	List Price
EJ257 DOHC 08-Up	C4856	\$11.36

Valve Stem Seals (sold individually)

Application	Part #	List Price
EJ257 DOHC - Exhaust (Brown)	3264V	\$1.74
EJ257 DOHC - Intake (Black)	3265V	\$2.23

Front Crank Seal

Application	Part #	List Price
EJ257 DOHC 08-Up	C4947	\$6.58

Oil Pan Gasket

Application	Part #	List Price
EJ255/ EJ257 - Cork	C4869-125	\$11.70

Water Pump Gasket

Application	Part #	List Price
EJ257 DOHC 08-Up	C4860-018	\$6.12

Gasket Kit



GASKET KIT



Application	Part #	List Price
EJ257 DOHC 08-Up 101mm Bore	PRO2048C	\$347.57



SUBARU

EZ30D mk I 3.0L Flat 6: 2000-02 Legacy/Outback

Head Gaskets

MLS Head Gasket - Left Side				
Bore	Thickness	Pkg Qty	Part #	List Price
90mm	.040"	1	C5861-040	\$88.74

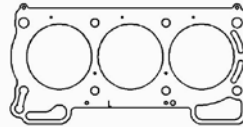

Additional thicknesses available see page 5

MLS Head Gasket - Right Side				
Bore	Thickness	Pkg Qty	Part #	List Price
90mm	.040"	1	C5860-040	\$88.47

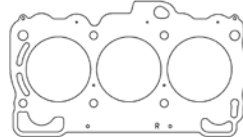

EZ30D mk II 3.0L Flat 6: 2003-09 Legacy/Outback, 2006-07 Tribeca

Head Gaskets

MLS Head Gasket - Left Side				
Bore	Thickness	Pkg Qty	Part #	List Price
90mm	.040"	1	C4623-040	\$88.74

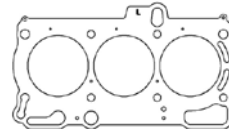

Additional thicknesses available see page 5

MLS Head Gasket - Right Side				
Bore	Thickness	Pkg Qty	Part #	List Price
90mm	.040"	1	C4624-040	\$88.74

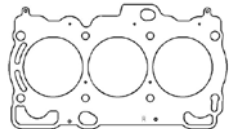

EZ36D 3.6L Flat 6 2010-12 Legacy 3.6R / Outback, 2008-14 Tribeca

Individual Gaskets

Oil Pan Gasket			
Application	Part #	List Price	
EJ255/ EJ257/ EZ36D - Cork	C4869-125	\$11.70	

EG33 3.3L Flat 6 3318cc 1992-96 SVX

Head Gaskets

MLS Head Gaskets				
Bore	Thickness	Pkg Qty	Part #	List Price
98mm	.066"	1	C4340-066	\$124.76
100mm	.066"	1	C4341-066	\$124.76
102mm	.066"	1	C4342-066	\$124.76

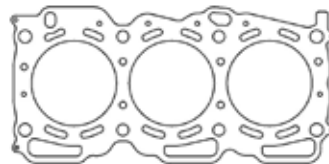

Additional thicknesses available see page 5



TOYOTA

1.3L 4E-FE/4E-FTE/ 1.5L 5E-FE/5E-FHE: 1986-98 Corolla, Corona, Starlet, Tercel, Paseo, Sera

Head Gaskets

MLS Head Gaskets

Bore	Thickness	Pkg Qty	Part #	List Price
75mm	.040"	1	C4602-040	\$102.11
76mm	.040"	1	C4603-040	\$102.11

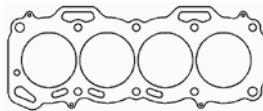

Additional thicknesses available see page 5

2T 1.6l, 2TC 1.6L, 3T 1.8L, 3TC 1.8L 1970-84 Corolla, 1970-76 Sprinter, 1970-76 Celica, 1970-76 Carina, 1970-84 Corona, 1978-84 Camry

Head Gaskets

MLS Head Gaskets

Bore	Thickness	Pkg Qty	Part #	List Price
87mm	.040"	1	C4258-040	\$97.27
89mm	.040"	1	C4176-040	\$97.27

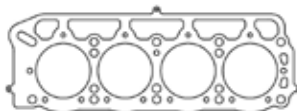

Additional thicknesses available see page 5

Exhaust Manifold Gasket

Application	Part #	List Price
3TC 1.8L	C4930	\$19.18

4A-GE, 4A-GEC, 4A-GELC, 4A-GEZ 16v 1587cc: 1984-92 Corolla, 1989 Carina, 1989 Sprinter, 1984-89 MR2, 1989-89 Celica

Head Gaskets

MLS Head Gaskets

Bore	Thickness	Pkg Qty	Part #	List Price
81mm	.040"	1	C4170-040	\$97.27
83mm	.040"	1	C4166-040	\$97.27



Additional thicknesses available see page 5

Individual Gaskets

Valve Cover Gasket Set

Application	Part #	List Price
4A-GE 84-92 16v	C4807	\$18.84

Thermostat Gasket

Application	Part #	List Price
4A-GE 84-92 16v	C4809	\$8.63

Intake Gasket Set

Application	Part #	List Price
4A-GE 84-92 16v	C4806	\$21.77

Timing Cover Dust Seal Set

Application	Part #	List Price
4A-GE 84-92 16v	C4811	\$15.35

Exhaust Manifold Gasket

Application	Part #	List Price
4A-GE 84-92 16v .042" AM	C4805-042	\$19.18

Rear Main Seal

Application	Part #	List Price
4A-GE 84-92 16v	C4810	\$11.19

Cam Seal Set

Application	Part #	List Price
4A-GE 84-92 16v 2pcs	C4808	\$11.60

Front Crank Seal

Application	Part #	List Price
4A-GE 84-92 16v	C4931	\$3.48

Valve Stem Seals (sold individually)

Application	Part #	List Price
4A-GE 84-92 16v	3225V	\$1.75

Water Pump Gasket

Application	Part #	List Price
4A-GE 84-92 16v	C4812-039	\$2.20

See page 146 for StreetPro gasket kits



TOYOTA

4A-GE, 4A-GEC, 4A-GELC 16v 1587cc 1984-92 Corolla, 1989 Carina, 1989 Sprinter, 1984-89 MR2, 1989-89 Celica

Gasket Kits



TOP END GASKET KIT

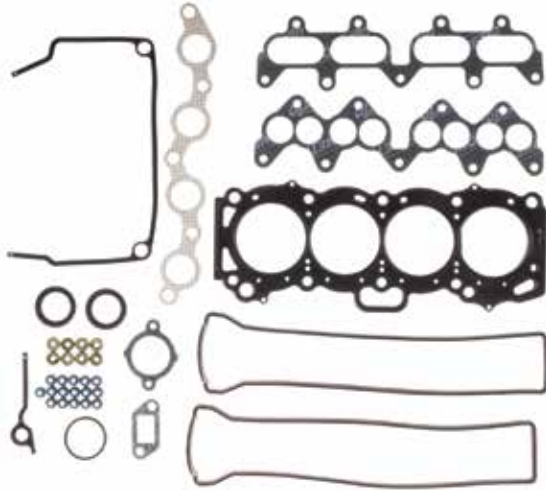

Application	Part #	List Price
4A-GE 84-92 16v 81mm Bore	PRO2041T	\$215.85

TOP END GASKET KIT



Application	Part #	List Price
4A-GE 84-92 16v	PRO2041B	\$22.66

4A-GE 1.6L 20v 1587cc 1991-95 Corolla, 1996-01 Carina, 1991-00 Sprinter

Head Gaskets

MLS Head Gaskets

Bore	Thickness	Pkg Qty	Part #	List Price
81mm040"	1	C4604-040	\$97.27
83mm040"	1	C4605-040	\$97.27

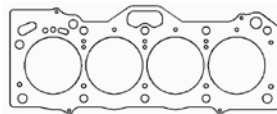

Additional thicknesses available see page 5

Individual Gaskets

Intake Manifold Gasket

Application	Part #	List Price
4A-GE 20v Small Port	C4932-031	\$10.88

Exhaust Manifold Gasket

Application	Part #	List Price
4A-GE 20v .064" AM.....	C4933-064	\$19.18

1ZZ-FE 1.8L DOHC 1997-08

Head Gaskets

MLS Head Gaskets

Bore	Thickness	Pkg Qty	Part #	List Price
80mm027"	1	C4496-027	\$97.27
82mm027"	1	C4497-027	\$97.27

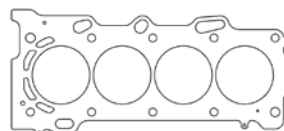

Additional thicknesses available see page 5

Individual Gaskets

Intake Manifold Gasket

Application	Part #	List Price
1ZZ-FE .032" AFM	C4934-032	\$6.57

Exhaust Manifold Gasket

Application	Part #	List Price
1ZZ-FE 98-02 .030" MLS.....	C4205-030	\$24.69



TOYOTA

2ZZ-GE 1.8L DOHC 1795cc 00-05 Celica, 05-06 Corolla, 03-06 Matrix/Vibe, 05-11 Lotus Elise, 06-10 Lotus Exige

Head Gasket

MLX Head Gasket

Bore	Thickness	Pkg Qty	Part #	List Price
82.5mm	.028"	1	C4962-028	\$120.47
82.5mm	.040"	1	C4962-040	\$153.90

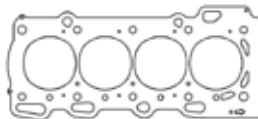

Additional thicknesses available see page 5

3S-GE/3S-GTE 2.0L DOHC Turbo 1998cc 1989-94 Celica, 1990-94 MR2

Head Gasket

MLS Head Gasket

Bore	Thickness	Pkg Qty	Part #	List Price
87mm	.040"	1	C4314-040	\$97.27

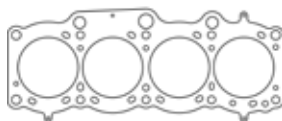

Additional thicknesses available see page 5

Individual Gaskets

Valve Cover Gasket Set

Application	Part #	List Price
3S-GTE 90-95	C4608	\$38.88

Oil Pan Gasket

Application	Part #	List Price
3S-GE/GTE 91-95	C4817-062	\$7.87

Intake Manifold Gasket Set

Application	Part #	List Price
3S-GE/GTE 88-95	C4813	\$21.77

Timing Cover Dust Seal Set

Application	Part #	List Price
3S-GE/GTE 89-94	C4811	\$15.35

Exhaust Manifold Gasket

Application	Part #	List Price
3S-GE/GTE 89-95 MLS	C4206-030	\$30.65

Water Pump Gasket

Application	Part #	List Price
3S-GE/GTE 89-94	C4818-031	\$2.56

Cam Seal Set

Application	Part #	List Price
3S-GE/GTE 89-95	C4808	\$11.60

Rear Main Seal Set

Application	Part #	List Price
3S-GE/GTE 89-94	C4815	\$20.49

Valve Stem Seals (sold individually)

Application	Part #	List Price
3S-GE/GTE 89-95	3225V	\$1.75

Oil Pump Gasket Set

Application	Part #	List Price
3S-GE/GTE 89-94	C4816	\$9.84

Gasket Kits



TOP END GASKET KIT

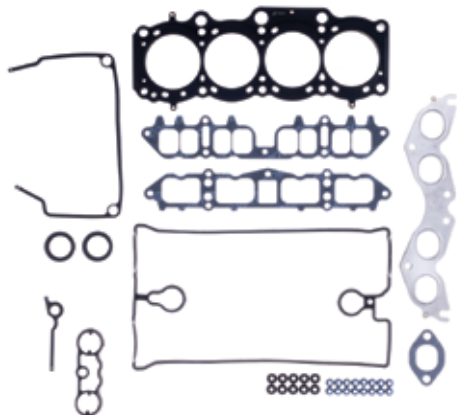

Application	Part #	List Price
3S-GTE 89-94	PRO2019T	\$170.39

BOTTOM END GASKET KIT

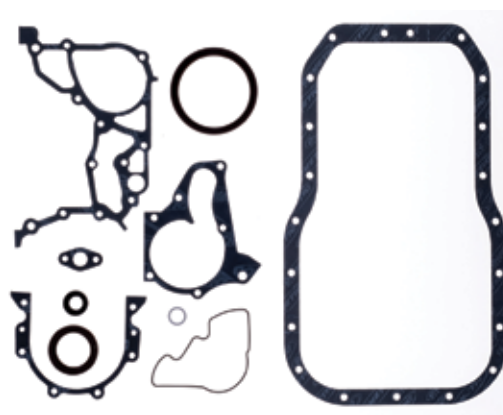

Application	Part #	List Price
3S-GE/GTE 89-94	PRO2019B	\$71.53



TOYOTA

3S-GE/3S-GTE 2.0L DOHC Turbo 3rd Gen, ST205 1994-99

Head Gasket

MLS Head Gasket				
Bore	Thickness	Pkg Qty	Part #	List Price
87mm040"1	C4606-040	\$97.27

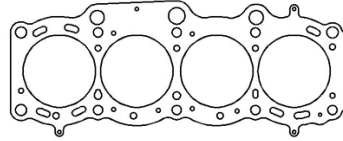

Additional thicknesses available
see page 5

5S-FE 2.2L 2164cc 1990-97 Camry, 1990-97 Celica, 1990-97 MR2

Head Gasket

MLS Head Gasket				
Bore	Thickness	Pkg Qty	Part #	List Price
88mm040"1	C4315-040	\$97.27

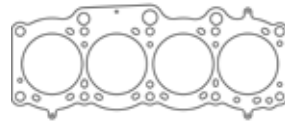

Additional thicknesses available
see page 5

Individual Gaskets

Valve Cover Gasket Set		
Application	Part #	List Price
5S-FE 1990-97	C4820	\$27.09

Oil Pan Gasket		
Application	Part #	List Price
5S-FE 1990-97	C4817-062	\$7.87

Intake Manifold Gasket Set		
Application	Part #	List Price
5S-FE 1990-97	C4819-046	\$3.32

Water Pump Gasket		
Application	Part #	List Price
5S-FE 1990-97	C4818-031	\$2.56

Exhaust Manifold Gasket		
Application	Part #	List Price
5S-FE 1990-97 MLS	C4206-030	\$30.65

Rear Main Seal Set		
Application	Part #	List Price
5S-FE 1990-97	C4823	\$13.56

Cam Seal Set		
Application	Part #	List Price
5S-FE 1990-97	C4821	\$3.93

Oil Pump Gasket Set		
Application	Part #	List Price
5S-FE 1990-97	C4824	\$5.72

Valve Stem Seals (sold individually)		
Application	Part #	List Price
5S-FE 1990-97	3225V	\$1.75

Thermostat Gasket Set		
Application	Part #	List Price
5S-FE 1990-97	C4822	\$7.28

Gasket Kits



TOP END GASKET KIT



Application	Part #	List Price
5S-FE 1990-97 88mm Bore	PRO2042T	\$193.12

BOTTOM END GASKET KIT



Application	Part #	List Price
5S-FE 1990-97	PRO2042B	\$35.16



TOYOTA

22R/22R-TEC 2.4L 1982-85 Celica, 1981-95 Hi-Lux, 1981-82 Corona, 1984-95 4 Runner

Head Gasket

MLS Head Gasket

Bore	Thickness	Pkg Qty	Part #	List Price
93mm	.040"	1	C14086-040	\$97.27
94mm	.040"	1	C14074-040	\$97.27
95mm	.040"	1	C4269-040	\$97.27

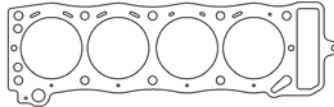

Additional thicknesses available see page 5

Individual Gaskets

Valve Cover Gasket Set

Application	Part #	List Price
22R 2.4L 81-85	C4935	\$17.66

Oil Pan Gasket

Application	Part #	List Price
22R 2.4L 81-85	C4940	\$14.39

Intake Manifold Gasket Set

Application	Part #	List Price
22R 2.4L 81-85	C4936	\$19.78

Water Pump Gasket Set

Application	Part #	List Price
22R 2.4L 81-85	C4941	\$6.51

Exhaust Manifold Gaskets

Application	Part #	List Price
22R 2.4L 81-82	C4937-064	\$18.73
22R 2.4L 83-84	C4938-064	\$18.73
22R 2.4L 85-87	C4939-064	\$25.07

Timing Cover Sets

Application	Part #	List Price
22R 2.4L 81-84	C4942	\$20.42
22R 2.4L 1985	C4943	\$19.79

Valve Stem Seals (sold individually)

Application	Part #	List Price
22R 2.4L 81-85	3157V	\$1.86

Rear Main Seal

Application	Part #	List Price
22R 2.4L 81-85	C4944	\$14.00

2RZ-FE 2.4L 1995-04, 3RZ-FE 2.7L 1997-04

Head Gaskets

MLS Head Gaskets

Bore	Thickness	Pkg Qty	Part #	List Price
96mm	.040"	1	C4598-040	\$97.27
97mm	.040"	1	C4245-040	\$97.27

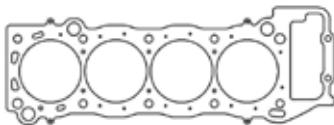

Additional thicknesses available see page 5

Individual Gaskets

Valve Cover Gasket Set

Application	Part #	List Price
2RZ/3RZ	C4830	\$23.56

Thermostat Gasket Set

Application	Part #	List Price
2RZ/3RZ	C4831	\$8.42

Intake Manifold Gaskets

Application	Part #	List Price
2RZ/3RZ 95-99	C4826-018	\$21.94
2RZ/3RZ 95-99 Plenum	C4827-032	\$21.94
2RZ/3RZ 99-04	C4828-032	\$26.85
2RZ/3RZ 99-04 Plenum	C4829-032	\$26.85

Oil Pan Gasket

Application	Part #	List Price
2RZ/3RZ	C4834	\$5.23

Timing Cover Sets

Application	Part #	List Price
2RZ/3RZ	C4833	\$3.72

Exhaust Manifold Gasket

Application	Part #	List Price
2RZ/3RZ MLS	C4207-030	\$28.07

Water Pump Gasket

Application	Part #	List Price
2RZ/3RZ	C4835-020	\$7.92

See page 151 for additional gaskets



TOYOTA

2RZ-FE 2.4L 1995-04, 3RZ-FE 2.7L 1997-04

Individual Gaskets

Valve Stem Seals (sold individually)		
Application	Part #	List Price
2RZ/3RZ.....	3225V	\$1.75

Rear Main Seal Set		
Application	Part #	List Price
2RZ/3RZ 97-04.....	C4832	\$28.76

Gasket Kits



TOP END GASKET KIT



Application	Part #	List Price
2RZ/3RZ 97-04 97mm Bore	PRO2043T	\$266.99

BOTTOM END GASKET KIT



Application	Part #	List Price
2RZ/3RZ 97-04	PRO2043B	\$70.40

2AZ-FE 2.4L DOHC 2002-09 Camry, 2009-11 Matrix, 2009-10 Pontiac Vibe, 2009-11 Corolla ZRS, 2002-09 Solara, 2004-08 RAV4, 2001-08 Highlander, 2005-10 Scion tC, 2008-12 Scion xB

Head Gaskets

MLS Head Gaskets				
Bore	Thickness	Pkg Qty	Part #	List Price
89mm027"	1.....	C4507-027	\$97.27
92mm027"	1.....	C4506-027	\$97.27

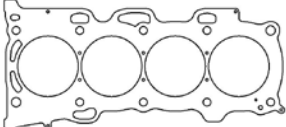

Additional thicknesses available see page 5

Individual Gaskets

Exhaust Manifold Gasket		
Application	Part #	List Price
2AZ-FE .030" MLS	C4203-030	\$24.69



TOYOTA

7M-GE/7M-GTE 3.0L Inline 6 24v 2954cc 1986-92 Supra, 1988-92 Cressida

Head Gaskets

MLS Head Gaskets

Bore	Thickness	Pkg Qty	Part #	List Price
84mm	.051"	1	C4278-051	\$182.40
86mm	.051"	1	C4275-051	\$182.40

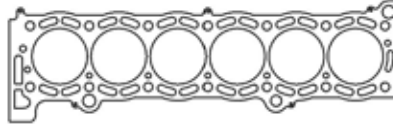

Additional thicknesses available see page 5

Individual Gaskets

Valve Cover Gasket Set

Application	Part #	List Price
7M-GE/GTE 86-92	C4838	\$23.56

Thermostat Gasket

Application	Part #	List Price
7M-GE/GTE 86-92	C4839	\$4.45

Intake Manifold Gasket Set

Application	Part #	List Price
7M-GE/GTE 86-92	C4837-031	\$16.31

Oil Pan Gasket

Application	Part #	List Price
7M-GE/GTE 86-92	C4845-062	\$17.36

Exhaust Manifold Gasket

Application	Part #	List Price
7M-GE/GTE 86-92 MLS	C4208-030	\$28.07

Timing Cover Set

Application	Part #	List Price
7M-GE/GTE 86-92	C4844	\$4.05

Cam Seal Set

Application	Part #	List Price
7M-GE/GTE 86-92 2pcs	C4808	\$11.60

Water Pump Gasket Set

Application	Part #	List Price
7M-GE/GTE 86-92	C4846-031	\$10.12

Valve Stem Seals (sold individually)

Application	Part #	List Price
7M-GE/GTE 86-92	3225V	\$1.75

Rear Main Seal Set

Application	Part #	List Price
7M-GE/GTE 86-92	C4843	\$19.05

Throttle Body Gasket

Application	Part #	List Price
7M-GE/GTE 86-92	C4836-032	\$5.96

Front Crank/Balance Shaft Seals

Application	Part #	List Price
7M-GE/GTE 86-92 Front Crank	C4945	\$5.17
7M-GE/GTE 86-92 Balance Shaft	C4946	\$5.73

Gasket Kits



TOP END GASKET KIT

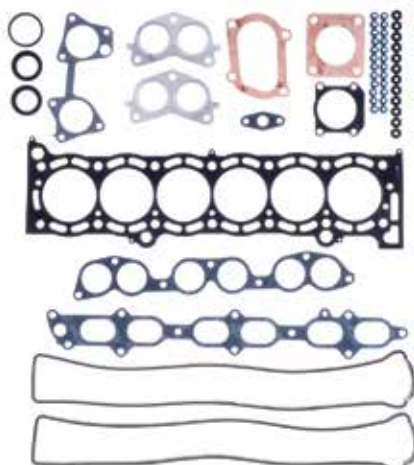

Application	Part #	List Price
7M-GE/GTE 86-92 84mm Bore	PRO2020T	\$226.08

BOTTOM END GASKET KIT

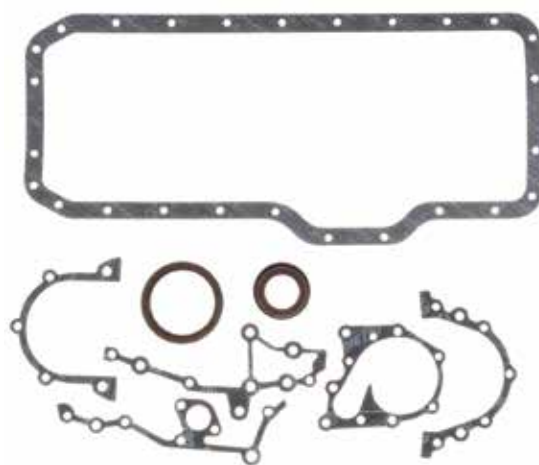

Application	Part #	List Price
7M-GE/GTE 86-92	PRO2020B	\$53.35



TOYOTA

1JZ-GE/GTE 2.5L Inline 6 24v

Head Gaskets

MLS Head Gaskets				
Bore	Thickness	Pkg Qty	Part #	List Price
87mm	.051"	1	C14036-051	\$182.40

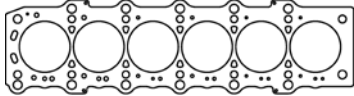

Additional thicknesses available
see page 5

Individual Gaskets

Turbo Exhaust Manifold Gasket		
Application	Part #	List Price
Turbo Exh. Manifold .060" thick, VVTi Only	C14119-060	\$21.12

Turbo Exhaust Manifold Gasket		
Application	Part #	List Price
Exhaust to Head - Includes 2 Non VVT.....	C14123-060	\$21.12

2JZ-GE/GTE 3.0L Inline 6 24v 1993-02 Supra, 1993-95 GS300, 1993-00 SC300

Head Gasket

MLS Head Gasket				
Bore	Thickness	Pkg Qty	Part #	List Price
87mm	.051"	1	C4276-051	\$182.40
87mm	.060"	1	C4276-060	\$218.44

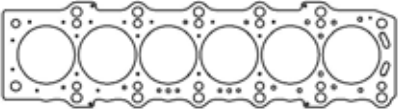

Additional thicknesses available
see page 5

MLX Head Gasket				
Bore	Thickness	Pkg Qty	Part #	List Price
87mm	.052"	1	C14016-052	\$207.99

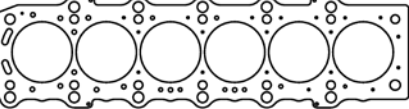

Individual Gaskets

Valve Cover Gasket Set		
Application	Part #	List Price
2JZ-GE/GTE.....	C4851	\$35.34

Throttle Body Gasket		
Application	Part #	List Price
2JZ-GE.....	C4848	\$5.97

Intake Manifold Gasket		
Application	Part #	List Price
2JZ-GE.....	C4849	\$105.89

Thermostat Gasket Set		
Application	Part #	List Price
2JZ-GE/GTE.....	C4852	\$5.94

Exhaust Manifold Gaskets		
Application	Part #	List Price
2JZ-GE .064" AM.....	C4847-064	\$38.33
2JZ-GTE .030" MLS.....	C4209-030	\$84.28

Water Pump Gasket		
Application	Part #	List Price
2JZ-GE/GTE.....	C4854-031	\$18.66

Cam Seal Set		
Application	Part #	List Price
2JZ-GE.....	C4850	\$15.07

Rear Main Seal		
Application	Part #	List Price
2JZ-GE/GTE.....	C4853	\$17.05

Valve Stem Seals (sold individually)		
Application	Part #	List Price
2JZ-GE/GTE.....	3225V	\$1.76

Oil Pan Gasket		
Application	Part #	List Price
Automatic Transmission	C14118-060	\$20.79

See page 154 for StreetPro gasket kits



TOYOTA

2JZ-GE/GTE 3.0L Inline 6 24v: 1993-02 Supra, 1993-03 GS300, 2001-03 IS300, 1993-00 SC300

Gasket Kits



TOP END GASKET KIT

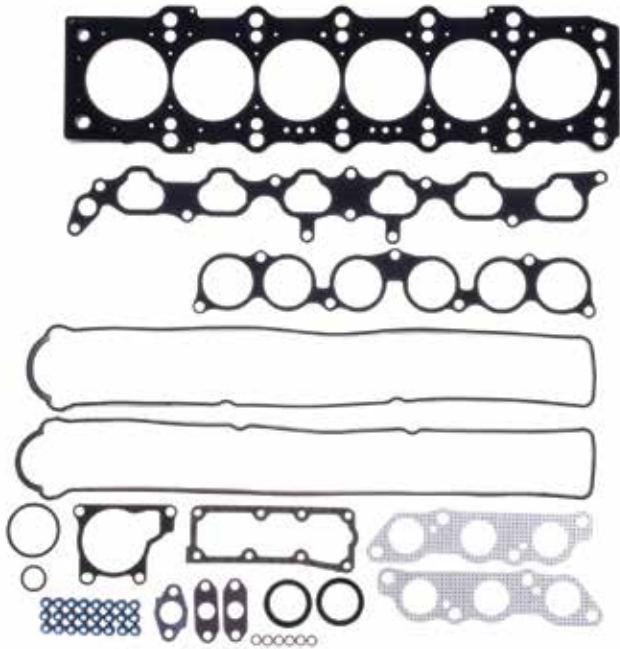

Application	Part #	List Price
2JZ-GE 93-98 87mm Bore	PRO2021T	\$373.80

BOTTOM END GASKET KIT



Application	Part #	List Price
2JZ-GE/GTE 93-98.....	PRO2021B	\$71.53

B58 3.0L Inline 6 B58B30C 2020 Toyota Supra

Head Gaskets

MLX Head Gasket

Bore	Thickness	Pkg Qty	Part #	List Price
83mm036"	1.....	C14144-036	\$182.40

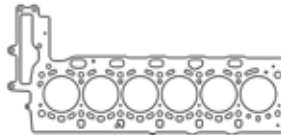

Additional thicknesses available
see page 5

5VZ-FE 3.4L V6 95-99 Tacoma, 95-98 T100, 95-99 4 Runner, 00-04 Tundra, 96-99 Landcruiser, 00 Hi-Lux

Head Gaskets

MLS Head Gasket - Left Side

Bore	Thickness	Pkg Qty	Part #	List Price
98mm040"	1.....	C4215-040	\$97.27

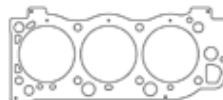

Additional thicknesses available
see page 5

MLS Head Gasket - Right Side

Bore	Thickness	Pkg Qty	Part #	List Price
98mm040"	1.....	C4214-040	\$97.27

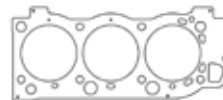



TOYOTA

1UZ-FE 4.0L 32v V8 w/o VVTi 98-00 GS400, 91-00 LS400, 91-00 SC400

Head Gaskets

MLS Head Gasket - Left Side

Bore	Thickness	Pkg Qty	Part #	List Price
89mm	.040"	1	C4137-040	\$102.11
92.5mm	.051"	1	C4137-051	\$102.11

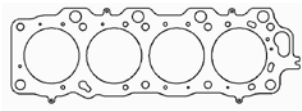

Additional thicknesses available
see page 5

MLS Head Gasket - Right Side

Bore	Thickness	Pkg Qty	Part #	List Price
89mm	.040"	1	C4136-040	\$102.11
92.5mm	.051"	1	C4136-051	\$102.11

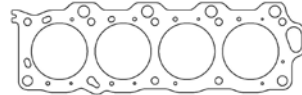

1UR-FE/1UR-FSE/2UR-FSE/2UR-GSE/3UR-FE/3UR-FBE 2006+

Head Gaskets

MLS Head Gasket - Left Side

Bore	Thickness	Pkg Qty	Part #	List Price
97mm	.034"	1	C4993-034	\$101.90

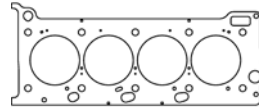

Additional thicknesses available
see page 5

MLS Head Gasket - Right Side

Bore	Thickness	Pkg Qty	Part #	List Price
97mm	.034"	1	C4994-034	\$101.90

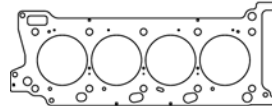

NEW!

Individual Gaskets

Exhaust Manifold Gasket Set

Application	Part #	List Price
1UR-FE/3UR-FBE/3UR-FE	C14125-040	\$64.27

2GR-FE 3.5L V6 3456cc 2005 Avalon, 2006 RAV4, 2008 Highlander

Head Gaskets

MLS Head Gasket - Left Side

Bore	Thickness	Pkg Qty	Part #	List Price
94.5mm	.045"	1	C4582-045	\$102.11

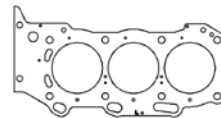

Additional thicknesses available
see page 5

MLS Head Gasket - Right Side

Bore	Thickness	Pkg Qty	Part #	List Price
94.5mm	.045"	1	C4581-045	\$102.11

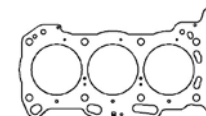

1GR-FE 4.0L V6: 4Runner 03-17, FJ Cruiser 07-09, Tacoma 05-15, Tundra 05-10, Landcruiser 02-11

Head Gaskets

MLS Head Gasket - Left Side

Bore	Thickness	Pkg Qty	Part #	List Price
95.5mm	.027"	1	C4556-027	\$102.11
96.5mm	.036"	1	C14054-036	\$102.11
96.5mm	.045"	1	C14054-045	\$102.11

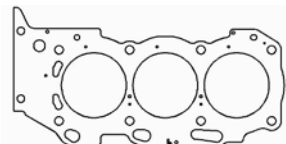

Additional thicknesses available
see page 5

See page 156 for additional gaskets



TOYOTA

1GR-FE 4.0L V6: 4Runner 03-17, FJ Cruiser 07-09, Tacoma 05-15, Tundra 05-10, Landcruiser 02-11

Head Gaskets

MLS Head Gasket - Right Side

Bore	Thickness	Pkg Qty	Part #	List Price
95.5mm	.027"	1	C4557-027	\$98.18
96.5mm	.036"	1	C14045-036	\$98.18
96.5mm	.045"	1	C14045-045	\$98.18



Additional thicknesses available see page 5

Individual Gaskets

Oil Pan Gasket

Application	Part #	List Price
05-17 Lower (1GR-FE/2GR/2TR-FE/2GR-FKS) Automatic Trans - 19 Bolt (1UZ/2UZ/7MGTE)	C14113-060	\$20.79
Automatic Trans - 20 Bolt (1UR/3UR/4GR-FSE)	C14122-060	\$20.79

Intake Manifold Gasket Set

Application	Part #	List Price
03-15 1GR-FE Set of 2	C14127-020	\$16.03

Exhaust Manifold Gasket Set

Application	Part #	List Price
07-15 1GR-FE Set of 2	C14116-064	\$19.99

1FZ-FE 4.5L DOHC Inline 6 1995-98 Landcruiser, 1995-98 Lexus 450

Head Gaskets

MLS Head Gasket

Bore	Thickness	Pkg Qty	Part #	List Price
101.5mm	.053"	1	C4530-053	\$218.44

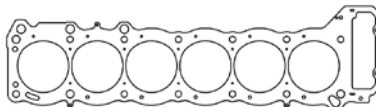

Additional thicknesses available see page 4

MLX Head Gasket

Bore	Thickness	Pkg Qty	Part #	List Price
101.5mm	.040"	1	C4611-040	\$243.84

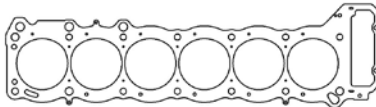

2UZ-FE 4.7L 32v V8 1998 Landcruiser, 2004 GX470, 2004 4 Runner, 2001-04 Tundra, 2001-04 Sequoia, 1998-00 LX470

Head Gaskets

MLS Head Gaskets - Left Side

Bore	Thickness	Pkg Qty	Part #	List Price
92mm	.040"	1	C4358-040	\$102.11
98mm	.040"	1	C4212-040	\$102.11

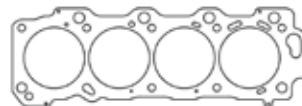

Additional thicknesses available see page 4

MLS Head Gaskets - Right Side

Bore	Thickness	Pkg Qty	Part #	List Price
92mm	.040"	1	C4357-040	\$102.11
98mm	.040"	1	C4211-040	\$102.11

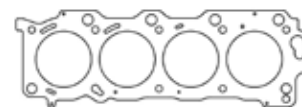

Individual Gaskets

Oil Pan Gasket

Application	Part #	List Price
Automatic Trans - 20 Bolt (1UR/3UR/4GR-FSE)	C14122-060	\$20.79



TOYOTA

PH11 Race V8

Head Gaskets

MLS Head Gasket - Left Side				
Bore	Thickness	Pkg Qty	Part #	List Price
4.200"040"1	C5584-040\$120.47



Additional thicknesses available
see page 5

MLS Head Gasket - Right Side				
Bore	Thickness	Pkg Qty	Part #	List Price
4.200"040"1	C5583-040\$120.47



TRIUMPH

1966-74 Spitfire 1500cc

Head Gasket

Copper Head Gasket				
Bore	Thickness	Pkg Qty	Part #	List Price
74mm043"1	C4153-043\$97.83

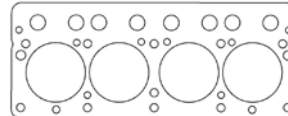

Additional thicknesses available
see page 5

1961-65 TR4 2138cc Pushrod

Head Gasket

CFM-20 Head Gasket				
Bore	Thickness	Pkg Qty	Part #	List Price
88mm043"1	C4152-043\$85.07

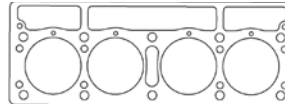

Additional thicknesses available
see page 5

1969-71 TR6 2498cc Inline 6 Pushrod

Head Gasket

Copper Head Gasket				
Bore	Thickness	Pkg Qty	Part #	List Price
76mm043"1	C4154-043\$97.83

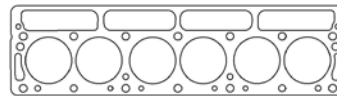

Additional thicknesses available
see page 5

TVR

Speed Six 3.6/4.0L: 1999-06 Tuscon, 1996-06 Cerbera, 2002-06 Tamora, 2002-06 T350, 2004-06 Sagaris

Head Gaskets

MLS Head Gasket				
Bore	Thickness	Pkg Qty	Part #	List Price
96.5mm060"1	C4527-060\$237.65

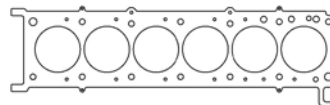

Additional thicknesses available
see page 5



VAUXHALL/OPEL

C16XE, X16XE, X16XEL, Y16XE: 1994-98 Astra, 1993-94 Corsa B GSI, 1994-00 Tigra 16v

Head Gasket

MLS Head Gasket

Bore	Thickness	Pkg Qty	Part #	List Price
82mm051"1	C4257-051\$97.27

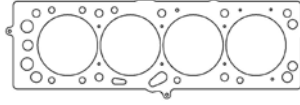

Additional thicknesses available
see page 5

20XE, C20XE, C20LET: 1992-97 Calibra Turbo, 1987-91 Kadett E 16v, 1993-95 Vectra A Turbo

MLS Head Gasket

Bore	Thickness	Pkg Qty	Part #	List Price
88mm051"1	C4216-051\$97.27

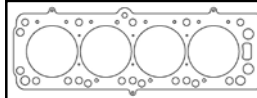

Additional thicknesses available
see page 5

MLX Head Gasket

Bore	Thickness	Pkg Qty	Part #	List Price
88mm050"1	C4960-050\$120.47

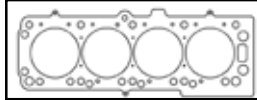

20E, 20N, 20S CIH 2.0L: 1983-88 Manta B, 1978-81 Ascona, 1976-80 Rekord, 1983-84 Monza, 1977-79 Kadett

Head Gasket

MLS Head Gasket

Bore	Thickness	Pkg Qty	Part #	List Price
97mm051"1	C4512-051\$164.48

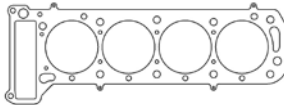

Additional thicknesses available
see page 5

VOLKSWAGEN/AUDI

1.4L 1390cc DOHC TFSI 2007+: BMY, BLG

Head Gaskets

MLX Head Gasket

Bore	Thickness	Pkg Qty	Part #	List Price
77mm032"1	C4980-032\$120.47

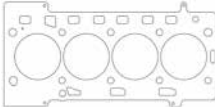

Additional thicknesses available
see page 5

Individual Gaskets

Exhaust Manifold Gasket Sets

Application	Part #	List Price
1.4L DOHC 16v MLS	C4975-030\$22.46

1.8L AGB, 2H, GX, HT, JH, JN, MZ, PG, PF, RD, RV, PL 2.0L: 9A - Golf Mk2/Mk3, Jetta Mk2/Mk3, Passat B2/B3/B4, Audi 80/100, Seat Ibiza Mk2

Head Gaskets

MLS Head Gaskets

Bore	Thickness	Pkg Qty	Part #	List Price
83mm051"1	C4247-051\$97.27
85mm051"1	C4246-051\$97.27

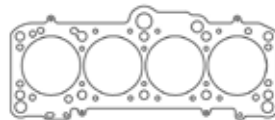

Additional thicknesses available
see page 5

Individual Gaskets

Exhaust Manifold Gasket Sets

Application	Part #	List Price
1.8L 8v MLS - 4pcs	C4163-030\$37.62
1.8L 16v MLS - 4pcs	C4210-030\$37.62



VOLKSWAGEN/AUDI

1.8L Turbo 1998-06 AEB, AGU, AJH, APH, ARX, ARZ, ATW, AUM, AVC, AWD, AWL, AWT, AWW, BJX, BKF, BKV, CFMA, AYP, CED, AMB, AWM, AJQ, APP, ARY, ATC, AUQ, AWP, BEK, BNU, BEX, BVR, AMU, AMK, BAM, BEA

Head Gaskets

MLS Head Gaskets

Bore	Thickness	Pkg Qty	Part #	List Price
82mm	.051"	1	C4558-051	\$97.27
85mm	.051"	1	C4559-051	\$97.27

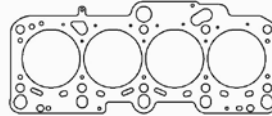

Additional thicknesses available
see page 5

2.0L TFSI 16v DOHC Golf GTI 2004-Up, A3, A4, A6, Jetta, Passat 2005-Up, TT, EOS 2006-Up, Seat Leon 2005-Up (AXX, BPY, BWA, BPJ, BUL, BWE, BRC, BWT, BYK)

Head Gasket

MLS Head Gasket

Bore	Thickness	Pkg Qty	Part #	List Price
83.5mm	.051"	1	C4541-051	\$97.27

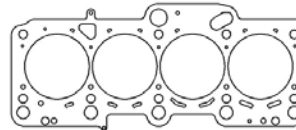

Additional thicknesses available
see page 5

Individual Gaskets

Exhaust Manifold Gasket Sets

Application	Part #	List Price
2.0L DOHC 16v MLS 2005-14	C4972-030	\$22.46

2.0L 16v DOHC 2008-11(chain driven) A3, A4, A6, A3, A4, A5, Q5, TT, 2009-11 CC, 08-11 Jetta, 08-10 Passat

Head Gaskets

MLS Head Gasket

Bore	Thickness	Pkg Qty	Part #	List Price
82.5mm	.040"	1	C4976-040	\$97.27
84mm	.040"	1	C4977-040	\$97.27

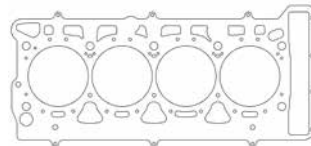

Additional thicknesses available
see page 5

Individual Gaskets

Exhaust Manifold Gasket Sets

Application	Part #	List Price
2.0L DOHC 16v MLS 2005-14	C4972-030	\$22.46

2.0L 8v EA113 1998-2015

Head Gaskets

NEW!

MLS Head Gasket

Bore	Thickness	Pkg Qty	Part #	List Price
84mm	.040"	1	C14124-040	\$97.27



Additional thicknesses available
see page 5



VOLKSWAGEN/AUDI

2.0L 16v DOHC 2012-Present (chain driven): A1, A3, A4, A5, Q3, Q5, TT

Head Gaskets

MLS Head Gasket

Bore	Thickness	Pkg Qty	Part #	List Price
83mm	.040"	1	C4978-040	\$97.27
84mm	.040"	1	C4979-040	\$97.27

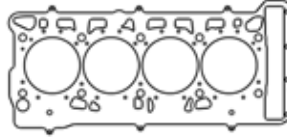

Additional thicknesses available
see page 5

Individual Gaskets

Exhaust Manifold Gasket Sets

Application	Part #	List Price
2.0L DOHC 16v MLS 2005-14	C4972-030	\$22.46

**1.8L 16V DOHC (CNSA, CNSB, CPRA, CPKA, CXBA, CXBB)
2.0L 16v DOHC (CJXC, CXBB, CXCA, CNTC, CPPA, CPLA, CXCB, CYFB, CYMC,
CYNB, CZRA, DBPA, EA113)**

Head Gaskets

MLX Head Gasket

Bore	Thickness	Pkg Qty	Part #	List Price
83mm	.036"	1	C14009-036	\$120.47

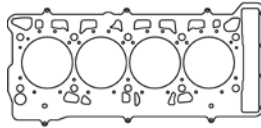

Additional thicknesses available
see page 5

2.5L 20V TFSI DAZA, DNWA

Head Gaskets

NEW!

MLS Head Gasket

Bore	Thickness	Pkg Qty	Part #	List Price
83.5mm	.055"	1	C14145-055	\$161.13

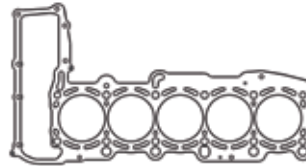

Additional thicknesses available
see page 5

3.2L VR6 24v 2004-09: Golf Mk4 R32

Head Gaskets

MLS Head Gasket

Bore	Thickness	Pkg Qty	Part #	List Price
83mm	.030"	1	C4968-030	\$114.86

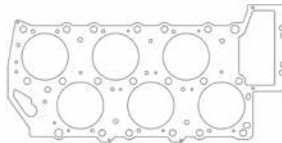

Additional thicknesses available
see page 5

Individual Gaskets

Throttle Body Gasket

Application	Part #	List Price
3.2L VR6	C14027-060	\$5.96

Intake Manifold Gasket

Application	Part #	List Price
2007-08 Eos, 2003-04 Golf	C14029-060	\$21.94



VOLVO

B18A/B/D 1.8L 1961-68, B20A/B/E/F 2.0L 1969-81

Head Gasket

MLS Head Gasket				
Bore	Thickness	Pkg Qty	Part #	List Price
86mm	.045"	1	C4287-045	\$121.56
90mm	.045"	1	C4288-045	\$121.56
92mm	.045"	1	C4289-045	\$121.56

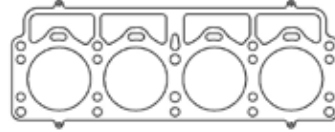

Additional thicknesses available
see page 5

B19A/E/ET 2.0L 1976-84, B200E/ET/F/K 2.0L 1985-95, B21E/F/FT 2.1L 1975-85

Head Gasket

MLS Head Gasket				
Bore	Thickness	Pkg Qty	Part #	List Price
92mm	.045"	1	C4498-045	\$121.56
92mm	.098"	1	C4498-098	\$158.03
93mm	.045"	1	C14085-045	\$121.56

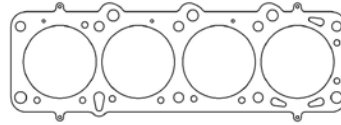

Additional thicknesses available
see page 5

B23A/E/F/FT/K 2.3L 1978-84, B230A/E/F/FT/K 2.3L 1985-98, B234F 1989-95

Head Gasket

MLS Head Gasket				
Bore	Thickness	Pkg Qty	Part #	List Price
97mm	.045"	1	C4499-045	\$121.56
98mm	.051"	1	C14094-051	\$121.56
100.5mm	.045"	1	C14093-045	\$121.56

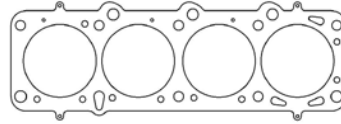

Additional thicknesses available
see page 5



MLS

Exhaust Manifold Gaskets

- Designed for extreme cylinder pressures
- Maintains a torque set
- Resists corrosion, will not burn through or push out
- Withstands different combinations of cylinder head & exhaust manifold materials
- No sealants are required



Domestic Exhaust Gaskets

Description	Material	Pkg Qty	Part#	List
CHRYSLER / DODGE				
318, 340 & 360				
1.310" x 1.640" Port	MLS .030"	2	C5901-030	\$46.05
361, 383, 400, 413, 426 & 440				
1.780" x 1.460" Port	MLS .030"	2	C5902-030	\$49.83
426 Hemi				
1.840" x 1.890" Port Stock	MLS .030"	2	C5965-030	\$42.57
2.310" x 2.810" Port Top Fuel	MLS .030"	2	C5903-030	\$48.30
5.7L Hemi V8				
1.460" x 1.390" Port	MLS .030"	2	C5854-030	\$40.09
6.1L Hemi V8				
2.082" x 1.508" Port	MLS .030"	2	C5872-030	\$42.68
6.1/6.2/6.4L Hemi V8 Gen-3				
1.989" x 1.409" Port	MLS/HT .090"	2	C15642-090	\$102.25
Viper V10				
Gen I 1992-96	MLS .030"	2	C5679-030	\$34.48
Gen II 1996-02	MLS .020"	2	C5825-020	\$34.48
Gen III 2003-07	MLS .030"	2	C5865-030	\$34.48
Gen IV 2008-12	MLS .040"	2	C15150-040	\$56.12
CUMMINS				
5.9L 12V I6 Diesel 92-97	MLS .040"	2	C5725-040	\$51.73
5.9L 24V / Common Rail 98-08	MLS .040"	2	C5726-040	\$51.73
FORD				
289, 302 & 351				
1.120" x 1.480" Port Square	MLS .030"	2	C5898-030	\$42.68
1.127" x 1.750" Port Oval	MLS .030"	2	C5899-030	\$42.68
All Yates Head 3 Piece Spring Steel	MLS .040"	8	C5665-040	\$40.09
332 & 390				
1.560" x 2.320" Port	MLS .030"	2	C5922-030	\$49.50
4.6L DOHC & SOHC, 5.4L SOHC				
4.6L / 5.4L 3V Head	MLS .030"	2	C5852-030	\$40.59
4.6L / 5.4L 3V Head D-Ports	MLS .030"	2	C5997-030	\$40.59
4.6L SOHC 1991-01, 5.4L Triton 99-Up	MLS .030"	2	C5853-030	\$37.62
4.6L / 5.4L DOHC 93-99	MLS .030"	2	C5012-030	\$41.39
5.0L Modular V8 2011	MLS .030"	2	C5392-030	\$48.39
5.2L DOHC Voodoo V8 2015-2020	MLS .030"	2	C15601-030	\$48.39
5.4L Shelby Mustang 2007	MLS .030"	2	C5805-030	\$47.48
6.2L "BOSS" V8 2010+	MLS .030"	2	C5041-030	\$60.72
429 & 460				
1.250" x 2.080" Oval Port	MLS .030"	2	C5900-030	\$47.17
1.550" x 2.350" Oval Port	MLS .030"	2	C5998-030	\$47.17
RACE				
JC50 500ci - Pro Stock	MLS .030"	2	C5257-030	\$60.72
FR9 V8	MLS .030"	2	C15107-030	\$60.72
DIESEL				
6.0/6.4L Power Stroke	MLS .030"	2	C5089-030	\$51.73
Ford 6.7L Power Stroke 11-14	MLS .030"	2	C15487-030	\$45.82
GM				
V8 Small Block 262, 265, 283, 302, 307, 327, 350, 400 & LT1				
1.400" Square Port	MLS .030"	2	C5548-030	\$42.68
1.500" Round Port	MLS .030"	2	C5891-030	\$42.68
1.450" x 1.480" Port	MLS .030"	2	C5892-030	\$42.68
1.625" Round Port	MLS .030"	2	C5893-030	\$43.82
1.450" x 1.600" Port	MLS .030"	2	C5894-030	\$43.82
LT1 1.520" x 1.510" Port	MLS .030"	2	C5895-030	\$44.94
Brodix 12B Raised D Port	MLS .030"	2	C5927-030	\$44.94
Brodix / Weldtech 12 x 12 D Port	MLS .030"	2	C5928-030	\$44.94
GM/Brodix 13 Degree 4.4/4.5" Spacing	MLS .030"	2	C5039-030	\$39.59
Brodix/All Pro 286	MLS .030"	2	C5040-030	\$39.59
SB2 Race				
1.500" x 1.600"	MLS .065"	2	C5552-065	\$36.45
SB2	MLS .030"	2	C5836-030	\$57.81
Big Block				
1.920" Round Port	MLS .030"	2	C5896-030	\$46.05
2.000" Round Port	MLS .030"	2	C5349-030	\$46.05
2.130" Round Port	MLS .030"	2	C5996-030	\$46.05
2.200" Round Port	MLS .030"	2	C5350-030	\$46.05
2.250" Round Port	MLS .030"	2	C5251-030	\$46.05
1.850" x 1.900" Port	MLS .030"	2	C5897-030	\$46.05

Description	Material	Pkg Qty	Part#	List
GM				
Mercury Big Block 1050				
Mercury Marine 525/552 EFI	MLS .051"	2	C5820-051	\$72.87
LS Series V8				
LS7 D-Port 06-14	MLS .030"	2	C5073-030	\$37.62
GEN V LT1 6.2L 1.920" Port	MLS .021"	2	C5020-021	\$52.10
DIESEL				
6.6L Duramax 01-16	MLS .040"	2	C15042-040	\$56.15
PONTIAC				
Pontiac V8 326, 350, 400, 421, 428 & 455 D Port				
330, 350, 400, 403 & 455	MLS .030"	2	C5905-030	\$46.05
OLDS				
1.450" x 1.920" Port	MLS .030"	2	C5904-030	\$46.05
UNIVERSAL Header Collector				
3.000" Dia. x 3.875" Bolt Circle	MLS .030"	2	C5907-030	\$20.19

Import Exhaust Gaskets

Description	Material	Pkg Qty	Part#	List
GM				
Ecotec 2.2L - 1.720" x 1.090" 00-Up	MLS .030"	1	C4150-030	\$24.69
HONDA				
All B Series - 1.850" x 1.340" 94-01	MLS .030"	1	C4151-030	\$20.19
H22A1/A2/A4 - 1.770" x 1.380" 92-01	MLS .030"	1	C4155-030	\$30.32
F20C1/C2 - 2.030" x 1.730" 00-Up	MLS .030"	1	C4159-030	\$24.69
K20A1/A3 - 1.820" x 1.540" 01-04	MLS .030"	1	C4160-030	\$24.69
K20A2 - 1.975" x 1.730" 02-06	MLS .030"	1	C4162-030	\$24.69
K20C1 - 3.26" x 1.66" 17-20	MLS .020"	1	C14022-020	\$14.34
D15/16 - 1.860" x 1.390" 92-00	MLS .030"	1	C4164-030	\$24.69
MAZDA				
B6 16V - 1.765" x 1.020" 89-93	MLS .030"	1	C4165-030	\$33.65
FS-DE - 2.045" x 1.375" 91-03	MLS .030"	1	C4171-030	\$28.07
MITSUBISHI				
4G63T/4G64 - 2.287" x 1.615" 89-99	MLS .030"	1	C4199-030	\$24.69
420A - 2.040" x 1.100" 95-98	MLS .030"	1	C4161-030	\$24.69
NISSAN				
VK56XD 2010-16	MLS .030"	2	C4959-030	\$60.74
VK56DE 2004-09	MLS .030"	2	C4961-030	\$60.74
CA18 DOHC - 1.621" x 1.232"	MLS .030"	1	C4523	\$34.86
SR20DE/T - 2.050" x 1.580" 91-02	MLS .030"	1	C4200-030	\$30.32
KA24DE - 1.575" Square 91-98	MLS .030"	1	C4201-030	\$30.32
RB26 - 1.665" x 1.420" 89-02	MLS .030"	2	C4202-030	\$28.07
RB20/RB25 - 1.340" x 1.575"	MLS .030"	1	C4177-030	\$28.07
SCION				
2AZ-FE 2.4L - 1.890" Round 01-Up	MLS .030"	1	C4203-030	\$24.69
SUBARU				
All EJ Motors - 1.825" Round 93-Up	MLS .030"	2	C4204-030	\$18.64
TOYOTA				
1ZZFE - 1.732" Round 98-02	MLS .030"	1	C4205-030	\$24.69
3S-GTE/5S-FE - 1.690" x 1.415" 89-97	MLS .030"	1	C4206-030	\$30.65
2RZ/3RZ-FE - 1.730" x 1.460" 95-Up	MLS .030"	1	C4207-030	\$28.07
7MGTE - 1.412" Round 87-92	MLS .030"	1	C4208-030	\$28.07
2JZGTE - 1.600" x 1.220" 93-Up	MLS .030"	2	C4209-030	\$84.28
1UR-FE/3UR-FBE/3UR-FE 07-19	MLS .040"	1	C14125-040	\$64.27
VW/AUDI				
2.0L 05-14	MLS .030"	1	C4972-030	\$22.46
1.4L 07-Up	MLS .030"	1	C4975-030	\$22.46
2.0L - 1.525" Round 85-96	MLS .030"	4	C4210-030	\$37.62



Valve Stem Seals

Available for most applications ranging from automotive to off road dirt bikes.
Valve stem seals are defined first by the actual measurement of the valve stem OD itself then by the guide OD. Proper seal height and width will be determined by valve spring clearance.
Sold in packs of sixteen.



Umbrella



Positive All Rubber



Positive Ring & Spring



Positive Ring & Band



O-Ring



Metal Jacket



Metal Jacket "Hat"

Metric Valve Stem

Part #	Stem OD	Guide OD	Height	OD	Type / Matl.	Retail
3154V-16	8.0mm	12.0mm	9.6mm	15.5mm	Metal Jacket/Viton	\$34.58
3158V-16	6.0mm	10.7mm	11.5mm	13.8mm	Metal Jacket/Viton	\$24.06
3159V-16	6.0mm	11.75mm	15.0mm	14.6mm	Metal Jacket/Viton	\$24.06
3162V-16	7.0mm	15.0mm	14.0mm	14.3mm	Metal Jacket/Viton	\$41.88
3163V-16	5.5mm	11.8mm	12.0mm	14.8mm	Metal Jacket/Viton	\$39.93
3164V-16	8.0mm	12.3mm	12.0mm	17.0mm	Ring & Band/Viton	\$34.04
3168V-16	7.5mm	14.0mm	13.0mm	16.8mm	Metal Jacket/Viton	\$41.49
3169V-16	5.5mm	12.0mm	13.8mm	14.5mm	Metal Jacket/Viton (no int rubber)	\$26.92
3170V-16	5.0mm	11.0mm	10.0mm	12.85mm	Metal Jacket/Viton	\$22.82
3172V-16	6.0mm	9.8mm	10.0mm	13.2mm	Metal Jacket/Viton	\$47.94
3173V-16	5.5mm	11.8mm	12.0mm	14.75mm	Metal Jacket/Viton	\$34.23
3225V-16	6mm	11mm	9.3mm	13.4mm	Metal Jacket/Viton	\$26.52
3174V-16	8.5mm	12.5mm	2.0mm	11.9mm	O-ring/Viton	\$6.42
3175V-16	5.5mm	9.5mm	11.4mm	12.75mm	Metal Jacket/Viton	\$24.06
3176V-16	5.0mm	10.6mm	11.6mm	14.15mm	Metal Jacket/Viton	\$37.96
3177V-16	6.0mm	12.0mm	10.0mm	13.7mm	Metal Jacket/Viton	\$39.93
3180V-16	5.0mm	10.8mm	18.3mm	16.9mm	Metal Jacket (Hat)/Viton	\$33.79
3181V-16	5.5mm	11.6mm	20.2mm	17.2mm	Metal Jacket (Hat)/Viton	\$46.34
3182V-16	5.0mm	11.8mm	21.0mm	17.15mm	Metal Jacket (Hat)/Viton	\$49.91
3262V-16	7.0mm	11mm	9.5mm	14.4mm	Metal Jacket/Viton	\$28.34
3264V-16	5.0mm	11mm	8mm	13.4mm	Metal Jacket EXH/Viton	\$29.95
3265V-16	5.0mm	11mm	8mm	13.4mm	Metal Jacket INT/Viton	\$80.22
3516P-16	8.0mm	0.492	0.470	0.616	Metal Jacket/Poly	\$27.62

1/4" Valve Stem

Part #	Stem OD	Guide OD	Height	OD	Type / Matl.	Retail
3184V-16	1/4	0.435	0.392	0.531	Metal Jacket/Viton	\$28.69
3232V-16	1/4	0.476	0.517	0.562	Metal Jacket/Viton (no int rubber)	\$26.92
3258V-16	1/4	0.476	0.646	1.106	Metal Jacket (Hat)/Viton	\$17.64
3259V-16	1/4	0.48	0.794	1.106	Metal Jacket (Hat)/Viton	\$17.83

5/16" Valve Stem

Part #	Stem OD	Guide OD	Height	OD	Type / Matl.	Retail
3057V-16	5/16	0.438	0.445	0.600	Ring & Band/Viton	\$49.91
3060V-16	5/16	0.562	0.461	0.710	Ring & Band/Viton	\$44.74
3061V-16	5/16	0.562	0.461	0.710	Ring & Band/Viton	\$44.74
3064V-16	5/16	0.563	0.580	0.712	Metal Jacket/Viton	\$64.17
3222V-16	5/16	0.514	0.403	0.610	Metal Jacket/Viton	\$28.69
3235V-16	5/16	0.531	0.516	0.677	Metal Body/Viton	\$32.44
3236V-16	5/16	0.491	0.531	0.623	Metal Body/Viton	\$34.23
3237V-16	5/16	0.476	0.517	0.562	Metal Body/Viton (no int rubber)	\$26.92
3216V-16	5/16	0.562	1.085	1.3888	Metal Jacket (Hat)/Viton	\$65.73

11/32" Valve Stem

Part #	Stem OD	Guide OD	Height	OD	Type / Matl.	Retail
3012V1-16	11/32	0.500	0.540	0.640	Ring & Band/Viton	\$32.61
3013N1-16	11/32	0.520	0.470	0.690	Positive 2-Ring/Nitrile	\$7.30
3014N1-16	11/32	0.530	0.485	0.710	Ring & Band/Nitrile	\$8.02
3024V1-16	11/32	0.530	0.485	0.710	Ring & Band/Viton	\$34.40
3066V1-16	11/32	0.563	0.470	0.690	Ring & Band/Viton	\$31.73
3188V-16	11/32	0.500	0.531	0.623	Metal Jacket/Viton	\$30.13
3192V-16	11/32	0.562	0.485	0.677	Ring & Band/Viton	\$32.44
3223V-16	11/32	0.472	0.435	0.677	Metal Jacket/Viton	\$28.69
3228V-16	11/32	0.530	0.527	0.674	Metal Jacket/Viton	\$34.04
3245V-16	11/32	0.583	0.400	0.740	Metal Jacket/Viton	\$26.02

3/8" Valve Stem

Part #	Stem OD	Guide OD	Height	OD	Type / Matl.	Retail
3017N1-16	3/8	0.623	0.470	0.790	Positive-2-Ring/Nitrile	\$15.94
3050V-16	3/8	0.750	0.830	0.875	Umbrella Seal/Viton	\$32.80
3185T-16	3/8	0.562	0.415	0.66	Teflon Steel Body/Teflon	\$27.27
3195V-16	3/8	0.500	0.531	0.623	Metal Jacket/Viton	\$28.69
3196V-16	3/8	0.530	0.516	0.677	Metal Jacket/Viton	\$32.44
3197V-16	3/8	0.562	0.516	0.661	Metal Jacket/Viton	\$28.69
3198V-16	3/8	0.625	0.531	0.742	Metal Jacket/Viton	\$32.44

Misc. Valve Stem

Part #	Stem OD	Guide OD	Height	OD	Type / Matl.	Retail
3199V-16	0.276	0.476	0.517	0.562	Metal Jacket/Viton (no int rubber)	\$26.92
3240V-16			0.975	0.970	Metal Jacket (Hat)/Viton	\$63.11
3255V-16	0.287	0.49	0.887	1.185	Metal Jacket (Hat) INT/Viton	\$25.31
3256V-16	0.287	0.49	0.887	1.185	Metal Jacket (Hat) EXH/Viton	\$25.31
3260V-16	0.281	0.53	1.035	1.372	Metal Jacket (Hat)/Viton	\$66.84
3261V-16	0.281	0.53	1.14	1.255	Metal Jacket (Hat)/Viton	\$43.49
3214V-16	0.265	0.500	0.555	0.645	Metal Jacket /Intake	\$40.45
3215V-16	0.265	0.500	0.555	0.638	Metal Jacket /Exhaust	\$52.79
3217V-16	0.265		1.020	1.000	Metal Jacket (Hat)/Viton	\$73.87
3218V-16	0.265	0.500	0.635	1.126	Metal Jacket /Intake/Yellow	\$33.43
3219V-16	0.265	0.500	0.635	0.645	Metal Jacket /Exhaust/Green	\$33.34
3246V-16	0.198	0.334	0.390	0.482	Metal Jacket /Viton	\$24.68
3257V-16	0.204		0.555	0.645	Metal Jacket /Viton	\$40.02



WARNING: Cancer and Reproductive Harm www.P65Warnings.ca.gov



Fel-Pro to Cometic Cross Reference

Fel-Pro	Cometic	Fel-Pro	Cometic	Fel-Pro	Cometic	Fel-Pro	Cometic
1003	C5272-040	1827	C15092	CS8180-2	PRO1045B	TCS45906	C4816
1008	C5456-040	1839	C5104-094	CS8523	PRO1046B	TCS45907	C4816
1009	C5462-040	1863	C15607	HS26550PT	PRO1049T	TCS45953	C5054
1013	C5871-040	1866	C15077	HS26568PT	PRO1048T	TCS45956	C5055
1014	C5249-040	1900	C5263FC	HS8523PT-2	PRO1047T	TCS45996	C5060
1016	C5712-040	1901	C5262	HS9502PT	PRO1046T	TCS46049	C5202
1018	C5667-040	1935	C15616	MS90175	C5611-060	TCS5124-1	C5052
1020	C5840-040	2302	C5848-032	MS91484	C4671-060	TOS18583	C15246
1021	C5481-040	2324	C15615	MS91485	C4666	TOS18608	C15252
1028	C5668-040	2400	C15619	MS92504	C4674	TOS18621	C15253
1034	C15498-040	2900	C5680	MS93362	C4707-046	TOS18628	C15249
1035	C5709-040	2901	C5688	MS93909	C4205-030	TOS18633	C15254
1043	C15604-040	2904	C5682	MS94119-2	C4702-060	TOS18634	C15248
1046	C5485-051	2912	C5680	MS96476	C14095	TOS18663	C15251
1047	C5333-040	2919	C5106	MS96477	C4668	TOS18667	C15469
1067	C5334-040	5152	C15618	MS96587	C5166	TOS18679	C15247
1133	C5481-040	5152	C5299-018	MS96788	C15042-040	TOS18698	C15250
1135	C15622-040	5182	C15617	MS97402	C15599	VS50068R	C5659-125
1144	C5249-040	6579	C5642-031	OS30542R	C4660	VS50090R	C5975
1152	C5911-045	12222	C5165	OS30693R	C5173	VS50184R	C15468
1200	C5694-060	30060	C5347-039	OS30787	C14114-060	VS50279B	C4800-059
1201	C5792-060	35062	C5538-047	OS34500R	C5072	VS50293R	C15206
1204	C5544-060	61697	C15441	RDS13089	C15214	VS50304R1	C4820
1205	C15580-060	70194	C5531-060	RDS13270	C15222	VS50326R	C4701
1206	C15609-060	1011-1	C5514-040	RDS13314-1	C15216	VS50361R	C4781
1210	C15041-060	1011-2	C5514-040	RDS13391	C15227	VS50362R	C4679
1212	C15041-060	1017-1	C5330-040	RDS13889	C15212	VS50377R	C5178
1230	C5043-060	1017-2	C5330-051	RDS55008	C15226	VS50377R1	C5178
1231	C5206-060	1135SD-4	C15624-041	RDS55019	C15213	VS50384R	C4747
1234	C5598-060	1141L	C5118-036	RDS55028-1	C15232	VS50390R	C4722
1262	C15610-060	1141R	C5119-036	RDS55029	C15228	VS50396R	C15066-1
1277	C5541-031	1144-053	C5249-051	RDS55029	C15228FC	VS50455R	C15046
1282	C5541-060	1153-1	C4235-051	RDS55047	C15220	VS50477R	C5177
1298	C5342-060	1206-S3	C15614-059	RDS55063	C15234	VS50498R	C4628
1404	C15612-060	1884R	C15550	RDS55072	C15229	VS50499R	C4655
1405	C15611-060	23021-1	C15605-032	RDS55075	C15231	VS50504R	C5170
1423	C5147-064	26182PT	C4558-045	RDS55341	C15223	VS50574R	C4788
1470	C5895-030	26192PT	C5489-051	RDS55387	C15233	VS50581R	C4644
1628	C5973	26208PT	C5015-075	RDS55390	C15230	VS50625R	C5193
1628	C5973-2	26209PT	C5016-075	RDS55391	C15219	VS50811R	C15576
1628	C5973PR	BS40245	C5564	RDS55394	C15221	VS50820R	C15151
1635	C5975	BS40345-1	C4843	RDS55447	C15218		
1644	C15608	BS40444	C4697	RDS55476	C15225		
1649	C15613-188	BS40562	C4720	RDS6095-1	C15217		
1658	C15440	BS40613	C5707	RDS6629	C15215		
1684	C5974	BS40634	C4783	TCS13198	C5053		
1804	C5344	BS40637	C4832	TCS13417	C5070		
1810	C5279-094	BS40640	C5172	TCS45002	C5050		
1811	C5278-094	BS40648	C4699	TCS45060	C5057		
1818	C5294	CS26550-1	PRO1049B	TCS45061	C5066		
1821	C5488-060	CS26568	PRO1048B	TCS45117	C5047		



Karting Gaskets

BRIGGS & STRATTON

Model	Year	Bore Size	Top End Kit #	List Price	Component #	Component Description	List Price	OEM Part #
5HP RAPTOR	All	68.5mm	C104	\$23.21	H0694043F	68.5mm Bore Head Gasket Comp. Fiber	\$5.95	
					IR081047F	Intake Gasket (1.400" Spacing)	\$1.25	
					IR084015F	Carburetor Mount Gasket Tillotson	\$1.25	
					IR085125KF	Intake Gasket (1.800" Spacing)	\$1.25	
					EX113020C	Exhaust Gasket Copper	\$2.60	
					EX113042AM	Exhaust Gasket Armor	\$2.22	
					CB021060F	Fuel Tank Mounting Gasket	\$1.25	
					CB023015R	Carburetor Diaphragm Gasket	\$2.22	
					EC102047F	Breather Cover Gasket	\$1.25	
					EC103015F	Side Cover Gasket .015"	\$2.00	
EC103020F	Side Cover Gasket .020"	\$2.00						

• Suggested Oil: Klotz KL-870

ANIMAL	All	69.5mm	C187	\$35.72	H3590040S	69.5mm Head Gasket Multi-Layer Steel	\$20.01	555698
			C200	\$35.72	H3590SP1040S	70.5mm Head Gasket Multi-Layer Steel	\$20.01	555698
		70.5mm			IR786060AFM	Intake Gasket	\$1.25	691885
					EC1424060AFM	Cylinder Head Plate Gasket	\$1.25	694088
					EC1426060AFM	Breather Cover Gasket	\$5.54	691890
					EC1425032AFM	Side Cover Gasket	\$7.84	699485

• Suggested Oil: Klotz KL-870

LO206	All	69.5mm	C199	\$35.72	H3590SP2060HTS	69.5mm Head Gasket Graphite	\$19.69	555723
					IR786060AFM	Intake Gasket	\$1.25	691885
					EC1424060AFM	Cylinder Head Plate Gasket	\$1.25	694088
					EC1426060AFM	Breather Cover Gasket	\$5.54	691890
					EC1425032AFM	Side Cover Gasket	\$7.84	699485

• Suggested Oil: Klotz KL-870

WORLD FORMULA	All	69.5mm	C188	\$38.25	H3590040S	69.5mm Head Gasket Multi-Layer Steel	\$20.01	555698
					IR1376015F	Intake Gasket	\$1.25	557044
					EX1676059F	Exhaust Gasket	\$2.53	691893
					EC1424060AFM	Cylinder Head Plate Gasket	\$1.25	694088
					EC1426060AFM	Breather Cover Gasket	\$5.54	691890
					EC1425032AFM	Side Cover Gasket	\$7.84	699485

• Suggested Oil: Klotz KL-870

HONDA

Model	Year	Bore Size	Top End Kit #	List Price	Component #	Component Description	List Price	OEM Part #
GX200 CLONE	All	68mm	C192	\$41.11	H3096010S	68mm Head Gasket	\$15.02	
					IR836020F	Intake Gasket	\$1.25	
					CB307020F	Carburetor Flange Gasket	\$3.95	
					IR1381094KF	Air Filter Adapter Gasket	\$2.91	
					EX1033042AM	Exhaust Gasket	\$4.78	
					VC207047KF	Valve Cover Gasket	\$5.55	
					EC1453020F	Side Cover Gasket	\$11.88	

• Suggested Oil: Klotz KL-870

STOCK SHIFTER CR125	97-99	55mm	C189	\$52.97	H0225010S	55mm Head Gasket	\$18.08	12251-KZ4-A91
					B0314018AFM	Base Gasket	\$5.55	12191-KZ4-L10
					B0009018AFM	Base Gasket '97 Cylinders Only	\$5.55	2191-KZ4-860
					IR003018AFM	Intake Reed Gasket	\$3.95	14132-K56-701
					EX006042AM	Exhaust Gasket	\$4.84	18291-KZ4-700
					PV001018AFM	Right Power Valve Gasket	\$3.95	12108-KZ4-700
					PV002018AFM	Left Power Valve Gasket	\$3.95	12109-KZ4-700
					PV003018AFM	Upper Power Valve Gasket	\$3.95	12112-KZ4-700
					R19X3V	Water Outlet O-ring	\$3.14	91312-KE7-003

• Suggested Oil: Klotz KL-104

STOCK SHIFTER CR125	00	54mm	C190	\$41.11	H0928010S	54mm Head Gasket	\$18.08	12251-KZ4-A91
					B0314018AFM	Base Gasket	\$5.55	12191-KZ4-L10
					IR003018AFM	Intake Reed Gasket	\$3.95	14132-K56-701
					EX006042AM	Exhaust Gasket	\$4.84	18291-KZ4-700
					PV091032AFM	Power Valve Gasket	\$5.55	12108-KZ4-A90
					R19X3V	Water Outlet O-Ring	\$3.14	91312-KE7-003

• Suggested Oil: Klotz KL-104

STOCK SHIFTER CR125	01-02	54mm	C191	\$51.01	H0928010S	54mm Head Gasket	\$18.08	12251-KZ4-A91
					B0490018AFM	Base Gasket	\$7.68	12191-KZ4-L10
					EX006042AM	Exhaust Gasket	\$4.84	18291-KZ4-700
					IR003018AFM	Intake Gasket Reed To Carb Boot	\$3.95	14132-K56-701
					PV091032AFM	Power Valve Gasket	\$5.55	12108-KZ4-A90
					R124S	Expansion Cham O-Rings (2 Req.)	\$3.89	
					R19X3V	Water Outlet O-Ring	\$3.14	91312-KE7-003

• Suggested Oil: Klotz KL-104



WARNING: Cancer and Reproductive Harm www.P65Warnings.ca.gov



Karting Gaskets

HONDA

Model	Year	Bottom End Kit #	List Price	Component #	Component Description	List Price	OEM Part#
STOCK SHIFTER CR125	97-02	C189BE	\$63.61	EC083032AFM	Inner Clutch Cover Gasket	\$6.98	11394-KZ4-A90
				EC185020F	Center Case Gasket	\$16.78	11191-KZ4-620
				EC228	Clutch Cover Gasket	\$11.81	91311-KS6-700
				EC510060AFM	Magneto Cover Gasket	\$6.50	11352-KS6-700
				IR003018AFM	Intake Gasket	\$3.95	14132-KY4-970
				WP033018AFM	Water Pump Gasket	\$5.14	19229-KZ-620
				R16X3V	Fill Plus O-Ring	\$1.31	91303-800-000
				R20X2V	Output Shaft O-Ring	\$3.14	94109-12000
				WA133	Water Pump Drain Plug Gasket	\$0.94	90543-273-000
				WA117	Drain Plug Gasket	\$0.99	94109-12000

IAME

Model	Year	Bore Size	Top End Kit #	List Price	Component #	Component Description	List Price	OEM Part #
MINI SWIFT	All	41.8mm	C193	\$22.47	H4377005C	Head Gasket .005"	\$6.50	A-61049
					B1358015F	Base Gasket	\$6.50	EBP-85045
					IR1380020F	Intake Gasket	\$2.91	A-61822
					EX1684059F	Exhaust Gasket	\$4.32	A-61360
					WA146	Copper Washer	\$2.25	
LEOPARD	08-Later	54mm	C194	\$42.07	R143V	Inner Head O-Ring	\$8.68	DBP-95049
					R249B	Outer Head O-Ring	\$5.28	B-25820
					R8X1.5V	Stud O-Ring (4 Req.)	\$2.44	B-25825
					B1354015F	Base Gasket	\$6.50	BP-25045
					IR1370032AFM	Intake Manifold Gasket	\$3.59	11810
					IR1371031F	Intake Reed Block Gasket	\$2.91	11805-A
					CB456039F	Carburetor Gasket	\$1.25	10360-A
					EX1674059F	Exhaust Gasket	\$4.32	B-85360
					WA082063C	Temp Sensor Washer	\$2.01	B-25845

LEOPARD MY09	All	54mm	C195	\$41.39	R143V	Inner Head O-Ring	\$8.68	DBP-95049
					R249B	Outer Head O-Ring	\$5.28	B-25820
					R8X1.5V	Stud O-Ring (4 Req.)	\$2.44	B-25825
					B1213015F	Base Gasket	\$6.50	EBP-125045
					IR1368031F	Intake Manifold Gasket	\$2.91	F-11810
					IR1369031F	Intake Reed Block Gasket	\$2.91	F-11805
					CB456039F	Carburetor Gasket	\$1.25	10360-A
					EX1674059F	Exhaust Gasket	\$4.32	B-85360
					WA082063C	Temp Sensor Washer	\$2.01	B-25845

X30	All	54mm	C196	\$49.63	B1213015F	Base Gasket .015"	\$6.50	EBP-125045
					CB456039F	Carburetor Gasket	\$1.25	10360-A
					EX1673059F	Exhaust Gasket	\$4.32	B-75360
					IR1368032AFM	Intake Reed Block Gasket	\$2.91	X30125810
					IR1369031F	Intake Manifold Gasket	\$2.91	F-11805
					R246B	Outer Head O-Ring	\$5.28	F-38820
					R59X2.5V	Inner Head O-Ring	\$4.64	D-37049
					R8X1.5V	Stud O-Ring (4 Req.)	\$2.44	B-25825
					WA213043C	Temp Sensor Washer	\$1.46	B-25845
					WA214050C	Water Pipe Washer	\$1.72	B-25835

X30	All	Bottom End Kit # C196BE	\$16.61	EC2206032AFM	Magneto Cover Gasket	\$6.76	X30125878
				OS359	Crank Seal (2 Req.)	\$3.98	X30125425A
				R329B	Magneto Dampener O-Ring	\$1.88	X30125853

PRD

Model	Year	Bore Size	Top End Kit #	List Price	Component #	Component Description	List Price	OEM Part #
PRD FIREBALL	All	54mm	C197	\$31.39	R143V	Inner Head O-Ring	\$8.68	9012555
					R249B	Outer Head O-Ring	\$5.28	9011555
					R015V	Stud O-Ring (4 Req.)	\$1.21	9024555
					B1355012F	Base Gasket	\$3.69	9057555A
					IR1374020F	Intake Manifold Gasket	\$2.24	9101555
					IR1375020F	Intake Reed Block Gasket	\$2.24	9100555
					CB457020F	Carburetor Gasket	\$0.86	9107555
					EX1675064AM	Exhaust Gasket	\$3.69	9021555

ROTAX

Model	Year	Bore Size	Top End Kit #	List Price	Component #	Component Description	List Price	OEM Part #
FR125 MAX EVO	All	54mm	C198	\$38.08	R037V	Inner Head O-Ring	\$11.79	250 160
					R155B	Outer Head O-Ring	\$1.21	250 280
					R118B	Spark Plug O-Ring	\$1.21	430 782
					B1356012F	Base Gasket .012"	\$4.06	650 480
					B1356015F	Base Gasket .015"	\$4.06	650 481
					B1356020F	Base Gasket .020"	\$4.35	650 482
					B1356031F	Base Gasket .031"	\$4.35	650 483
					IR1377031F	Intake Manifold Gasket	\$2.37	250 521
					EX1677059F	Exhaust Gasket	\$3.90	250 271
					PV154031F	Power Valve Gasket	\$0.86	250 231



Karting Gaskets

YAMAHA

Model	Year	Bore Size	Top End Kit #	List Price	Component #	Component Description	List Price	OEM Part #	
KT100	All	54mm	C134	\$25.36	H0524032C	Head Gasket	\$6.44		
					B0308015F	Base Gasket	\$2.81		
					CB030020F	Intake Carb Spacer (2 Req.)	\$1.40		
					CB031031F	Intake Manifold to Carb Gasket	\$1.67		
					EX131	Exhaust Gasket	\$7.13		
					IR097020F	Intake Gasket	\$1.08		
					EC181012F	Center Case Gasket	\$4.49		

• Suggested Oil: Klotz KL-104

YF200R1	All	71mm	C184	\$55.75	H1795036S	Head Gasket Multi-Layer Steel	\$11.63	F21-304-30
					IR369018AFM	Intake Gasket	\$4.78	F21-310-00
					EX476042AM	Exhaust Gasket	\$4.78	F21-309-00
					EC758018AFM	Tillostson Flange Gasket	\$4.96	F21-318-00
					EC759020RC	Side Cover Gasket	\$12.89	F21-317-00
					VC076060AFM	Valve Cover Gasket	\$8.38	F21-314-00
					VC077032AFM	Valve Cover Baffle	\$8.33	F21-315-00

• Suggested Oil: Klotz KL-870



Karting Gasket Illustrations

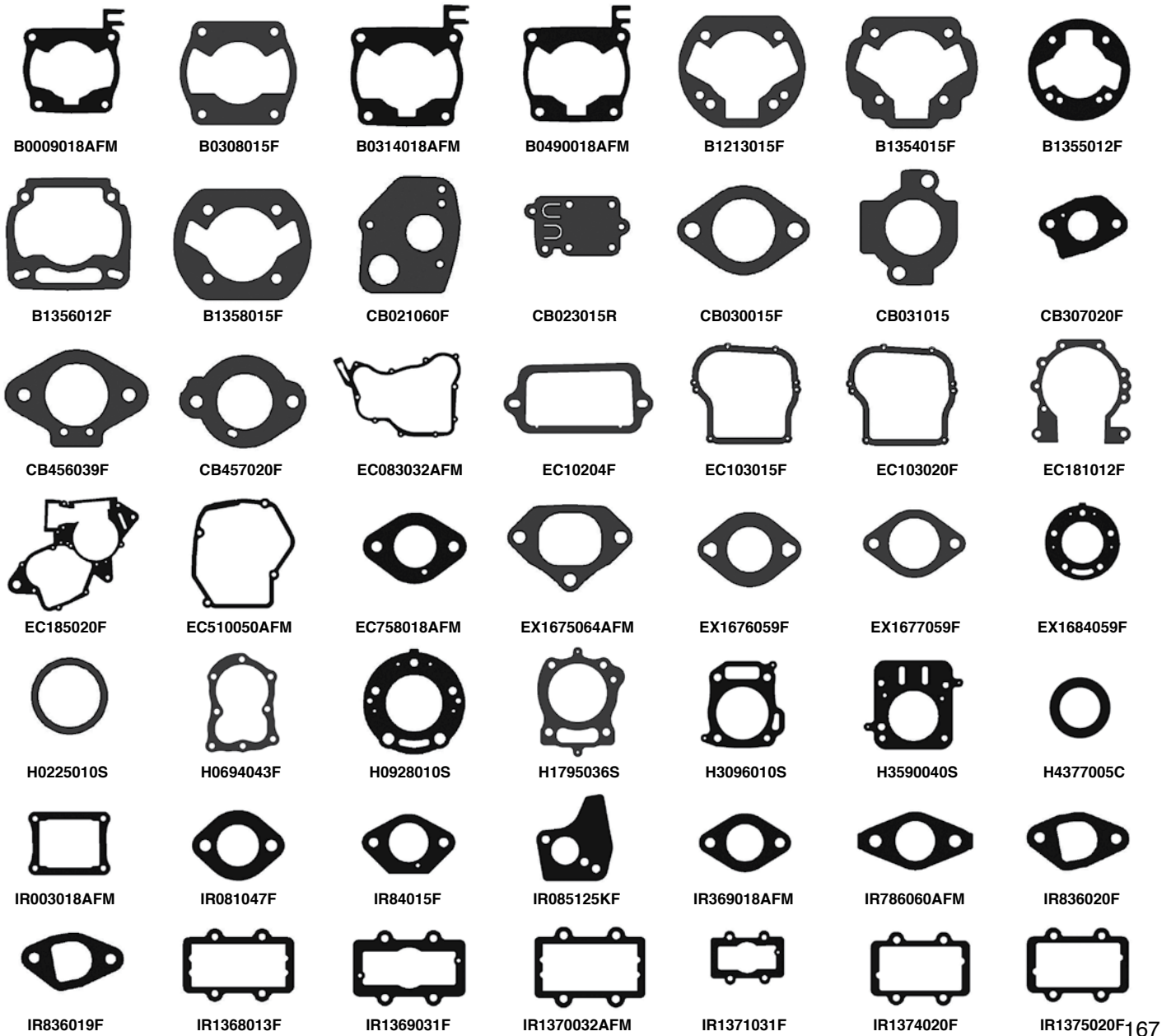



Karting Gasket Illustrations

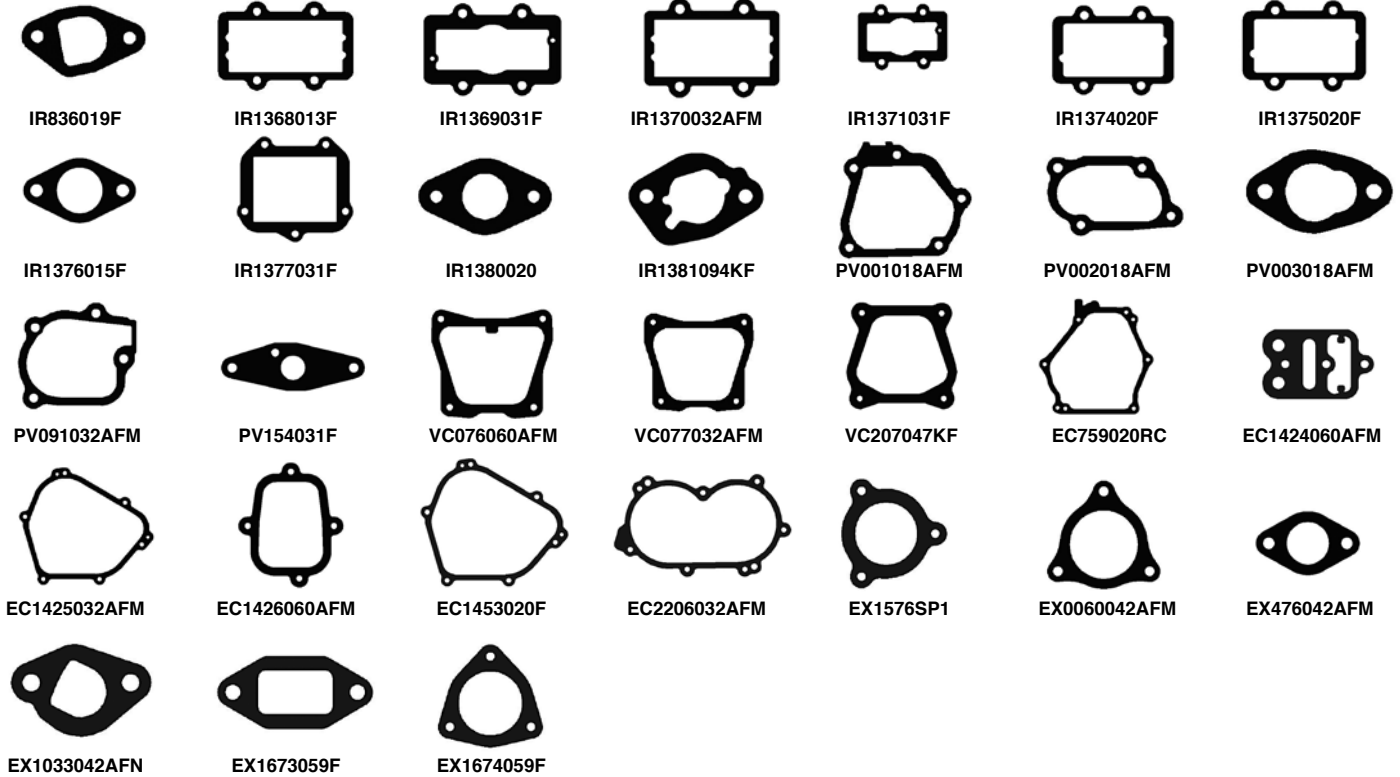

UTV Gaskets

ARCTIC CAT UTV PROWLER 550 XT

Model	Year	Bore Size	Top End Kit	List Price	Component Part#	Component Description	List Price	OEM Part #
Prowler 550 XT	09-15	94mm	C3741	\$65.51	H1962027S	Head Gasket	\$30.15	0830-097
					B0647014RC	Base Gasket	\$6.44	0830-084
					R22X2.5V	Water Outlet O-ring	\$2.30	0830-007
					3186V	Valve Stem Seal	\$5.19	0830-186
					R54X2V	Tappet Cover O-ring	\$4.31	0830-004
					EX657	Header Gasket	\$9.74	0412-338
					EC377032AFM	Cam Chain Tensioner gasket	\$3.48	0810-072
					R45X3V	Intake O-ring	\$2.82	0830-090

PROWLER 650

Model	Year	Bore Size	Top End Kit	List Price	Component Part#	Component Description	List Price	OEM Part #
Prowler 650	06-09	98 mm	C7220	\$68.57	H1735SP3027S	Head Gasket 98mm Bore	\$37.15	0830-124
		100 mm	C7022	\$68.57	H1735SP4027S	Head Gasket 100mm Bore	\$37.15	0830-124
					B0647014RC	Base Gasket	\$6.44	0830-084
					EX657	Exhaust Gasket	\$9.74	0412-338
					EC377032AFM	Cam Chain Tens. Gasket	\$3.48	0830-018
					OS020	2 Req.-Cam Chain Tens. O-ring	\$1.07	0830-107
					R22X2.5V	Coolant Line O-ring	\$2.30	0830-007
					R45X3V	Intake O-ring	\$2.82	0830-090
					R54X2V	2 Req.-Valve Cover O-rings	\$4.31	0830-004
					3186V	Valve Stem Seal	\$5.19	0830-186

Bottom End Gaskets Available Separately

Component Part#	Component Description	List Price	OEM Part #
EC1142032AFM	Clutch Cover Gasket	\$32.19	0830-116
EC1143032AFM	Magneto Cover Gasket	\$25.98	0830-128
EC1141032AFM	Primary Cover Gasket	\$37.15	0830-174



UTV Gaskets

ARCTIC CAT UTV PROWLER 700XT LTD

Model	Year	Bore Size	Top End Kit	List Price	Component Part#	Component Description	List Price	OEM Part #
Prowler	08-17	103.5mm	C3597-EST	\$68.57	H2223SP4027S	Head Gasket	\$27.58	0830-112
700 XT LTD					B0760014RC	Base Gasket	\$5.76	0830-111
HDX700	11-17				EX657	Exhaust Gasket	\$6.44	0412-338
					OS020	Cam Chain Tensioner Gasket	\$1.07	0830-107
					EC377032AFM	Cam Chain Tens. Gasket	\$3.48	0830-018
					3186V	Valve Seals	\$5.19	0830-186
					R22X2.5V	Water Outlet O-ring	\$2.30	0830-007
					R124V	Valve Cover O-rings 2 req.	\$1.24	0830-215
					R008B	Intake O-ring	\$0.11	0423-182
					R124V	Oil Fill Cap O-ring	\$1.24	0830-215
					R54X2V	Inspection Cap O-ring	\$4.31	0830-004

Bottom End Gaskets Available Separately

Component Part#	Component Description	List Price	OEM Part #
EC1142032AFM	Clutch Cover Gasket	\$32.19	0830-116
EC1143032AFM	Magneto Cover Gasket	\$25.98	0830-128
EC1141032AFM	Primary Cover Gasket	\$37.15	0830-174

PROWLER/WILDCAT 1000

Model	Year	Bore Size	Top End Kit	List Price	Component Part#	Component Description	List Price	OEM Part #
Prowler	11-17	93.5mm	C3568-EST	\$131.64	H2399SP6027S	Head Gasket	\$31.80	0830-209
Wildcat 1000					B1155014RC	Base Gasket	\$20.39	0830-193
					EX657	Exhaust Gasket	\$9.74	0412-338
					EC2035032AFM	Cam Chain Tensioner Gasket 2 Req.	\$3.48	0830-134
					3186V	Valve Seals 8 Req.	\$5.19	0830-186
					R118V	Water Outlet O-ring	\$1.18	0830-007
					OS384	Water Inlet Seal	\$5.28	0830-120
					R54X2V	Valve Cover O-rings 4 req.	\$4.31	0830-004
					R45X3V	Intake O-ring 2 req.	\$2.82	0830-090

CAN-AM/BOMBARDIER UTV COMMANDER 1000

Model	Year	Bore Size	Top End Kit	List Price	Component Part#	Component Description	List Price	OEM Part #
Commander	11-20	92mm	C3459-EST	\$161.20	H2653018S	Head Gasket 92mm 2 Req.	\$46.33	420630195
1000		93mm	C3460-EST	\$161.20	H2653SP1018S	Head Gasket 93mm 2 Req.	\$46.33	
Maverick	13-20	94mm	C3461-EST	\$161.20	H2653SP2018S	Head Gasket 94mm 2 Req.	\$46.33	
		96mm	C3462-EST	\$161.20	H2653SP5018S	Head Gasket 95mm 2 Req.	\$46.33	
					3186V	Valve Stem Seal 8 Req.	\$5.19	420230515
					R117V	Cam Chain Tensioner O-ring	\$1.24	420430370
					R15X1.5V	Cam Adjuster O-ring	\$1.18	420250890
					EX696	Header Gasket 2 Req.	\$10.69	707600317
					B0895010RC	Base Gasket 2 Req.	\$15.85	420630210

Bottom End Gaskets Available Separately

Component Part#	Component Description	List Price	OEM Part #
EC1652020F	Center Case Gasket	\$29.47	420651225
EC1651020F	PTO Cover Gasket	\$14.55	420651211
EC1171032AFM	Magneto Cover Gasket	\$17.66	420651200

HONDA UTV FL250 ODYSSEY

Model	Year	Bore Size	Top End Kit	List Price	Component Part#	Component Description	List Price	OEM Part #
FL250	77-84	72 mm	C7140	\$26.57	H0182043F	Head Gasket 72mm	\$20.05	12251-358-306
Odyssey					B0137020F	Base Gasket 73-76	\$6.50	12191-357-306
					B0395020F	Base Gasket 77-84	\$5.55	12191-381-306

FL350R ODYSSEY

Model	Year	Bore Size	Top End Kit	List Price	Component Part#	Component Description	List Price	OEM Part #
FL350R	85	82 mm	C7229	\$33.19	H0344043F	Head Gasket	\$23.21	12254-VM0-013
					B0204020F	Base Gasket	\$7.45	12191-VM0-772

Pilot FL-400

Model	Year	Bore Size	Top End Kit	List Price	Component Part#	Component Description	List Price	OEM Part #
Pilot FL-400	89-90	82 mm	C7024	\$37.15	H0015043F	Head Gasket	\$23.21	12251-HE0-000
					B0020020F	Base Gasket	\$6.50	12191-HE0-000
					EX009042AM	Exhaust Gasket	\$4.84	18291-HE0-000
					IR004018AFM	Intake Gasket	\$3.95	14132-430-000



WARNING: Cancer and Reproductive Harm www.P65Warnings.ca.gov



UTV Gaskets

HONDA UTV

MUV700 BIG RED/SXS700M PIONEER

Model	Year	Bore Size	Top End Kit	List Price	Component Part#	Component Description	List Price	OEM Part #
MUV700	09-14	105mm	C3475-EST	\$71.46	VC080020RC	Valve Cover Gasket	\$24.75	12315-HN8-000
Big Red					R57X2V	Tappet Cover O-Ring	\$3.33	91308-500-000
SXS700M	2014				H1835027S	Cylinder Head Gasket	\$40.93	12251-HN8-A61
Pioneer					B0665010S	Cylinder Base Gasket	\$15.90	12191-HN8-000
					EX651	Exhaust Gasket	\$9.34	18291-MM5-860
					3231V	Valve Stem Seal	\$6.74	12209-KL4-005
					EC036018AFM	Cam Chain Tensioner	\$2.04	12194-HC5-740
					R9.5X1.5V	Rocker Arm O-Rings	\$2.56	91306-MG3-000

TALON 1000 SXS1000

Model	Year	Bore Size	Top End Kit	List Price	Component Part#	Component Description	List Price	OEM Part #
Talon 1000	19-21	93mm	C3112	\$119.99	EC2550018AFM	Timing Chain Tensioner Gkt.	\$2.99	14523-HL4-003
SXS1000					MA0164	Timing Chain Tensioner	\$0.97	90442-397-000
						Crush Washer		
					3016V	Intake Valve Seal	\$6.74	12208-MEG-003
					3021V	Exhaust Valve Seal	\$6.74	12208-413-003
					WA259	Lash Stopper Bolt O-ring	\$2.60	90544-KF0-000
					H4799023S	Head Gasket	\$53.80	12251-HL6-A01
					EX2108	Header Gasket	\$6.90	18291-MM8-880

KAWASAKI UTV

KRF750 TERYX (SXS)

Model	Year	Bore Size	Top End Kit	List Price	Component Part#	Component Description	List Price	OEM Part #
KRF750	08-13	85mm	C3284-EST	\$127.50	H2624SPA010S	Cylinder Head Gasket 85mm	\$29.42	11004-0011
Teryx (SXS)		90 mm	C3251-EST	\$127.50	H2624SP1010S	Cylinder Head Gasket 90mm	\$29.42	11004-0011
					B0951020RC	Base Gasket	\$10.34	11061-0063
					EX361	Exhaust Gasket 2 req	\$5.72	11009-1894
					WA114	Coolant Drain Washer 2 Req	\$3.14	
					R55X2V	Rocker Cap O-Ring 4 Req	\$2.43	92055-0112
								671D2555
					R19X2V	Plug Cover O-Ring 2 Req	\$2.60	92055-1146
					3242V	Valve Stem Seals 8 Req	\$3.02	92049-1218

KRX1000/KRF1000 TERYX

Model	Year	Bore Size	Top End Kit	List Price	Component Part#	Component Description	List Price	OEM Part #
KRX1000	20	92mm	C3110	\$124.79	H4879024HP	Cyl. Head Gasket Stock 92mm	\$53.80	11004-0785
KRF1000		95mm	C3111	\$124.79	H4879SP2024HP	Cylinder Head Gasket 95mm	\$53.80	
					R49.5x2B	Intake O-rings	\$6.99	R49.5x2B
					EC2753032AFM	Breather Plate Gasket	\$11.52	11061-1314
					B1504010RC	Cylinder Base Gasket	\$22.10	11061-1309
					R018B	Cam Chain Tensioner O-ring	\$4.08	92055-086
					R9X2V	Cam Chain Guide O-ring	\$1.65	670D1509
					3241V	Valve Stem Seal	\$3.43	92049-1062
					EX2248030S	Exhaust Manifold Gasket	\$10.35	11061-1310

POLARIS UTV

RZR170

Model	Year	Bore Size	Top End Kit	List Price	Component Part#	Component Description	List Price	OEM Part #
RZR 170	09-21	61mm	C3596-EST	\$51.83	B1318020RC	Cylinder Base Gasket	\$2.26	0455362
					H4194010S	Cylinder Head Gasket	\$20.79	0455363
					IR1308020F	Intake Manifold Gasket	\$3.07	0455364
					R024V	Intake Manifold O-Ring	\$1.24	0452459
					R049B	Cylinder Head Cover O-Ring	\$3.09	0455365
					EC2131032AFM	Cylinder Head Breather Gasket	\$4.98	0455382
					EC2132060AFM	Air Injection Gasket 09-14	\$2.49	0455377
					EC2133060AFM	Air Injection Tube Gkt. 09-14	\$2.49	0455390
					EX886042AM	Exhaust Gasket	\$4.47	0455340
					3234V	Valve Stem Seal	\$5.72	0452390
					EC2134032AFM	Cam Chain Tensioner Gasket	\$1.29	0455357

RZR 570

Model	Year	Bore Size	Top End Kit	List Price	Component Part#	Component Description	List Price	OEM Part #
RZR 570	12-20	99mm	C3528-EST	\$82.18	B1171014RC	Base Gasket	\$20.06	5260934 5262008
RZR Trail					H3609021S	Head Gasket 99mm Bore	\$35.64	5813676 5814089
					3231V	Valve Seals 4 Req. 2012	6.74	3610161
					3254V	Valve Spring Seat With Seal 2013+	\$5.42	3610212
					EX817	Exhaust Gasket	\$11.73	5253989
					EC1654020RC	Cam Chain Tensioner	\$3.66	5813449



UTV Gaskets

POLARIS UTV

RANGER RZR 800 (SXS)

Model	Year	Bore Size	Top End Kit	List Price	Component Part#	Component Description	List Price	OEM Part #
Ranger RZR 800 (SXS)	08-10	80 mm	C3250	\$73.80	H2761030S	Head Gasket 80mm Bore	\$53.80	5247359
RZR S	09-10	82 mm	C3507	\$73.80	H2761SP2030S	Head Gasket 82mm Bore	\$53.80	
					B0940010RC	Base Gasket	\$12.06	5247360
					EX452SP1064AM	Exhaust Gasket	\$16.13	5811511

RANGER RZR 800 (SXS)

Model	Year	Bore Size	Top End Kit	List Price	Component Part#	Component Description	List Price	OEM Part #
Ranger RZR 800 (SXS)	11-17	80 mm	C3506	\$73.80	H3657010S	Head Gasket 80mm Bore	\$35.64	5254357
		82 mm	C3508	\$73.80	H3657SP2010S	Head Gasket 82mm Bore	\$35.64	
					B0940010RC	Base Gasket	\$12.06	5247360
					EX452SP1064AM	Exhaust Gasket	\$16.13	5811511

XP900

Model	Year	Bore Size	Top End Kit	List Price	Component Part#	Component Description	List Price	OEM Part #
XP900	11-13	93.5mm	C3446-EST	\$89.09	H3336018S	Head Gasket 93.5mm Bore	\$35.64	5813439
RZR 4 900	14	96mm	C3447-EST	\$89.09	H3336SP1018S	Head Gasket 96mm Bore	\$35.64	
RZR 4 XP900	12-13				B1079014RC	Base Gasket	\$20.06	5253037
					EC1654020RC	Cam Chain Tensioner	\$3.66	5813449
					WP383032AFM	Water Inlet Gasket	\$3.89	5813521
					EX817	Exhaust Gasket 2 req.	\$11.73	5253989
					3231V	Valve Seals 11-12 8 Req.	\$6.74	3610161
					3254V	Valve Spring Seat	\$5.42	3610212
						With Seal 13-14		

RZR XP1000

Model	Year	Bore Size	Top End Kit	List Price	Component Part#	Component Description	List Price	OEM Part #
RZR XP 1000	14-19	94mm	C3546-EST	\$89.09	H3892018S	Head Gasket 94mm Bore	\$35.64	5813737
RZR XP 4 1000	14-19	96mm	C3563-EST	\$89.09	H3892SP1018S	Head Gasket 96mm Bore	\$35.64	5813737
900 ACE	16-19				B1079014RC	Base Gasket	\$20.06	5253037
General 1000	16-19				EC1654020RC	Cam Chain Tensioner Gkt.	\$3.66	5813449
Ranger 1000	18-19				EC2668031F	Cam Chain Tensioner Gkt. (2017-2020)	\$3.66	5814561
RZR 1000	16-19				EX1408064AM	Header Gasket	\$12.69	3610184
RZR XP Turbo	16				3254V	Valve Spring Seat w/Seal	\$5.42	3610212
					MR135	Thermostat Seal	\$4.16	5413948
					MR136	Water Outlet O-Ring	\$11.43	5813736

RZR XP TURBO

Model	Year	Bore Size	Top End Kit	List Price	Component Part#	Component Description	List Price	OEM Part #
RZR XP Turbo	17-21	95mm	C3039	\$135.19	B1079014RC	Base Gasket	\$20.06	5253037
RZR XP Turbo Tractor	18				EX1408064AM	Header/Turbo Manifold Gkt	\$12.69	3610184
RZR XP4 Turbo	17-21				H4669036S	MLX Cylinder Head Gkt	\$54.53	5814693
RZR Turbo 4	19				WA140	Head Oil Drain Crush Washer	\$0.66	7555998
RZR XP4 Turbo S	19				3254V	Valve Spring Seat w/Seal	\$5.42	3610212
RZR Turbo S 4	20-21				EC2668031F	Cam Chain Tensioner Gkt. (2017-2020)	\$3.66	5814561
RZR Turbo S	20-21				MR136	Water Outlet O-Ring	\$11.43	5813736
RZR XP Turbo S	18-19				EX1307	Downpipe Gasket	\$11.23	5812640

YAMAHA UTV

RHINO 450

Model	Year	Bore Size	Top End Kit	List Price	Component Part#	Component Description	List Price	OEM Part #
Rhino 450	06-09	85.5mm	C3213-EST	\$67.25	H2464027S	Head Gasket	\$37.15	5GH-11181-00-00
					EC998032AFM	Cam Chain Tensioner	\$2.42	3GD-12213-00-00
					EX130	Exhaust Gasket	\$8.10	3GD-14613-00-00
					B0918031F	Cylinder Base Gasket	\$12.34	5GH-11351-00-00
					R89X2.5V	Cylinder Sleeve O-ring	\$4.61	93210-89447-00
					R116V	Cylinder Dowel O-ring	\$1.18	93210-18322-00
					WA118	Cylinder Drain Crush Washer	\$1.96	90430-06014-00
					R106X2V	Breather Plate O-ring	\$5.94	93211-06635-00
					R141V	Tappet Cover O-ring	\$6.49	93210-57634-00
					R012B	Rocker Shaft O-ring	\$0.53	93210-09350-00
					3230V	Valve Seal	\$6.42	M01-12129-00-00
					R031B	Intake O-ring	\$4.84	93210-44545-00
					WP077031F	Thermostat Gasket	\$2.78	2P5-12434-00-00





UTV Gaskets

YAMAHA UTV RHINO 660 (SXS)

Model	Year	Bore Size	Top End Kit	List Price	Component Part#	Component Description	List Price	OEM Part #
RHINO 660 (SXS)	04-07	101 mm	C3791	\$92.56	H1481030S	Head Gasket 101mm	\$28.35	3YF-11181-00-00
		102 mm	C3792	\$92.56	H1191030S	Head Gasket 102mm	\$28.35	
		103 mm	C3793	\$92.56	H2174030S	Head Gasket 103mm	\$28.35	
		105 mm	C3795	\$92.56	H1191SP1030S	Head Gasket 105mm	\$28.35	
					B1532008S	Base Gasket	\$9.85	5KM-11351-00-00
					EX361	Exhaust Gasket 2 Req.	\$5.72	3YF-14613-01-00
					EC584018AFM	Cam Chain Tensioner Gasket	\$3.72	4DW-12213-00-00
					3187V	Valve Seal 5 Req.	\$3.14	5H0-12119-00-00
					R016B	Radiator Hose O-Ring	\$0.77	93210-18417-00
					R113B	Valve Cover Plug O-Ring	\$1.24	93210-13657-00
					R114S	Oil Tank O-Ring	\$4.08	93210-16629-00
					R116B	Cam Chain Tensioner	\$1.18	93210-19522-00
						Cap O-Ring		
					R117B	Dipstick O-Ring	\$0.44	93210-21190-00
					R124B	Tappet Cover O-Ring	\$4.08	93210-32172-00
					R155S	Cylinder Base O-Ring	\$4.08	93211-01467-00
					R71X2.5B	Int. Valve Adj. Cover O-Ring	\$2.67	93210-71360-00
					WA081080C	Oil Line Washers 4 Req.	\$0.59	90430-08204-00
					WA082063C	Oil line Washers 4 Req.	\$2.01	90430-10171-00

RHINO 700 VIKING

Model	Year	Bore Size	Top End Kit	List Price	Component Part#	Component Description	List Price	OEM Part #
Rhino 700	08-13	103 mm	C3142-EST	\$93.02	H2449027S	Head Gasket	\$42.17	3B4-11181-00-00
Viking	14-21	104 mm	C3143-EST	\$93.02	H2449SP2027S	Head Gasket 104mm Bore	\$42.17	3B4-11181-00-00
		105.5 mm	C3144-EST	\$93.02	H2465027S	Head Gasket 105.5mm Bore	\$42.17	3B4-11181-00-00
					B0855010RC	Base Gasket	\$9.85	1S3-11351-00-00
					EX361	Exhaust Gasket 2 Req.	\$5.72	3YF-14613-01-00
					R034V	Throttle Body O-Ring	\$3.12	4WV-14147-10-00
					R126V	Water Pump O-Ring	\$1.24	93210-33006-00
					R131B	Thermostat O-Ring	\$1.18	93210-41042-00
					R240V	Cam Cover O-Ring	\$4.08	93210-96601-00
					R79X2.5V	Valve Cover O-Rings 2 Req.	\$7.58	93210-78544-00
					3187V	Valve Seal 4 Req.	\$3.14	5H0-12119-00-00
					EC584018AFM	Cam Chain Tensioner Gasket	\$3.72	4DW-12213-00-00

WOLVERINE R-SPEC YXE700

Model	Year	Bore Size	Top End Kit	List Price	Component Part#	Component Description	List Price	OEM Part #
Wolverine R-Spec YXE700	16-18	103mm	C3599-EST	\$67.16	EC2098032AFM	Cam Chain Tensioner Gasket	\$2.56	2MB-E2213-00-00
					WA003032C	Cam Chain Tensioner Crush Gasket	\$0.73	2MB-E21E2-00-00
					B1306010RC	Cylinder Base Gasket	\$9.85	2MB-E1351-00-00
					H4173023S	103mm Bore Cylinder Head Gasket	\$42.17	2MB-E1181-00-00
					VC362018AFM	Valve Cover Breather Gasket	\$4.18	2MB-E131B-00-00
					EX045	Header Gasket	\$4.43	3EG-14613-00-00
					WA117	Oil Line Banjo Bolt Crush Gaskets	\$0.99	2MB-E1195-00-00
					3187V	Exhaust Valve Seal	\$3.14	2MB-E2129-00-00
					R125V	Water Outlet O-Ring	\$1.24	2MB-E2843-00-00

YXZ1000R

Model	Year	Bore Size	Top End Kit	List Price	Component Part#	Component Description	List Price	OEM Part #
YXZ1000R	16-21	82.5mm	C3617	\$104.57	R116B	Fill Plug O-Ring	\$1.18	93210-19123-00
					WA116	Cylinder Head Drain Plug Crush Washer	\$1.10	90430-08119-00
					H4270016S	Cylinder Head Gasket	65.14	2HC-11181-00-00
					EX651	Exhaust Gasket 3 Req	9.34	4FM-14613-00-00
					3241V	Valve Stem Seal 12 Req.	1.53	2HC-12119-00-00



Klotz Synthetic Lubricants are designed and engineered to be the best lubricants in the motorsports industry. Race tested and formulated for all engine types, Klotz offers a full line of Estorlin Synthetic Racing Oils, Power Additives, and Aerosols needed to keep your engine protected and performing at an optimal level.

Racers, engine builders, and performance enthusiasts around the world rely on Klotz to get them to the checkered flag. Be Fast, Be First with Klotz Synthetic Lubricants.

For more information, Tech Sheets, or MSDS Sheets please visit www.klotzlube.com

ESTORLIN® RACING PERFORMANCE SYNTHETIC ENGINE LUBRICANT



Part#	Description	Price
KE-925	5W/20 Qt.	CALL FOR PRICING
KE-930	10W/30 Qt.	
KE-935	5W/30 Qt.	
KE-940	10W/40 Qt.	
KE-950	20W/50 Qt.	
KE-954	15W/40 Qt.	
KE-955	15W/50 Qt.	
KE-915	15W/55 Qt.	

Also available by the Case & 5 Gallon Pail



UPLON® FUEL LUBE

- Provides upper cylinder and fuel pump lubrication
- Blends with methanol alcohol, ethanol, nitromethane and gasoline
- Maintains constant fuel pressure

Part#	Description	Price
KL-106	Pint	CALL FOR PRICING
KL-107	Quart	

Also available by the Case

ESTORLIN® FREE-GEAR® HYPOID SYNTHETIC GEAR LUBRICANT

Part#	Description	Price
KE-960	75W/75 Qt.	CALL FOR PRICING
KE-970	75W/80 Qt.	

Also available by the Case & 5 Gallon Pail



ESTORLIN® FREE-GEAR® MANUAL TRANSMISSION SYNTHETIC GEAR LUBRICANT

Part#	Description	Price
KE-965	75W/75 Qt.	CALL FOR PRICING
KE-975	75W/80 Qt.	
KE-980	75W/90 Qt.	
KE-990	80W/90 Qt.	
KE-994	75W/140 Qt.	
KE-995	75W/110 Qt.	

Also available by the Case & 5 Gallon Pail



Additives & Aerosols

Assembly Lube
Fogon - Storage & Afterrun Lubricant

Foam Air Filter Oil
Fabric Air Filter Oil
Air Filter Cleaner
Plug & Contact Cleaner
Ethanol Gasoline Faze separation Treatment
Storbilizer
Cometic Engine Block & Head Surface Cleaner

Part#	Description	Price
KL-311	12oz.	CALL FOR PRICING
KL-612	6oz.	
KL-610	16oz.	
KL-606	15.25oz	
KL-607	15.25	
KL-608	15.25oz	
KL-609	12.5oz	
KL-603	16oz.	
KL-613	16oz.	
C1047	15.25oz	





2-STROKE LUBRICANTS Available Individually, Case, 30 gal. & 55 gal. drum



4-STROKE LUBRICANTS Available Individually, Case, 30 gal. & 55 gal. drum



SUPER TECHNIPLATE®

Part#	Description	Price
KL-103-1	1 Pint Bottle	CALL FOR PRICING
KL-100-1	1 Quart Bottle	CALL FOR PRICING
KL-109-1	1/2 Gallon Bottle	CALL FOR PRICING
KL-101-1	1 Gallon Bottle	CALL FOR PRICING

ORIGINAL TECHNIPLATE®

Part#	Description	Price
KL-200-1	1 Quart Bottle	CALL FOR PRICING
KL-205-1	1 Gallon Bottle	CALL FOR PRICING

BeNOL® RACING CASTOR LUBRICANT

Part#	Description	Price
BC-175-1	1 Pint Bottle	CALL FOR PRICING
BC-172-1	1 Quart Bottle	CALL FOR PRICING
BC-179-1	1/2 Gallon Bottle	CALL FOR PRICING
BC-171-1	1 Gallon Bottle	CALL FOR PRICING

MOTORCYCLE TECHNIPLATE® TC-2

Part#	Description	Price
KL-300-1	1 Quart Bottle	CALL FOR PRICING
KL-301-1	1 Gallon Bottle	CALL FOR PRICING

R-50® RACING TECHNIPLATE®

Part#	Description	Price
KL-102-1	1 Pint Bottle	CALL FOR PRICING
KL-104-1	1 Quart Bottle	CALL FOR PRICING
KL-105-1	1 Gallon Bottle	CALL FOR PRICING

MOTORCYCLE TECHNIPLATE® TC-W3

Part#	Description	Price
KL-302-1	1 Quart Bottle	CALL FOR PRICING

50:1 TECHNIPLATE® TC-W3

Part#	Description	Price
KL-305-1	1 Pint Bottle	CALL FOR PRICING
KL-304-1	1 Quart Bottle	CALL FOR PRICING

SKICRAFT® TECHNIPLATE®

Part#	Description	Price
KL-306-1	1 Quart Bottle	CALL FOR PRICING
KL-307-1	1 Gallon Bottle	CALL FOR PRICING

RACING SYNTHETIC FORK & SHOCK FLUID

Part#	Description	Price
KL-505-1	1 Quart Bottle 5W	CALL FOR PRICING
KL-515-1	1 Quart Bottle 10W	CALL FOR PRICING
KL-515-1	1 Quart Bottle 15W	CALL FOR PRICING

ATV/UTV SYNTHETIC ENGINE LUBRICANT

Part#	Description	Price
ATVUTV-040-1	0W/40 1 Qt. Bottle	CALL FOR PRICING
ATVUTV-550-1	5W/50 1 Qt. Bottle	CALL FOR PRICING

ATV/UTV SYNTHETIC ENGINE LUBRICANT WITH INTEGRATED TRANSMISSION

Part#	Description	Price
ATVUTV-1040-1	10W/40 1 Qt. Bottle	CALL FOR PRICING

MX4® TECHNIPLATE®

Part#	Description	Price
KL-860-1	10W/40 1 Qt. Bottle	CALL FOR PRICING
KL-870-1	10W/30 1 Qt. Bottle	CALL FOR PRICING
KL-880-1	15W/50 1 Qt. Bottle	CALL FOR PRICING

MOTORCYCLE TECHNIPLATE® WITH INTEGRATED TRANSMISSION

Part#	Description	Price
KL-815-1	15W/50 1 Qt. Bottle	CALL FOR PRICING
KL-830-1	10W/30 1 Qt. Bottle	CALL FOR PRICING
KL-840-1	10W/40 1 Qt. Bottle	CALL FOR PRICING
KL-850-1	20W/50 1 Qt. Bottle	CALL FOR PRICING

SIDE X SIDE SYNTHETIC ENGINE LUBRICANT

Part#	Description	Price
KL-802	5W/50 1 Qt. Bottle	CALL FOR PRICING
KL-805	10W/50 1 Qt. Bottle	CALL FOR PRICING
KL-803	10W/30 1 Qt. Bottle	CALL FOR PRICING
KL-806	15W/50 1 Qt. Bottle	CALL FOR PRICING

PURE ESTORLIN® MARINE

Part#	Description	Price
KE-330	10W/30 1 Qt. Bottle	CALL FOR PRICING
KE-331	10W/30 1 Gallon Bottle	CALL FOR PRICING
KE-340	25W/40 1 Qt. Bottle	CALL FOR PRICING
KE-341	25W/30 1 Gallon Bottle	CALL FOR PRICING
KE-334	10W/40 1 Qt. Bottle	CALL FOR PRICING
KE-335	10W/30 1 Gallon Bottle	CALL FOR PRICING

PURE ESTORLIN® KART LUBRICANT

Part#	Description	Price
KE-220-1	1 Quart Bottle 0W/20	CALL FOR PRICING
KE-230-1	1 Quart Bottle 0W/30	CALL FOR PRICING
KE-240-1	1 Quart Bottle 0W/40	CALL FOR PRICING
KE-225-1	1 Quart Bottle 5W/20	CALL FOR PRICING



V-TWIN LUBRICANTS

TRANSMISSION GEAR LUBE

Part#	Description	Price
KH-GL90-1	80W/90 1 Qt. Bottle	CALL FOR PRICING
KH-GL140-1	75W/140 1 Qt. Bottle	CALL FOR PRICING

GEAR AND CHAIN CASE LUBRICANT

Part#	Description	Price
KH-S80-1	1 Qt. Bottle	CALL FOR PRICING

PRIMARY CASE LUBRICANT

Part#	Description	Price
KH-C80-1	1 Qt. Bottle	CALL FOR PRICING



MULTI-VISCOSITY SYNTHETIC ENGINE LUBRICANT

- Recommended for the Harley Davidson Pre-Evolution, Evolution and Twin Cam
- Certified warranty compliant
- Custom formulated for the V-Twin air-cooled engines
- Reduces engine temperature and detonation
- High temperature film strength improving anti-wear protection

Part#	Description	Price
KH-1040-1	10W/40 1 Qt. Bottle	CALL FOR PRICING
KH-2050-1	20W/50 1 Qt. Bottle	CALL FOR PRICING
KH-2560-1	25W/60 1 Qt. Bottle	CALL FOR PRICING

MULTI-VISCOSITY SYNTHETIC ENGINE LUBRICANT

- Recommended for the Yamaha, Victory and Indian engines
- Certified warranty compliant
- Custom formulated for the V-Twin air-cooled engines
- Reduces engine temperature and detonation
- High temperature film strength improves anti-wear protection

Part#	Description	Price
KV-2040-1	20W/40 1 Qt. Bottle	CALL FOR PRICING
KV-1560-1	5W/60 1 Qt. Bottle	CALL FOR PRICING

STRAIGHT WEIGHT SYNTHETIC ENGINE LUBRICANT

- Custom formulated for the Harley-Davidson Pre-Evolution engines
- Certified warranty compliant
- Reduces friction for Less Drag-More Power®
- High temperature film strength improving antiwear protection
- Reduces engine temperature and detonation

Part#	Description	Price
KH-50-1	SAE 50 1 Qt. Bottle	CALL FOR PRICING
KH-60-1	SAE 60 1 Qt. Bottle	CALL FOR PRICING
KH-70-1	SAE750 1 Qt. Bottle	CALL FOR PRICING



LUBES

	Part#	Size	Price
ATV/UTV Front/Rear End Differential Lube	ATV/UTV-8090-1	1 qt.	CALL FOR PRICING
Flex Drive® 30 Transmission Lubricant	KL-506-1	1 qt.	CALL FOR PRICING
Chain Case Lube	KL-500-1	12.oz	
Chain Lube Aerosol	KL-605-1	15.25oz	
KLR® Clean Chain Lube	KL-611-1	16oz	
Jet Pump Lube	KL-511-1	4oz.	

COMETIC
GASKET

SEALED UNDER PRESSURE

HIGH PERFORMANCE GASKETS

As a leading worldwide supplier of gaskets and engine sealing solutions for high performance vehicles, we understand pressure.

COMETIC.COM

AUTOMOTIVE // POWERSPORTS // V-TWIN // MARINE #SEALEDBYCOMETIC

Facebook, Twitter, Instagram, YouTube icons

Promotional Items



Part #	Description	Price
DC22.....	Package Decal 5.645" x 1.582"	\$.05
DC10.....	Embroidered Patch 2" x 5"	\$2.00
DC04.....	Trailer Decal 6" x 19"	\$4.00
DC30.....	Decal 2.707" x 9.516"	\$1.00
DC11.....	Banner 3' x 8'	\$10.00
DC17.....	StreetPro Decal 1.625" x 9"	\$.50
DC13.....	Dealer Open House Kit	\$64.47
	(50) DC22, (2) DC04, (2) DC11, (2) DC12, (25) Cycle Catalogs	
DC12.....	Cometic Hat	\$10.00

WARRANTY DISCLAIMER*

Due to the nature of performance applications, the parts in this catalog are sold without any express warranty or any implied warranty of merchantability or fitness for a particular purpose. Cometic Gasket Inc. shall not, under any circumstances, be liable for any special, incidental or consequential damages, including, person, party or property, but not limited to, damage, or loss of property or equipment, loss of profits or revenue, cost of purchased or replacement goods, or claims of customers of the purchase, which may arise and/or result from sale, installation or use of these parts. Installation of these parts could adversely affect the motor manufacturers warranty coverage.

VENUE-The agreed upon venue, in the event of any dispute whatsoever between the parties, whether instituted by either party, including, but not limited to, contract terms, payment terms, delivery, type, defects, sufficiency of product, shall be the Court of Common Pleas, Lake County, Ohio or the Painesville Municipal Court, Lake County, Ohio, depending on the amount in controversy. This agreement shall be governed by and construed under the laws of the State of Ohio.

All prices and terms are subject to change without notice.

Terms Open accounts may be established by well rated firms. A credit application is available upon request. Open accounts are due payable Net 30 days from date of invoice. No statement will be sent. If an account becomes 60 or more days past due, it is subject to being placed on credit hold. No orders will be shipped or new orders accepted until past due balance is paid. If an account becomes 90 or more days past due, it is subject to being placed for collections. All costs of collection are the responsibility of the customer, including attorney fees, court costs, and other expenses of litigation.

Returns- Authorization (RGA) must be obtained in advance on all returns. A packing slip or invoice number must accompany the merchandise. No returns after 30 days from invoice date. All returns are subject to a 25% restocking charge. All custom designed and custom manufactured gaskets are non-returnable. Only catalog parts are returnable.

Review your invoice and notify us immediately of any incorrect or inaccurate information. Shortages must be reported within 10 days.

www.Cometic.com

New shopping experience. Gasket material and technology information.
Partnership stories. Collaborate with Cometic on custom gaskets. Chat room.



You Build It. We Seal It.
#SealedbyCometic

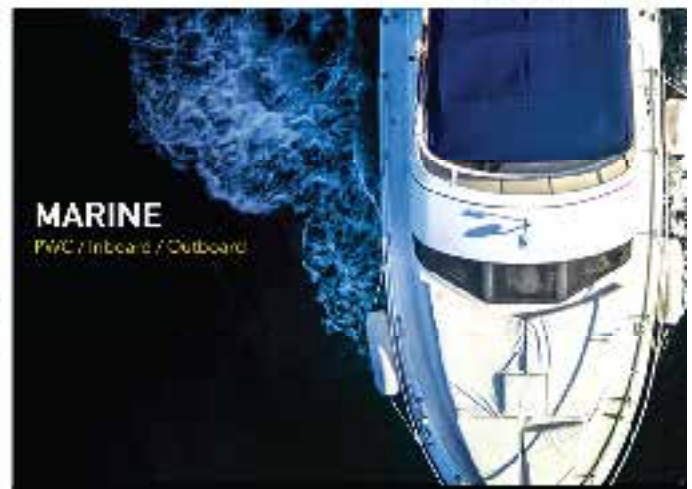



8090 Auburn Road • Concord, OH 44077

1 (440) 354-0777 • 1 (800) 752-9850

1 (440) 354-0350

info@cometic.com

www.cometic.com

facebook.com/cometic

@cometicgasket



PROUD PARTNER



Copyright 2022 Cometic Gasket, Inc.

Cover photo credits: All Star Circuit of Champions

AB2022
Printed in China



California, Proposition 65 Warning. The state of California has determined that certain chemicals used in the manufacture of this product have been known to cause cancer and birth defects. For more information, visit www.p65Warnings.ca.gov

